





Complete chain grip kit
Ready to use
See page 23



SOFTEYE 40 STICK-ON PADEYE
Do like the Pros!
See page 12



New range of fairlead folding padeyes
See page 13



Fixed round padeyes: 2 larger models
Outstanding mechanical resistance
High corrosion resistance
See page 16



Snatch blocks: new larger models
See page 47



New 12 mm shackles
2 versions: self-locking pin & captive pin
See pages 29 & 30

| | |
|--|------------|
| WICHARD | p. 4 7 |
| STAINLESS STEEL PRODUCTS | p. 8 32 |
| RIG ADJUSTERS AND WIRE ACCESSORIES | p. 9 11 |
| Babystay adjusters | p. 9 |
| Backstay adjusters, accessories for babystay adjusters, foldable mast step, sail chafe protector | p. 10 |
| Lifeline hooks | p. 11 |
| FASTENINGS | p. 12 16 |
| Folding pad eyes | p. 13 |
| Toe rail pad eyes and watertight U-bolts | p. 14 |
| Eye nuts, eye straps and eye bolts | p. 15 |
| Fixed pad eyes | p. 16 |
| SNAP HOOKS | p. 17 24 |
| Snap shackles | p. 18 |
| Trigger snap shackles | p. 19 |
| Quick release snap shackles & opening pre feeder | p. 20 |
| Snap hooks | p. 21 |
| Carbine hooks, one hand sail snaps | p. 22 |
| Mooring hooks, chain grips, rings and adjusters | p. 23 24 |
| SWIVELS | p. 25 26 |
| SHACKLES | p. 27 32 |
| Standard self-locking shackles | p. 29 |
| Captive pin shackles, key pin shackles, thimble shackles | p. 30 |
| «HR» and Titanium shackles - Soft shackle SoftLink - Accessories & maintenance | p.31 32 |
| BLOCKS | p.33 48 |
| FRX: rings | p.35 |
| MXLEvo soft block, MXEvo one-piece block | p. 36 47 |
| Stainless steel blocks - Ball bearing blocks and plain bearing blocks | p. 38 43 |
| Roller blocks | p. 44 46 |
| Snatch blocks | p. 47 |
| Deck accessories | p. 48 |
| SAFETY | p. 49 54 |
| Gyb'Easy: boom brake | p. 50 |
| Lyf'Safe jacklines | p.51 |
| Proline and Proline'R tethers | p. 52 53 |
| Tethers : with double action safety hook and carabiner - Tethers with quick opening snap shackle | p. 54 |
| WICHARD KNIVES: Offshore -Rescue - Aquaterra | p. 55 59 |
| SAILING ACCESSORIES | p. 60 61 |
| SUPPLEMENTARY PRODUCTS | p.62 65 |
| Fortress anchors - anti torque cable | p.62 63 |
| PEGUET quick links | p.64 |
| TECHNICAL INFORMATION | p.65 66 |
| CONTACT | p.67 |

It all started in 1919 - or maybe a bit earlier!

Before becoming a foundry and taking on the name Wichard, the historic factory was initially called the Croix de Fer (or Iron Cross) factory and was actually a paper mill.

The mill owed its name to a forged Iron Cross that was known as 'the paper mill's cross'.

In 1887, the owner at the time sold his establishment to Messrs Bizet and Pradel, who converted it into a cutlery factory.

In 1919, Antoine Bizet formed a partnership with a certain Henri Wichard, setting up a company that would "specialise in the production of everything for the cutlery

industry and locksmithing using processes such as cutting and stamping".

The latter, a blacksmith by trade from a long line of master smiths from eastern France, added his expertise.

Henri Wichard & Co was born.

Up until the end of the Second World War, Wichard forged knife tangs and blades, scissors and components used in the hunting rifles produced by the St Etienne arms factory.



1887: The Croix de Fer paper mill becomes a cutlery factory owned by Bizet and Pradel.



The factory is converted and expanded, including the installation of blade sharpeners, polishers and handle makers.



Antoine Bizet forms a partnership with Henri Wichard - The company Henri Wichard & Co is founded at the Croix de Fer factory



1st catalogue for marine hardware - development of the 2480 snap hook



Range of shackles - developed alongside Bernard Moitessier

2nd production site
An automatic forging line is put in place.
Development of deck fitting products and the titanium forge (medical)

Products: Snap hooks

1984: Nouvel Economiste - Europe 1: Award for design: Quick release snap shackle



Folding pad eyes



Wichard blocks are added to the catalogue



Double safety snap hooks given 1st prize at the Dame Award - Safety tethers



1980

1984

1988

1990

1995

1998

Development of international network

Products: One hand sail snaps, eye bolts, saddles, lifeline hooks, folding pad eyes

The American subsidiary is created: Wichard inc

Takeover of Maillard (plastic injection), who would produce Wichard blocks

Products: turnbuckles, U-bolts, watertight U-bolts, double folding pad eyes, Wichard blocks, safety tethers

2000

Wichard is taken over by a group of private shareholders -

The Australian subsidiary Wichard Pacific is founded, takeover of Forginox, a cutlery factory in Thiers.

All activity is brought together at one single site within an industrial estate. The introduction of a high-speed machining platform for the development of production machinery, the deployment of a new forging press, the installation of a 5-axe machining centre

Products: trigger snap shackles, roller blocks, boom brake, jacklines

2010



Products : Proline safety tethers Offshore and Aquaterra knife ranges, maintenance products

2013

Proline: new range of safety tethers



2015



Offshore & Aquaterra knife ranges

2019

Wichard celebrated its 100th anniversary



The forge - our trade yesterday, our trade tomorrow

Produced in France since 1919, the trade of the blacksmith has undergone significant changes, but it remains a trade for men and enthusiasts. At Wichard, we manage the entire process, from the production of equipment and stamping right through to packaging. Our expertise is passed on throughout the company and we are proud to have kept all of our manufacturing in France.



Why choose a Wichard forged product?



Proven corrosion resistance



Enhanced mechanical and fatigue resistance



High quality manufacturing



Reliability guaranteed

Our manufacturing process: -always manual, always meticulous

There are a significant number of steps involved in the development of each forged Wichard product. For our iconic 2480 snap hook, for example, 21 steps are involved, with the majority of these carried out by a Wichard employee.

The main production steps for forged products are as follows:



Expertise handed down from generation to generation and innovative development.

Although our expertise has been handed down from one generation to the next, we design and manufacture all of our new products in an innovative and contemporary way.

Our design department innovates by using modern methods for development and prototyping.

At the same time, we work to ensure both our expertise and our production methods evolve in order to keep pace with developments in the yachting market.



Wichard quality is what matters most

Our shared goal is to offer our clients products that provide the very best when it comes to safety and quality. In order to ensure this, we deploy a quality control procedure for each batch of manufactured components:

Test/traction bench for mechanical resistance



Dimensional checks



Drop tests for our safety tethers



During the 2000s, following a decision taken by upper management and private shareholders, Wichard became a group incorporating a number of different trades, with more than 250 employees in France in 2019. Through these

various acquisitions, the Wichard Group is aiming to become a major player in yachting, particularly through the group's two subsidiaries in the USA and in Australia.



Our brands

| | | | | | | |
|--|---|--|--|-------------------------|--------------------------|--|
| | | | | | | |
| Thiers Forged marine hardware, sail furling systems | St Vaast la Hougue - La Rochelle Aluminium masts | St Malo Injection of plastic components | St Vaast la Hougue Sail furling systems | Lorient Carbon masts | Annemasse Quick links | |

Protecting the environment



At Wichard, we don't simply pay lip service to environmental protection. When manufacturing our knives, we do everything practical to contribute to Protecting nature on a daily basis:

Respect all applicable environmental requirements

Take active measures to prevent pollution.

Design products that preserve environment and are recyclable

Reducing the manufacturing of sub-standard items, especially waste.

- Producing no more than is required.
- Minimize the environmental impact of its sites by:
 - limiting the consumption of raw materials and energy;
 - using clean manufacturing processes;
 - avoiding the discharge of any material that may pollute the soil, air or waterways and treating its waste effectively.
- Involve its partners and collaborators in its improvement process.



Stainless steel products



Wichard offers a complete range of stainless steel products including:

- Babystay adjusters, backstay adjusters.
- Wire accessories: lifeline hooks.
- Fastenings: folding pad eyes, watertight U-bolts.
- Eye straps, eye nuts and eye bolts.
- Snap hooks and swivels.
- Shackles.

Babystay adjusters



For fitting a jib, setting up a genoa or a solent jib... Both for safety and performance reasons, fitting a removable inner forestay is strongly recommended when there is a roller furling system. Wichard offers a whole range of babystay adjusters. The table below will allow you to determine the best suitable product for your boat.

+ BENEFITS

- Large range of babystay adjusters
- Available with wheel, handle or ratchet
- Ergonomic and comfortable to use
- Easy to install and dismantle
- Forged body and snap hook
- Resistant to high loads
- Perfect for setting a flying sail (solent jib or storm jib)
- Optimizes yacht performance
- Long travel model available

| N° | Part # | Length pin to pin closed/open mm | Toggle length x width mm | Ø pin mm | Handling Kg | W.L. Kg | B.L. Kg | Ø stud mm | For wire Ø mm | Weight Kg |
|--|--------|----------------------------------|--------------------------|----------|-------------|---------|---------|-----------|---------------|-----------|
| WITH WHEEL (DELIVERED WITH SHACKLE PART # 1206) | | | | | | | | | | |
| 1 | 5546 | 250 / 310 | 15 x 20 | 12 | 1200 | 2800 | 5300 | 12 | 5/6/7 | 1.090 |
| WITH HANDLE | | | | | | | | | | |
| 2 | 5554 | 310 / 450 | 10 x 10 | 8 | 800 | 960 | 2400 | 8 | 4/5 | 0.802 |
| 3 | 5556 | 450 / 510 | 15 x 20 | 12 | 1200 | 2800 | 5100 | 12 | 5/6/7 | 1.268 |
| 4 | 5566 | 370 / 540 | 15 x 20 | 12 | 1200 | 2800 | 5000 | 12 | 5/6/7 | 1.390 |
| WITH RATCHET | | | | | | | | | | |
| 5 | 5585 | 360 / 520 | 17 x 22 | 12 | 2500 | 3200 | 6000 | 14 | 7/8/9 | 1.848 |
| | 5587 | 360 / 520 | 17 x 22 | 14 | 2500 | 3200 | 6700 | 14 | 7/8/9 | 1.856 |
| | 5588 | 415 / 615 | 18 x 25 | 16 | 2500 | 3200 | 9000 | 16 | 9/10 | 2.862 |



1



2



3



4



5

SELECTION CHART OF BABYSTAY ADJUSTERS PER SIZE OF BOAT

| Length in m | | 6 to 7.60 | 7.60 to 9.00 | 9.00 to 10.00 | 10.00 to 10.70 | 10.70 to 11.15 | 11.50 to 12.00 | 12.00 to 13.60 | 13.60 to 14.50 |
|--------------|----------------|-----------|-------------------|-------------------|----------------|----------------|----------------|----------------|----------------|
| Length in ft | | 20 to 25 | 25 to 30 | 30 to 33 | 33 to 35 | 35 to 38 | 38 to 40 | 40 to 45 | 45 to 48 |
| Head stay | Removable stay | | | | | | | | |
| 5 mm | 4 mm | 5554 | 5554 | | | | | | |
| 6 mm | 5 mm | 5554 | 5546/5556 5566 | 5546/5556 5566 | | | | | |
| 7 mm | 6 mm | 5546/5556 | 5556/5566 | 5556/5566 | 5566 | | | | |
| 8 mm | 7 mm | 5546/5556 | 5566/5587 5585 | 5587/5585 | 5587/5585 | 5587/5585 | 5587/5585 | 5587/5585 | 5587/5585 |
| 9 mm | 8 mm | | 5587/5585 | 5587/5585 | 5587/5585 | 5587/5585 | 5587/5585 | 5587/5585 | 5587/5585 |
| 10 mm | 9 mm | | 5587/5585 | 5587/5585 | 5587/5585 | 5587/5585 | 5587/5588 | 5588 | 5588 |
| 12 mm | 10 mm | | | 5588 | 5588 | 5588 | 5588 | 5588 | 5588 |

These indications are not contractual, as each boat is different, we recommend checking with a professional.

WL: working load - BL: breaking load

ACCESSORIES for babystay attachment

| N° | Part # | Description | Weight kg |
|----|--------|--|-----------|
| 1 | 9150 | Babystay tang , to be fitted to the mast | 0.306 |
| 2 | 6564 | Double folding pad eye dia 6 (see page 13) | 0.126 |
| | 6565 | Double folding pad eye dia 8 (see page 13) | 0.252 |
| | 6566 | Double folding pad eye dia 10 (see page 13) | 0.494 |
| 3 | 9204 | Eye strap, used as a backing plate for double pad eye part #6564 & 6565 (see page 13) | 0.038 |
| | 9205 | Eye strap, used as a backing plate for double pad eye part #6566 (see page 13) | 0.075 |
| 4 | 6435 | Threaded eye hook for tensioning. Breaking load 1000 kg (small yachts). Length: 450 mm - M10 | 0.254 |

Wichard offers a comprehensive range of fixing points for babystay attachment. Double pad eye allows a single attachment point for both the babystay pelican adjuster and the jib tack point, fits all sizes of adjusters.



Backstay adjusters

| N° | Part # | Length pin to pin Closed/open mm | Togglelength x width mm | Ø pin mm | Handling mm | W.L. Kg | B.L. Kg | Ø Stud mm | For wire Ø mm | Weight Kg | |
|---------------------|--------|----------------------------------|-------------------------|----------|-------------|---------|---------|-----------|---------------|-----------|--|
| WITH WHEEL | | | | | | | | | | | |
| 5 | 5526 | 350 / 520 | 15 x 20 | 12 | 1200 | 2800 | 5300 | 12 | 5/6/7 | 1.128 | |
| WITH HANDLE | | | | | | | | | | | |
| 6 | 5536 | 350 / 520 | 15 x 20 | 12 | 1200 | 2800 | 5300 | 12 | 5/6/7 | 1.306 | |
| WITH RATCHET | | | | | | | | | | | |
| 7 | 5565 | 440 / 660 | 17 x 22 | 12 | 2500 | 3200 | 5000 | 14 | 7/8/9 | 2.052 | |
| | 5567 | 440 / 660 | 17 x 22 | 14 | 2500 | 4400 | 6700 | 14 | 7/8/9 | 2.088 | |
| | 5568 | 505 / 755 | 18 x 25 | 16 | 2500 | 5600 | 9000 | 16 | 9/10 | 3.264 | |

+ BENEFITS

- Available with wheel, handle or ratchet
- Ergonomic and comfortable to use
- Optimizes rigging performance
- Compact size
- Forged body
- Resistant to high loads



Foldable mast step

+ BENEFITS

- Quick and easy to install without need to modify the base
- Locks in place for maximum security
- The notched surface and end piece ensure a strong, stable support for your feet and reduce risk of slipping
- UV resistant, corrosion-free
- Lightweight: extra weight in the upper sections.
- SWL: 140 Kg
- Colour: grey

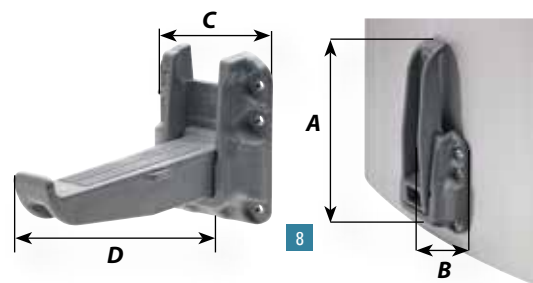

| N° | Part # | A mm | B mm | C mm | D mm | Weight Kg |
|---------------------------|--------|------|------|------|------|-----------|
| FOLDABLE MAST STEP | | | | | | |
| 8 | 5100 | 173 | 36 | 70 | 154 | 0,190 |

Sail chafe protector

SAIL CHAFE PROTECTOR

- 9 4107 This two part ring which is suitable for clipping on to 6 to 10 mm diameter wires, protects sails and facilitates manoeuvring whilst minimising snagging risks; Overall diameter 70 mm

WL: working load - BL: breaking load



Lifeline hooks



Automatic locking

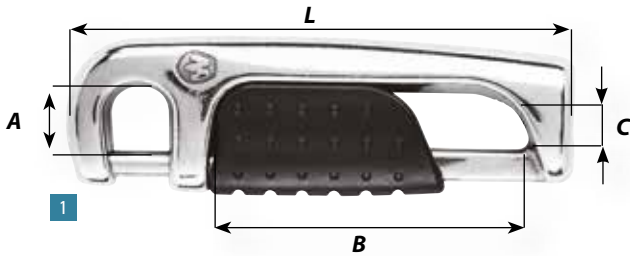

| N° | Part # | Length mm (L) | A mm | B mm | C mm | W.L. Kg | B.L. Kg | Weight Kg |
|--|--------|---------------|------|------|--------|---------|---------|-----------|
| AUTOMATIC LOCKING LIFELINE HOOK | | | | | | | | |
| 1 | 2834 | 91 | 11 | 55 | M6x100 | 640 | 1500 | 0,102 |
| | 2835 | 91 | 11 | 55 | M8x125 | 640 | 1500 | 0,102 |

+ TECHNIQUE

- Automatic locking lifeline hook
- Only takes one hand to operate
- Forged Duplex stainless steel body - composite injection trigger (PBT) - 316L spring and piston
- Extremely strong, UV resistant and corrosion free
- Compact and lightweight
- For M6 and M8 lifelines

Standard locking

+ BENEFITS

- Registered design
- Forged in 316L stainless steel
- For closing lifelines gate
- Off-centre shape allows the wires to be tensioned easily



| N° | Part # | Length mm | A mm | B mm | C mm | Tension mm | W.L. Kg | B.L. Kg | Weight Kg |
|---------------------------------|--------|-----------|------|------|-----------|------------|---------|---------|-----------|
| PELICAN HOOKS «PATENTED» | | | | | | | | | |
| 2 | 12836 | 170 | 20 | 18 | M12 x 175 | 28 | 2400 | 6500 | 0.558 |
| | 12837 | 170 | 20 | 18 | M14 x 200 | 28 | 3200 | 6500 | 0.534 |
| 3 | 2831 | 100 | 16 | 48 | M8 x 125 | 22 | 640 | 2300 | 0.106 |

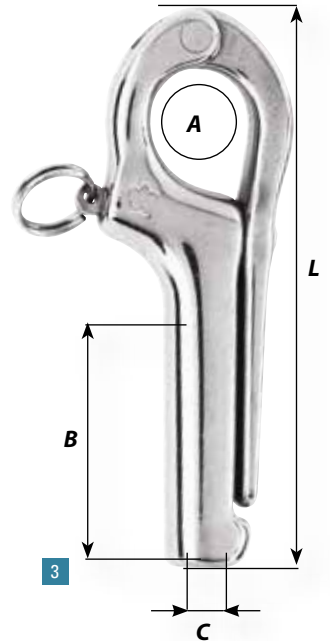

Swage studs & wire grips

| N° | Part # | A mm | B mm | C mm | D mm | E mm | For wire Ø mm | Weight Kg |
|--|--------|------|------|------|----------|------|---------------|-----------|
| SWAGE STUDS (FOR PART # 2831 ET 2833) | | | | | | | | |
| 4 | 7802 | 7,5 | 40 | 4,3 | M8 x 125 | 40 | 4 | 0.036 |
| | 7803 | 9 | 40 | 5,3 | M8 x 125 | 48 | 5 | 0.042 |
| | 7804 | 11 | 40 | 6,3 | M8 x 125 | 56 | 6 | 0.056 |

| N° | Part # | For wire Ø mm | A mm | B mm | P mm (min/max) | Weight Kg |
|-------------------|--------|---------------|------|------|----------------|-----------|
| WIRE GRIPS | | | | | | |
| 5 | 7304 | 3-5 | 5 | | M4 x 70 | 2/9 |
| | 7306 | 5-6 | 7 | | M5 x 90 | 4/13 |
| | 7308 | 7-8 | 9 | | M6 x 100 | 6/17 |
| | 7310 | 10 | 11 | | M8 x 125 | 8/21 |
| | 7312 | 12 | 13 | | M8 x 125 | 10/26 |

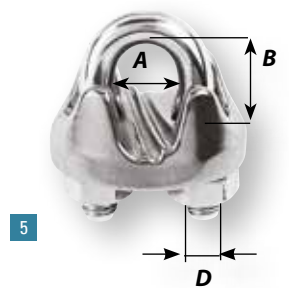
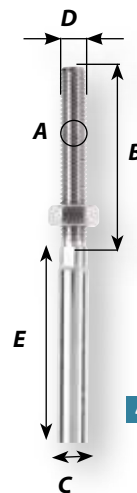

WL: working load - BL: breaking load



Fastenings



SOFTEYE 40 STICK ON PADEYE

Do like the Pros!

- Easy installation - no drilling required
- Compact & light
- Applications: Lee cloth, rope retainers, equipment storage etc..
- Materials: Dyneema®, reinforced plastic, fiber glass
- Glue type: Sika 292i or Epoxy.*

Wichard padeyes: Choose the original!

Only Wichard padeyes are completely forged. They are 100% safe, highly resistant to corrosion and their design is suitable for all types of boats.

Wichard offers a wide range of padeyes:

- Folding padeyes in stainless steel or titanium.
- Toe rail padeyes.
- U-bolts.
- Watertight U-bolts.

| N° | Part # | Ø A mm | B mm | L mm | Ø rope mm | *W.L. Kg | *B.L. Kg | Weight Kg |
|---|--------|--------|------|------|-----------|----------|----------|-----------|
| SOFTEYE 40 - STICK-ON PADEYE - WHITE | | | | | | | | |
| 1 | 6661 | 40 | 3 | 20 | 3 | 80 | 150 | 0.008 |



*Indicated loads are for Sika glue installation

Folding padeyes

+ BENEFITS

- Made in France
- Hot forged
- Available in single and double models
- Available in 316L/17.4 Ph s/s or Titanium
- Outstanding working loads in all position
- Compact, can be folded
- Silicon pad to reduce noise and vibrations
- Aesthetic
- Multi-use: fastening, shrouds, blocks, jackstays etc...

| N° | Part # | Ø D mm | A mm | B mm | C mm | Ø d mm | D mm | E mm | F mm | W.L. Kg | B.L. Kg | Weight Kg |
|---|--------|--------|------|------|---------|--------|------|------|------|---------|---------|-----------|
| FOLDING PADEYE - INCL. SILICON PAD | | | | | | | | | | | | |
| 1 | 6684 | 6 | 40 | 23.4 | mini 15 | 7 | - | 40 | - | 750 | 1600 | 0.056 |
| 2 | 6604 | 6 | 45 | 27 | 15 | 6 | 44 | 41 | 27 | 1440 | 3000 | 0.078 |
| 2 | 6605 | 8 | 57 | 35 | 18 | 8 | 59 | 51 | 35 | 2400 | 5000 | 0.165 |
| 2 | 6606 | 10 | 75 | 45 | 25 | 10 | 80 | 68 | 45 | 4080 | 9000 | 0.355 |

| N° | Part # | Ø D mm | A mm | B mm | C mm | Ø d mm | E mm | W.L. Kg | B.L. Kg | Weight Kg |
|---|--------|--------|------|------|------|--------|------|---------|---------|-----------|
| TITANIUM FOLDING PADEYE «PATENTED» | | | | | | | | | | |
| 2 | 56504 | 6 | 45 | 27 | 14 | 6,4 | 40 | 1600 | 3000 | 0.040 |
| 2 | 56505 | 8 | 59 | 35 | 17 | 8,5 | 50 | 2720 | 5000 | 0.080 |
| 2 | 56506 | 10 | 75 | 45 | 23 | 10.5 | 65 | 4560 | 8500 | 0.174 |

The Wichard double folding padeyes have been designed to attach several shrouds or a removable stay.

| N° | Part # | Ø D mm | A mm | B mm | C mm | Ø d mm | E mm | F mm | W.L. Kg | B.L. Kg | Weight Kg |
|------------------------------|--------|--------|------|------|------|--------|------|------|---------|---------|-----------|
| DOUBLE FOLDING PADEYE | | | | | | | | | | | |
| 3 | 6564 | 6 | 45 | 27 | 14 | 6,4 | 75 | 59 | 1440 | 2500 | 0.126 |
| 3 | 6565 | 8 | 59 | 35 | 17 | 8,5 | 81 | 59 | 2400 | 4300 | 0.252 |
| 3 | 6566 | 10 | 75 | 45 | 23 | 10.5 | 104 | 78 | 4560 | 9000 | 0.494 |

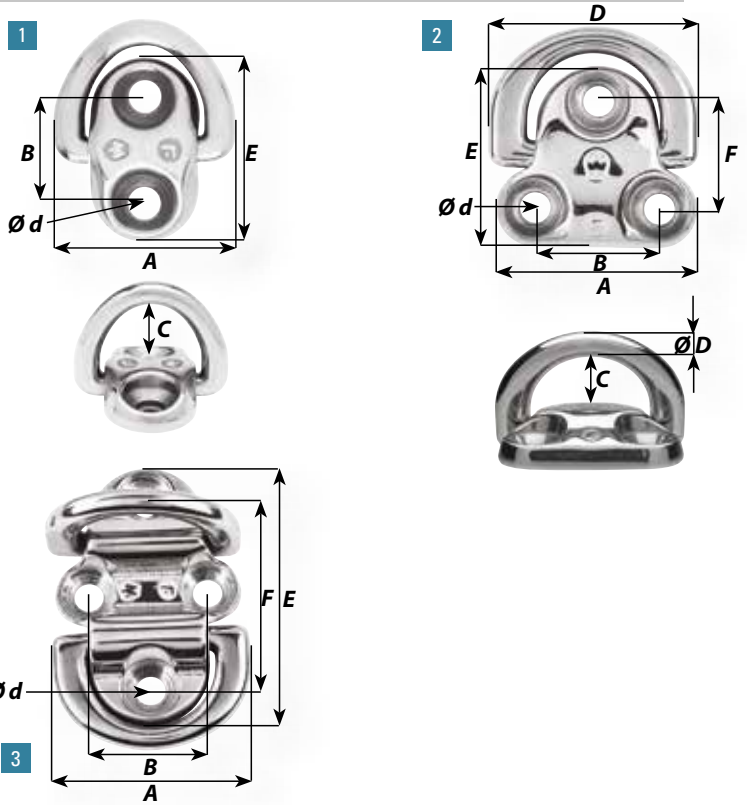

+ BENEFITS

- 3 models available
- Becket feature for 2/1 purchase
- Optimized design to prevent rope wear
- Reduced footprint (less assembly parts)

- Applications:

flying sail furler tensioning, inhauler trimming, removable stay...

- Can not be used for structural applications



| N° | Part # | Ø D mm | A mm | B mm | C mm | Ø d mm | D mm | E mm | F mm | G mm | Ø H mm | Ø rope mm | W.L. Kg | B.L. Kg | Weight Kg |
|--------------------------------|--------|--------|------|------|------|--------|------|------|------|------|--------|-----------|---------|---------|-----------|
| FAIRLEAD FOLDING PADEYE | | | | | | | | | | | | | | | |
| 4 | 6614 | 6 | 45 | 27 | 17 | 6 | 44 | 41 | 23 | 22 | 6 | 8 | 1200 | 2400 | 0.102 |
| 4 | 6615 | 8 | 57 | 35 | 21,5 | 8 | 59 | 51 | 30 | 27 | 8 | 10 | 2100 | 4200 | 0.225 |
| 4 | 6616 | 10 | 75 | 45 | 26 | 10 | 81 | 68 | 39 | 32 | 10 | 12 | 3200 | 6400 | 0.453 |

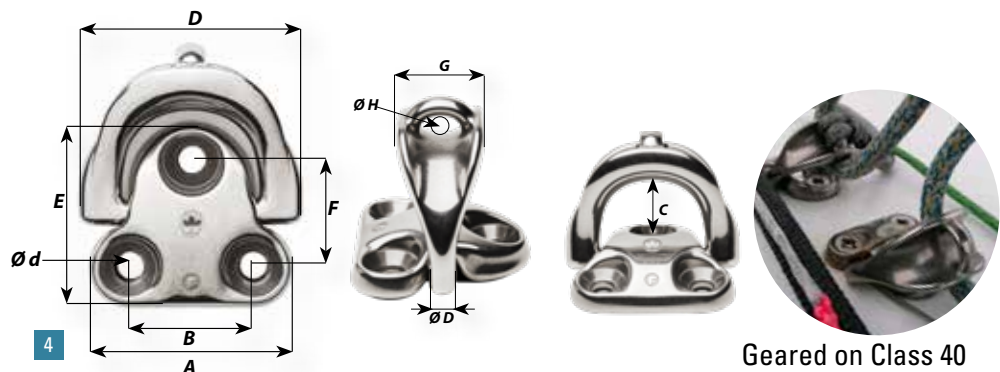

Geared on Class 40

Toe rail pad eyes - U-Bolts pad eyes

Using these sliding padeyes, the toe rail can be used without any risk of damage, for a wide range of applications, such as attaching running rigging, barber hauler, boom brake, kicking strap, or mooring/fender line guide when docked.

| N° | Part # | Toe rail | Ø A mini - maxi mm | H mini mm | C mini - maxi mm | D mm | W.L. Kg | B.L. Kg | Weight Kg |
|-------------------------------------|--------|-----------|--------------------------|-----------------|------------------------|---------|------------|------------|--------------|
| TOE RAIL PAD EYES «PATENTED» | | | | | | | | | |
| 1 | 16613 | Standard | 9-13 | 40 | 2-4 | 14 | 960 | 3000 | 0.186 |
| | 16614 | Asymetric | 9-13 | 40 | 2-5 | 14 | 960 | 3000 | 0.186 |

| N° | Part # | D mm | L mm | A mm | B mm | C mm | W.L. Kg | B.L. Kg | Max tightening torque Nm | Weight Kg |
|----------------|--------|---------|---------|---------|---------|---------|------------|------------|--------------------------------|--------------|
| U-BOLTS | | | | | | | | | | |
| 2 | 6511 | 4 | 50 | 24 | 21 | 27 | 480 | 1000 | 2,3 | 0.022 |
| | 6512 | 5 | 60 | 28 | 24 | 30 | 640 | 2000 | 4,5 | 0.035 |
| | 6513 | 6 | 70 | 32 | 27 | 35 | 1280 | 3000 | 7,5 | 0.060 |
| | 6523 | 6 | 90 | 32 | 27 | 55 | 1280 | 3000 | 7,5 | 0.067 |
| | 6514 | 8 | 80 | 36 | 30 | 40 | 2400 | 4800 | 18 | 0.114 |
| | 6524 | 8 | 100 | 36 | 30 | 60 | 2400 | 4800 | 18 | 0.127 |
| | 6515 | 10 | 90 | 40 | 32 | 45 | 3600 | 7000 | 36 | 0.200 |
| | 6525 | 10 | 110 | 40 | 32 | 65 | 3600 | 7000 | 36 | 0.222 |
| | 6516 | 12 | 110 | 44 | 34 | 50 | 6400 | 10000 | 60 | 0.319 |
| | 6526 | 12 | 130 | 44 | 34 | 70 | 6400 | 10000 | 60 | 0.349 |

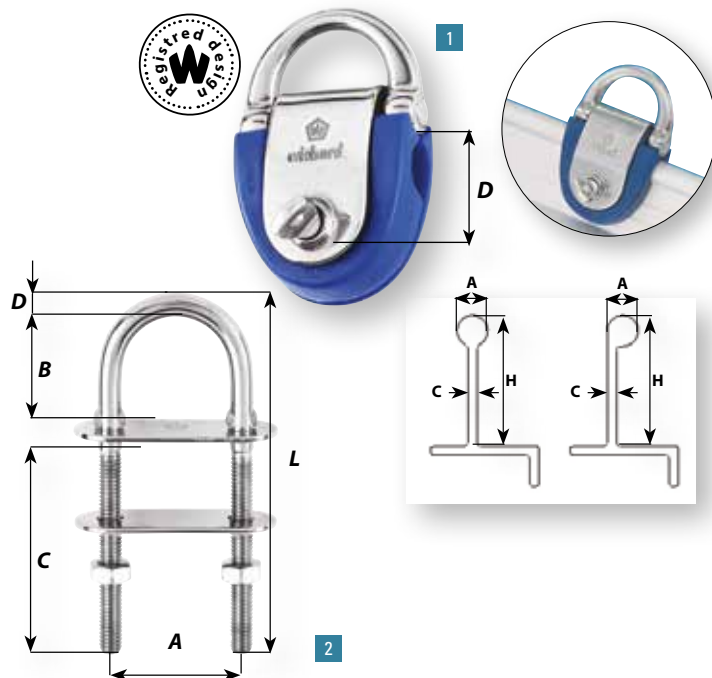

Watertight U-bolts

+ BENEFITS

- Registered design - Made in France
- Outstanding working loads
- UV-resistant rubber collar
- Complete watertightness guaranteed
- Available in black and white
- Eliminates need to install watertight seal
- Aesthetically pleasing solution
- Delivered with nuts and counterplate

| N° | Part # black | Part # white | D mm | L mm | A mm | B mm | C mm | W.L. Kg | B.L. Kg | Max tightening torque Nm | Weight Kg |
|--------------------------------------|-----------------|-----------------|---------|---------|---------|---------|---------|------------|------------|--------------------------------|--------------|
| WATERTIGHT U-BOLTS «PATENTED» | | | | | | | | | | | |
| 3 | 65321 | 65322 | 5 | 60 | 28 | 21 | 30 | 640 | 2000 | 4,5 | 0.035 |
| | 65331 | 65332 | 6 | 70 | 32 | 24 | 35 | 1280 | 3000 | 7,5 | 0.060 |
| | 65431 | 65432 | 6 | 90 | 32 | 24 | 55 | 1280 | 3000 | 7,5 | 0.068 |
| | 65341 | 65342 | 8 | 80 | 36 | 25 | 40 | 2400 | 4800 | 18 | 0.123 |
| | 65441 | 65442 | 8 | 100 | 36 | 25 | 60 | 2400 | 4800 | 18 | 0.136 |
| | 65351 | 65352 | 10 | 90 | 40 | 26 | 45 | 3600 | 7000 | 36 | 0.219 |
| | 65451 | 65452 | 10 | 110 | 40 | 26 | 65 | 3600 | 7000 | 36 | 0.238 |
| | 65361 | 65362 | 12 | 110 | 44 | 27 | 50 | 6400 | 10000 | 60 | 0.345 |
| | 65461 | 65462 | 12 | 130 | 44 | 27 | 70 | 6400 | 10000 | 60 | 0.375 |

WL: working load - BL: breaking load

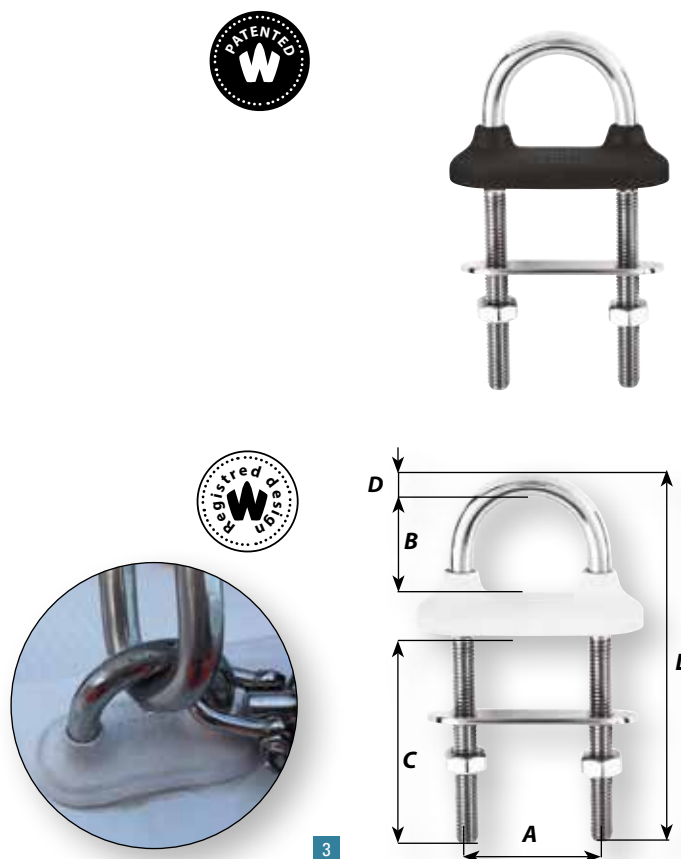

Eye straps



+ BENEFITS

- Hot forged with 316L stainless steel
- High resistance
- Round shape to prevent wear to straps, lines etc...
- Multi-use

| N° | Part # | Ø D mm | A mm | B mm | E mm | B.L. Kg | Weight Kg |
|----------------|--------|--------|------|------|------|---------|-----------|
| SADDLES | | | | | | | |
| 1 | 9201 | 4 | 8 | 11 | 32 | 650 | 0.004 |
| | 9202 | 5 | 10 | 14 | 37,5 | 1800 | 0.009 |
| | 9203 | 6 | 12 | 16 | 45 | 2400 | 0.016 |
| | 9204 | 8 | 16 | 21 | 60 | 3500 | 0.038 |
| | 9205 | 10 | 20 | 26 | 78 | 7000 | 0.075 |

| N° | Part # | Ø D mm | A mm | B mm | E mm | Weight Kg |
|---------------------------|--------|--------|------|------|------|-----------|
| WEBBING EYE STRAPS | | | | | | |
| 2 | 9211 | 4 | 28 | 5 | 56 | 0.007 |
| | 9212 | 5 | 34 | 10 | 65 | 0.013 |
| | 9222 | 5 | 50 | 12 | 86 | 0.018 |

| N° | Part # | Ø D mm | A mm | B mm | E mm | Weight Kg |
|--|--------|--------|------|------|------|-----------|
| REEFING EYE STRAP | | | | | | |
| Many purposes like reefing applications. | | | | | | |
| 3 | 9412 | 6 | 10 | 35 | 15 | 0.019 |

| N° | Part # | Ø D mm | A mm | B mm | E mm | Weight Kg |
|--|--------|--------|------|------|------|-----------|
| FLAT EYE STRAP: TO TENSION MULTIHULL TRAMPOLINE | | | | | | |
| 4 | 9413 | 7 | 12 | 50 | 18 | 0.033 |

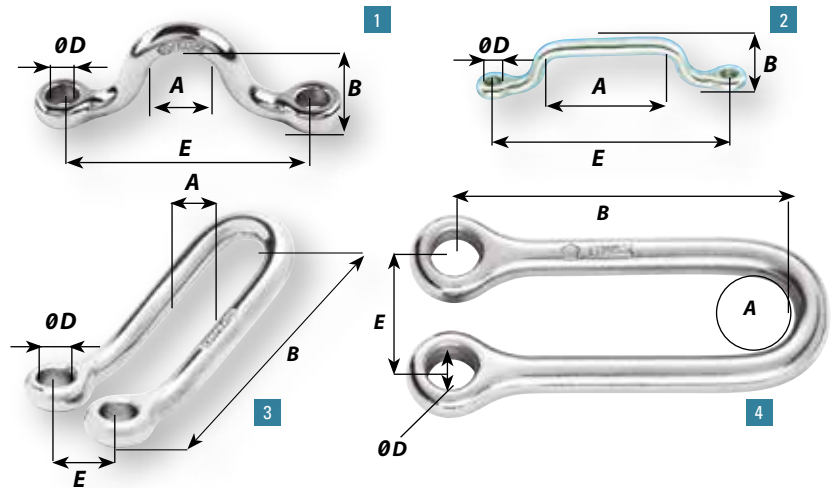

Eye nuts and eye bolts

Wichard eye nuts and eye bolts are single-piece forged components that guarantee you excellent safety standards for your fastenings. They come in a broad range of sizes, enabling you to find the solutions best suited to your circumstances. Should you wish to order large quantities with specific lengths or diameters, Wichard can also manufacture custom-made items.

| N° | Part # | A mm | B mm | C mm | D mm | E mm | F mm | G mm | W.L. Kg | B.L. Kg | Max tightening torque Nm | Weight Kg |
|------------------|--------|-----------|------|------|------|------|------|------|---------|---------|--------------------------|-----------|
| EYE BOLTS | | | | | | | | | | | | |
| 5 | 6490 | M6 x 100 | 12 | 25 | 5 | 17 | 40 | 34 | 560 | 900 | 7,5 | 0.024 |
| | 6491 | M6 x 100 | 12 | 25 | 5 | 17 | 60 | 54 | 560 | 900 | 7,5 | 0.027 |
| | 6492 | M8 x 125 | 14 | 30 | 6 | 20 | 80 | 70 | 960 | 1500 | 18 | 0.056 |
| | 6493 | M8 x 125 | 14 | 30 | 6 | 20 | 100 | 90 | 960 | 1500 | 18 | 0.061 |
| | 6495 | M10 x 150 | 16 | 36 | 7 | 25 | 100 | 88 | 1600 | 2700 | 36 | 0.098 |
| | 6497 | M12 x 175 | 18 | 41 | 8 | 28 | 120 | 105 | 2400 | 3500 | 60 | 0.163 |

| N° | Part # | A mm | B mm | C mm | D mm | E mm | *B.L. Kg | Weight Kg |
|-----------------|--------|-----------|------|------|------|------|----------|-----------|
| EYE NUTS | | | | | | | | |
| 6 | 6333 | M6 x 100 | 13 | 27 | 6 | 17 | 1500 | 0.022 |
| | 6334 | M8 x 125 | 13 | 27 | 6 | 17 | 2200 | 0.020 |
| | 6344 | M8 x 125 | 17 | 36 | 8 | 22 | 3000 | 0.051 |
| | 6345 | M10 x 150 | 17 | 36 | 8 | 22 | 4500 | 0.049 |
| | 6355 | M10 x 150 | 22 | 46 | 10 | 28 | 4800 | 0.099 |
| | 6356 | M12 x 175 | 22 | 46 | 10 | 28 | 5200 | 0.095 |
| | 6366 | M12 x 175 | 27 | 56 | 12 | 34 | 7000 | 0.175 |
| | 6367 | M14 x 200 | 27 | 56 | 12 | 34 | 9000 | 0.171 |
| | 6368 | M16 x 200 | 27 | 56 | 12 | 34 | 10000 | 0.165 |

* The strength figures given are an indication only and change according to specification of the end fitting

WL: working load - BL: breaking load

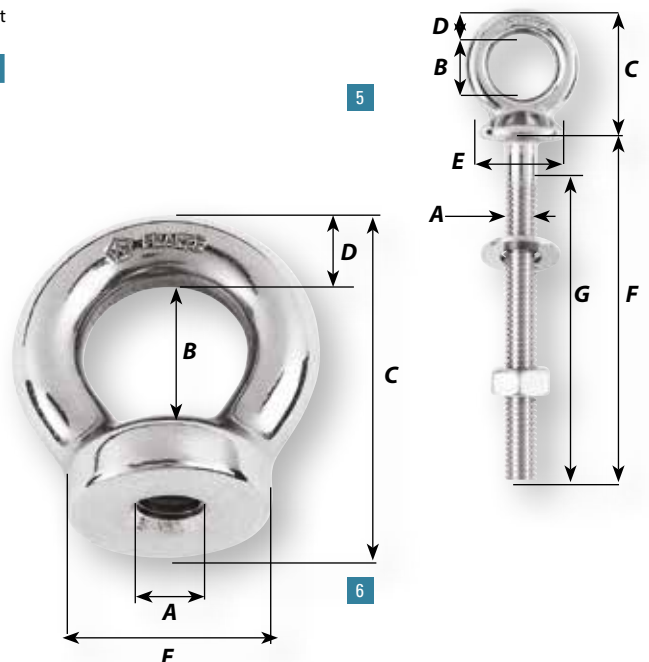

RANGE OF FIXED PADEYES

+ BENEFITS

- Multi-use : mast foot blocks, reefing blocks, various fastenings
- Mechanical resistance versus corrosion resistance ratio
- Optimized dimensions
- Rounded model for ropes and webbings
- Squared model for stainless steel fastening (fork) and webbing
- 3 sizes per model
- Material : stainless steel Duplex

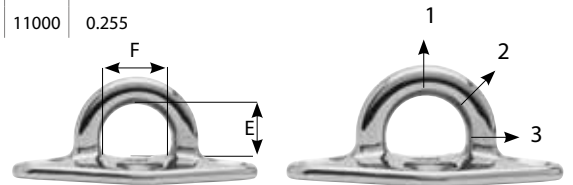
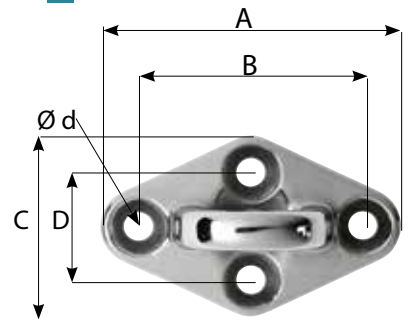

| part # | A mm | B mm | C mm | D mm | Ø d mm | E mm | F mm | W.L.1 Kg | W.L.2 Kg | W.L.3 Kg | B.L.1 Kg | B.L.2 Kg | B.L.3 Kg | Weight Kg |
|---|------|------|------|------|--------|------|------|----------|----------|----------|----------|----------|----------|-----------|
| FIXED PADEYES - ROUNDED MODEL FOR TEXTILE FASTENINGS | | | | | | | | | | | | | | |
| 1 6644 | 60 | 46 | 38 | 24 | M5 | 14.5 | 19 | 1200 | 1100 | 1100 | 3200 | 3000 | 3000 | 0.059 |
| 6645 | 79 | 60 | 50 | 32 | M6 | 18.5 | 22 | 2900 | 2600 | 2400 | 7800 | 6900 | 6300 | 0.143 |
| 6646 | 98 | 73 | 59 | 35 | M8 | 22 | 27 | 4200 | 4200 | 4100 | 11200 | 11200 | 11000 | 0.250 |

| Part # | A mm | B mm | C mm | D mm | Ø d mm | E mm | F mm | W.L.1 Kg | W.L.2 Kg | W.L.3 Kg | B.L.1 Kg | B.L.2 Kg | B.L.3 Kg | Weight Kg |
|--|------|------|------|------|--------|------|------|----------|----------|----------|----------|----------|----------|-----------|
| FIXED PADEYES - SQUARED MODEL FOR STAINLESS STEEL FASTENING | | | | | | | | | | | | | | |
| 2 6654 | 60 | 46 | 38 | 24 | M5 | 12 | 19 | 1200 | 1200 | 1100 | 3200 | 3200 | 3000 | 0.059 |
| 6655 | 79 | 60 | 50 | 32 | M6 | 15.5 | 22 | 2700 | 2600 | 2400 | 7300 | 6900 | 6300 | 0.145 |
| 6656 | 98 | 73 | 59 | 35 | M8 | 19.5 | 27 | 4300 | 4300 | 4100 | 11600 | 11600 | 11000 | 0.255 |

| part # | Ø A mm | B mm | D mm | Ø d mm | E mm | F mm | W.L.1 Kg | W.L.2 Kg | W.L.3 Kg | B.L.1 Kg | B.L.2 Kg | B.L.3 Kg | Weight Kg |
|----------------------------|--------|------|------|--------|------|------|----------|----------|----------|----------|----------|----------|-----------|
| FIXED ROUND PADEYES | | | | | | | | | | | | | |
| 3 6635 | 57 | 27 | 30 | M6 | 19 | 22 | 2300 | 2050 | 1950 | 4550 | 4100 | 3900 | 0.150 |
| 6637 | 76 | 33 | 40 | M10 | 26 | 35 | 4280 | 3760 | 3080 | 10070 | 9030 | 7430 | 0.360 |
| 6638 | 95 | 44 | 48 | M12 | 26 | 42 | 5250 | 5080 | 4360 | 12260 | 12180 | 10450 | 0,700 |

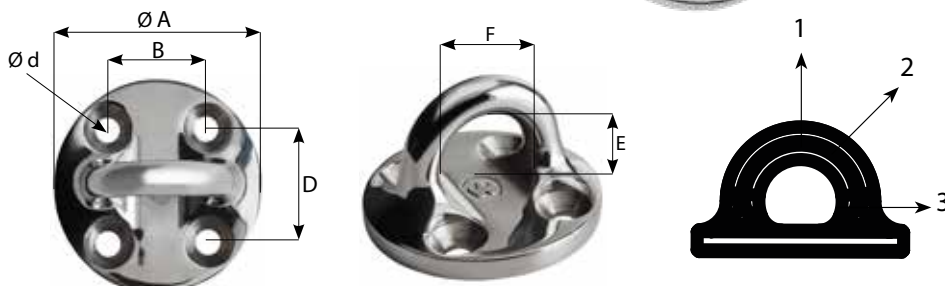

+ BENEFITS

- 3 models available
- Multi-use : reefing blocks, fastening point on bowsprit, fastening point for blocks.
- Outstanding mechanical resistance
- High corrosion resistance
- Material : Duplex stainless steel grade



Snap hooks



Whatever your application, you will always find the appropriate Wichard snap hook.

Wichard offers a complete range of snaps hooks:

- «HR» snap shackles.
- Trigger snap shackles.
- Quick release snap shackles.
- Snap hooks.
- Carbine hooks.
- Mooring hooks.

The Wichard snap hooks will never break suddenly! They show signs of deformation long before reaching the breaking point.

"HR" Shackles

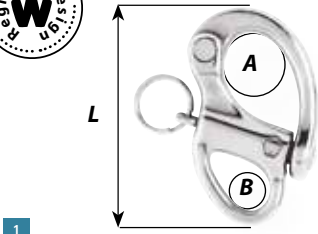

1

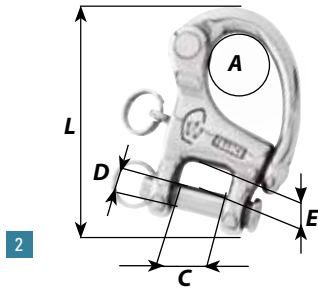

2

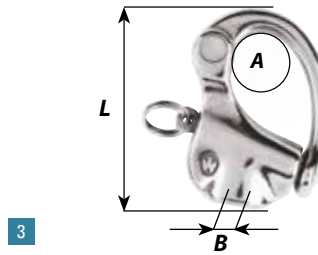

3

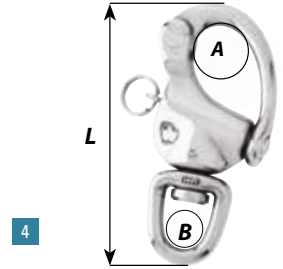

4

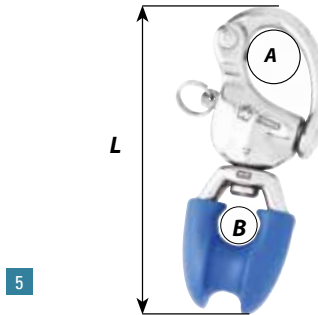

5

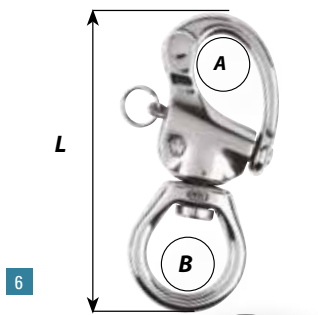

6

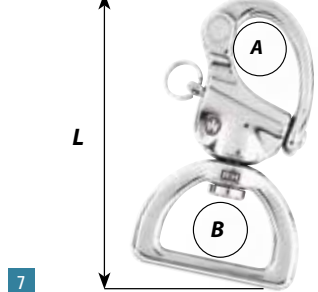

7

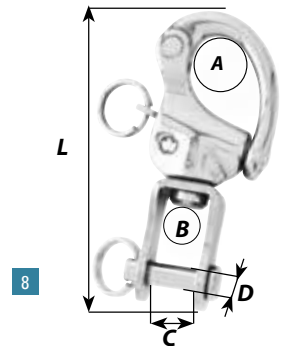

8

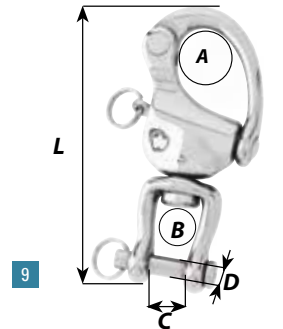

9

+ BENEFITS

- Forged in HR stainless steel
- Designed and made in France
- High resistance
- Captive plunger pin
- Large range
- Easy opening
- Multi-use: halyards, tethers etc...

| N° | Part # | Length mm | A mm | B mm | C mm | Ø D mm | E mm | W.L. Kg | B.L. Kg | Weight Kg |
|------------------|--------|-----------|------|------|------|--------|------|---------|---------|-----------|
| FIXED EYE | | | | | | | | | | |
| 1 | 2470* | 35 | 8 | 6 | | | | 160 | 400 | 0.012 |
| | 2471 | 50 | 16 | 10 | | | | 960 | 2000 | 0.042 |
| | 2472 | 70 | 21 | 13 | | | | 1280 | 3000 | 0.090 |

| N° | Part # | Length mm | A mm | Metric thread (Iso) B | W.L. Kg | B.L. Kg | Weight Kg | | | |
|-------------------|--------|-----------|------|-----------------------|---------|---------|-----------|------|------|-------|
| CLEVIS PIN | | | | | | | | | | |
| 2 | 2293 | 52 | 16 | 8 | 13 | 6 | 5,10 | 960 | 2000 | 0.054 |
| | 2295 | 70 | 21 | 11,5 | 16 | 8 | 7,80 | 1280 | 3850 | 0.130 |
| | 2297 | 86 | 26 | 14 | 21 | 10 | 9,30 | 2800 | 7000 | 0.257 |

| N° | Part # | Length mm | A mm | Metric thread (Iso) B | W.L. Kg | B.L. Kg | Weight Kg |
|--|--------|-----------|------|-----------------------|---------|---------|-----------|
| WITHOUT SWIVEL WITH FEMALE THREAD | | | | | | | |
| 3 | 72473 | 45 | 16 | M7 x 75 | | | 0.042 |
| | 72475 | 60 | 21 | M9 x 75 | | | 0.096 |
| | 72477 | 80 | 26 | M12 x 100 | | | 0.222 |

| N° | Part # | Length mm | A mm | B mm | C mm | Ø D mm | E mm | W.L. Kg | B.L. Kg | Weight Kg |
|-------------------|--------|-----------|----------|------|------|--------|------|---------|---------|-----------|
| SWIVEL EYE | | | | | | | | | | |
| 4 | 2473 | 70 | 16 | 11 | | | | 960 | 2000 | 0.065 |
| | 2475 | 90 | 21 | 14 | | | | 1280 | 3700 | 0.136 |
| | 52475* | 90 | Titanium | | | | | 1200 | 2800 | 0.094 |
| | 2477 | 120 | 26 | 21 | | | | 2800 | 7000 | 0.353 |

| N° | Part # | Length mm | A mm | B mm | W.L. Kg | B.L. Kg | Weight Kg | | |
|-------------------------|--------|-----------|------|------|---------|---------|-----------|------|-------|
| WITH THIMBLE EYE | | | | | | | | | |
| 5 | 2493 | 95 | 16 | 12 | | | 960 | 2000 | 0.076 |
| | 2495 | 110 | 21 | 14 | | | 1280 | 2400 | 0.150 |

| N° | Part # | Length mm | A mm | B mm | W.L. Kg | B.L. Kg | Weight Kg | | |
|-------------------|--------|-----------|------|------|---------|---------|-----------|------|-------|
| LARGE BAIL | | | | | | | | | |
| 6 | 2373 | 80 | 16 | 19 | | | 960 | 2000 | 0.070 |
| | 2375 | 105 | 21 | 26 | | | 1280 | 3600 | 0.160 |
| | 2377 | 140 | 26 | 35 | | | 2800 | 7500 | 0.398 |

| N° | Part # | Length mm | A mm | B mm | W.L. Kg | B.L. Kg | Weight Kg | | |
|-----------------------|--------|-----------|------|------|---------|---------|-----------|------|-------|
| WEBBING SWIVEL | | | | | | | | | |
| 7 | 2374 | 80 | 16 | 30 | | | 960 | 2000 | 0.085 |
| | 2376 | 100 | 21 | 40 | | | 1280 | 3850 | 0.170 |

| N° | Part # | Length mm | A mm | B mm | C mm | Ø D mm | E mm | W.L. Kg | B.L. Kg | Weight Kg |
|-------------------------------|--------|-----------|------|------|------|--------|------|---------|---------|-----------|
| WITH CLEVIS PIN SWIVEL | | | | | | | | | | |
| 8 | 2474 | 70 | 16 | 15 | 12 | 6 | | 800 | 1600 | 0.071 |
| 9 | 2476 | 90 | 21 | 17 | 11 | 7 | | 1280 | 3800 | 0.154 |
| 9 | 2478 | 120 | 26 | 27 | 18 | 11 | | 2400 | 7000 | 0.417 |

WL: working load - BL: breaking load

*Note parts #: 2470 and 52475 are not «HR»

Speedlink trigger snap shackle

Lightweight:

Speedlink was developed using finite element analysis software, and has an optimised design. Its shape, cut-outs and ribs make it extremely light, and give it one of the best strength/weight ratios on the market.

A modern design...

Speedlink's ultra-technical lines make it one of the most modern and efficient snap shackles available.

- The special load-bearing surface of the swivel eye avoids excessive rope wear.
- Its overall design prevents adjacent lines from jamming.

... for efficient operations

- Easy opening: opening under load, by using the release fid, is easy and effortless thanks to the generous passage diameter and its optimised slopes.
- Secure locking: the special shape of the latch reduces inertia and avoids unintentional opening, especially under impact, while the distribution of stresses limits the effort needed to open it under load.

Sturdy:

Speedlink is forged in HR stainless steel and can bear exceptional working and breaking loads for a minimum weight.

Universal eye: Halyard - Spinnaker - Peeling

+ BENEFITS

- Universal eye version
- For halyards, spinnaker sheets...
- Can handle 2 sheets or 1 sheet and 1 snap hook/shackle
- Forged in HR s/s
- Designed and made in France

Webbing eye: Tack point

+ BENEFITS

- Webbing eye version
- For foresail tack points
- Optimized design for fitting to webbing
- Forged in HR s/s
- Designed and made in France

| N° | Part # | Length mm | A mm | B mm | C mm | W.L. Kg | Weight Kg |
|----|--------|-----------|------|------|------|---------|-----------|
|----|--------|-----------|------|------|------|---------|-----------|

UNIVERSAL EYE: FOR HALYARD, SPINNAKER AND PEELING

| | | | | | | | |
|---|------|-----|----|------|--|------|-------|
| 1 | 2650 | 74 | 14 | 11,5 | | 1100 | 0.059 |
| | 2652 | 87 | 17 | 15,5 | | 1440 | 0.097 |
| | 2654 | 108 | 21 | 22 | | 2320 | 0.173 |
| | 2656 | 134 | 25 | 26 | | 4300 | 0.326 |

EYE FOR WEBBING: FOR TACK POINT APPLICATIONS

| | | | | | | | |
|---|------|-----|----|----|----|------|-------|
| 2 | 2750 | 72 | 14 | 11 | 23 | 1100 | 0.058 |
| | 2752 | 83 | 17 | 13 | 26 | 1440 | 0.095 |
| | 2754 | 102 | 21 | 17 | 35 | 2320 | 0.174 |
| | 2756 | 128 | 25 | 21 | 59 | 4300 | 0.337 |

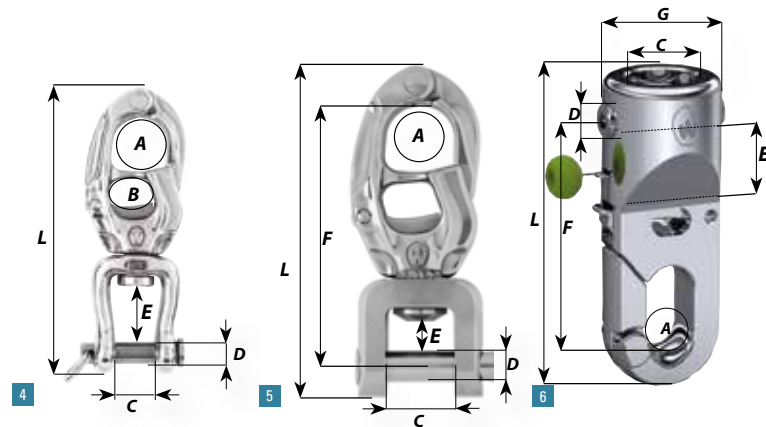

Trigger snap shackles

| N° | Part # | Length mm | A mm | B mm | C mm | D mm | E mm | W.L. Kg | Weight Kg |
|----|--------|-----------|------|------|------|------|------|---------|-----------|
|----|--------|-----------|------|------|------|------|------|---------|-----------|

SWIVEL SHACKLE (HR STAINLESS STEEL)

| | | | | | | | | | |
|---|------|-----|----|----|----|----|----|------|-------|
| 4 | 2852 | 105 | 17 | 13 | 11 | 7 | 18 | 1440 | 0.110 |
| | 2856 | 135 | 27 | 19 | 18 | 11 | 26 | 4100 | 0.360 |

| N° | Part # | Length mm | A mm | C mm | D mm | E mm | F mm | W.L. Kg | Weight Kg |
|----|--------|-----------|------|------|------|------|------|---------|-----------|
|----|--------|-----------|------|------|------|------|------|---------|-----------|

VERSION WITH FORK (HR STAINLESS STEEL)

| | | | | | | | | | |
|---|------|-----|----|----|----|-------|-----|------|-------|
| 5 | 2956 | 129 | 25 | 26 | 12 | 17.10 | 110 | 4300 | 0.400 |
|---|------|-----|----|----|----|-------|-----|------|-------|

| N° | Part # | Length mm | A mm | C mm | D mm | E mm | F mm | G mm | W.L. Kg | B.L. Kg | Weight Kg |
|----|--------|-----------|------|------|------|------|------|------|---------|---------|-----------|
|----|--------|-----------|------|------|------|------|------|------|---------|---------|-----------|

TRIGGER SNAP SHACKLE 8T

| | | | | | | | | | | | |
|---|------|-----|----|------|----|------|----|----|------|-------|-------|
| 6 | 2957 | 126 | 17 | 28.3 | 14 | 12.5 | 94 | 47 | 8000 | 13000 | 0.400 |
|---|------|-----|----|------|----|------|----|----|------|-------|-------|

WL: working load - BL: breaking load



Release fid
- anodised aluminium - Length: 15 cm - Part # 10302

Opening luff Rope Prefeeder for racing foils and furling systems

Performance

Before re-hoisting, the Bowman doesn't need to remove the headsail from the luff groove, he just has to open the prefeeder and close it around the luff tape. No need to remove the headsail anymore!

Ease of use

To open it simply push the spring with your thumb, the jaws will open automatically. To close, squeeze the jaws together between your thumb and fingers, until the spring reengages.

Features:

- Single handed operation by pushing on the spring
- Easy to install with a lashing or fixed to the forestay
- Stainless steel product benefiting from the Wichard know-how to offer the highest reliability
- Weight: 0.050 kg
- Part # 7485

Easy to install

The prefeeder can be easily installed below any headsail foil or headsail reefing configuration. In the closed position, it ensures a smooth and easy sail hoist.



Quick release snap shackles

+ BENEFITS

- Forged in HR stainless steel
- Designed and made in France
- Available with swivel eye, large eye and tack snap configuration
- Ideal for sheets (genoa, spinnaker)
- Outstanding working loads
- Control line for easy to release
- Aesthetic

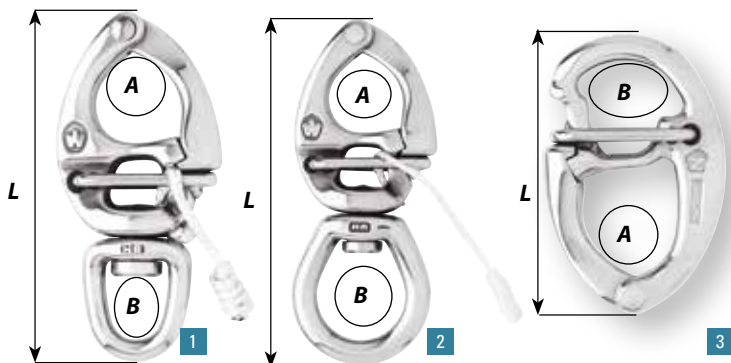

| N° | Part # | Length mm | A mm | B mm | W.L. Kg | B.L. Kg | Weight Kg |
|------------------------|--------------------------|-----------|------|------|---------|---------|-----------|
| WITH SWIVEL EYE | | | | | | | |
| 1 | 2673 | 70 | 14 | 11 | 880 | 1500 | 0.059 |
| | 2674 | 80 | 16 | 12 | 1280 | 2300 | 0.088 |
| | 2675 | 90 | 20 | 13,5 | 1600 | 3200 | 0.136 |
| | 2676 | 110 | 25 | 16 | 2400 | 4200 | 0.233 |
| | 2677 | 130 | 30 | 20 | 3200 | 6300 | 0.371 |
| | 2678 | 150 | 34 | 24 | 5200 | 9000 | 0.548 |
| | WITH LARGE BAIL | | | | | | |
| 2 | 2773 | 80 | 14 | 19 | 880 | 1300 | 0.054 |
| | 2774 | 90 | 16 | 23 | 1280 | 2000 | 0.100 |
| | 2775 | 110 | 20 | 26,5 | 1600 | 3000 | 0.160 |
| | 2776 | 120 | 25 | 31 | 2400 | 4000 | 0.271 |
| | 2777 | 145 | 30 | 35,5 | 2800 | 6300 | 0.396 |
| | 2778 | 160 | 34 | 41 | 5200 | 8000 | 0.618 |
| | TACK SNAP SHACKLE | | | | | | |
| 3 | 2575 | 70 | 20 | 25 | 1280 | 2300 | 0.095 |

Double action safety hooks

BENEFITS

- Registered design - Made in France
- Forged in 316L stainless steel
- Torsion spring
- Opens with one hand
- No risk of accidental opening
- Integrated into the Wichard tethers



| N° | Part # | Colour | Length mm | A mm | B mm | W.L. Kg | B.L. Kg | Weight Kg |
|---|--------|-------------|-----------|------|---------|---------|---------|-----------|
| DOUBLE ACTION SAFETY HOOK «PATENTED» | | | | | | | | |
| 1 | 2454 | Yellow | 115 | 18 | 19 x 10 | 1200 | 2800 | 0.126 |
| 2 | 2455 | Blue | 115 | 18 | 19 x 10 | 1200 | 2800 | 0.126 |
| 3 | 2452 | Fluorescent | 115 | 18 | 19 x 10 | 1200 | 2800 | 0.126 |

Safety snap hooks

BENEFITS

- Registered design - Made in France
- Forged in 316L or HR stainless steel
- Outstanding working loads
- Aesthetic design
- Multi-use on board

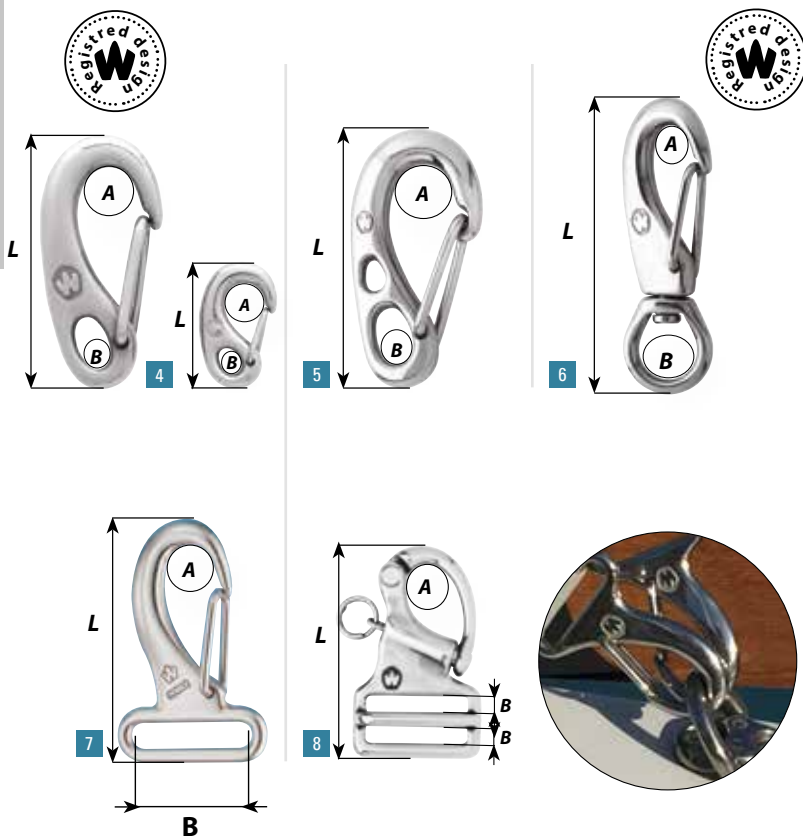

| N° | Réf | Long mm | A mm | B mm | W.L. Kg | B.L. Kg | Weight Kg |
|------------------------------|------|---------|------|------|---------|---------|-----------|
| SNAP HOOKS «PATENTED» | | | | | | | |
| 4 | 2448 | 25 | 4 | 3 | 55 | 110 | 0.006 |
| | 2479 | 35 | 6 | 4 | 80 | 150 | 0.010 |
| | 2480 | 50 | 8 | 6 | 200 | 300 | 0.023 |
| | 2481 | 75 | 12 | 10 | 480 | 700 | 0.067 |
| | 2482 | 100 | 16 | 13 | 1120 | 1500 | 0.186 |

| SAFETY SNAP HOOK «HR» | | | | | | | |
|--|------|-----|----|----|------|------|-------|
| <i>Models forged in 17.4 Ph (HR stainless steel)</i> | | | | | | | |
| 5 | 2381 | 75 | 12 | 10 | 880 | 1600 | 0.064 |
| | 2382 | 100 | 17 | 14 | 1680 | 4000 | 0.167 |

| SWIVEL SNAP HOOKS | | | | | | | |
|--------------------------|------|-----|----|----|-----|-----|-------|
| 6 | 2384 | 70 | 8 | 13 | 200 | 300 | 0.036 |
| | 2385 | 100 | 12 | 19 | 480 | 750 | 0.102 |

| WEBBING SNAP HOOK | | | | | | | |
|--------------------------|------|----|---|----|-----|-----|-------|
| 7 | 2284 | 60 | 8 | 30 | 200 | 300 | 0.035 |
| 8 | 2270 | 44 | 8 | 3 | 160 | 400 | 0.014 |

Carbine hook

| N° | Part # | D mm | Length mm | A mm | B mm | Nautical Applications | | Industrial Applications | |
|-------------------|--------------------|------|-----------|------|------|-----------------------|---------|-------------------------|-----------|
| | | | | | | W.L. Kg | B.L. Kg | W.L.L. Kg | Weight Kg |
| SYMMETRIC | | | | | | | | | |
| 1 | 2313 | 6 | 60 | 10 | 7 | 360 | 600 | 120 | 0.030 |
| | 2315 | 8 | 80 | 13 | 11 | 880 | 1300 | 260 | 0.072 |
| | 2316 | 10 | 100 | 15 | 13 | 1200 | 2500 | 500 | 0.132 |
| | 2317 | 12 | 120 | 21 | 16 | 1360 | 3600 | 720 | 0.229 |
| ASYMMETRIC | | | | | | | | | |
| 2 | 2323 | 6 | 60 | 11 | 7 | 400 | 800 | 160 | 0.031 |
| | 2325 | 8 | 80 | 15 | 11 | 960 | 1500 | 300 | 0.073 |
| | 2326 | 10 | 100 | 18 | 13 | 1320 | 2500 | 500 | 0.136 |
| | 2327 | 12 | 120 | 24 | 16 | 1440 | 4500 | 900 | 0.234 |
| | 2328 | 12 | 170 | 30 | 20 | 1440 | 4500 | 900 | 0.336 |
| | WITHOUT EYE | | | | | | | | |
| 3 | 2333 | 6 | 60 | 10 | 8 | 360 | 600 | 120 | 0.028 |
| | 2335 | 8 | 80 | 13 | 13 | 880 | 1600 | 320 | 0.062 |
| | 2336 | 10 | 100 | 15 | 14 | 1200 | 2500 | 500 | 0.124 |
| | 2337 | 12 | 120 | 21 | 16 | 1360 | 3800 | 760 | 0.200 |

| N° | Part # | D mm | Length mm | A mm | B mm | Nautical Applications | | Industrial Applications | |
|--------------------|--------|------|-----------|------|------|-----------------------|---------|-------------------------|-----------|
| | | | | | | W.L. Kg | B.L. Kg | W.L.L. Kg | Weight Kg |
| DELTA HOOKS | | | | | | | | | |
| 4 | 2345 | 8 | 80 | 13 | 40 | 720 | 1200 | 240 | 0.075 |
| | 2346 | 10 | 100 | 16 | 50 | 1120 | 2200 | 440 | 0.140 |



Working Load (WL): for nautical applications.



Working Load Limit (WLL): for industrial applications only.
The safety factor is 5 times the breaking load.
WLL = Breaking load / 5

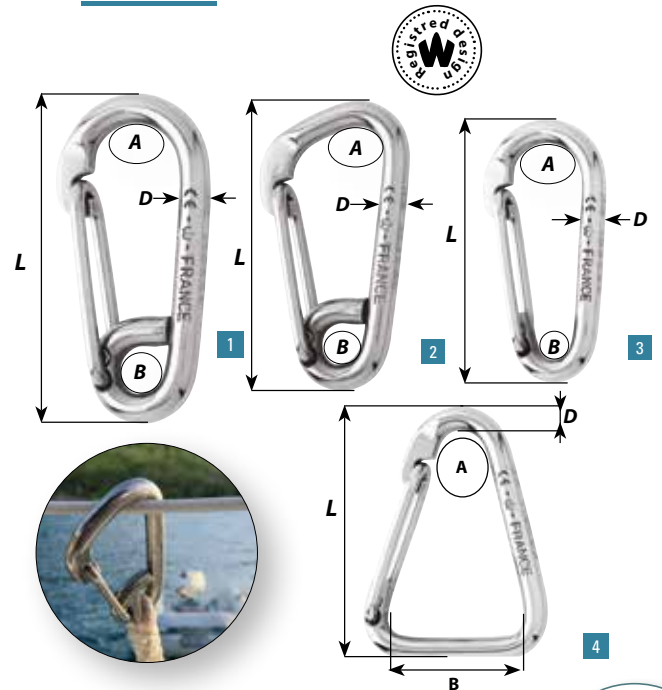

+ BENEFITS

- Designed and made in France
- Available with eye to attach strap, or without eye
- Symmetric or asymmetric shape
- Perfect for fast operations
- Standard on Wichard tethers (part # 7001, 7002, 7011)
- Wichard carabiner hooks bear the CE/WLL marking

"One hand" sail snaps

+ BENEFITS

- Ideal for setting a headsail
- One hand operation
- Available in 316L stainless steel or brass
- Efficient operation : does not jam

| N° | Part # | Material | Length mm | A mm | B mm | Nautical Applications | | Weight Kg |
|------------------------------|--------|-----------------|-----------|------|------|-----------------------|---------|-----------|
| | | | | | | W.L. Kg | B.L. Kg | |
| «ONE HAND» SAIL SNAPS | | | | | | | | |
| 4 | 2486 | stainless steel | 50 | 7,5 | 6,5 | 160 | 300 | 0.022 |
| | 2483 | stainless steel | 55 | 9 | 8 | 240 | 400 | 0.037 |
| | 2487 | stainless steel | 65 | 11 | 10 | 400 | 550 | 0.059 |
| | 2489 | stainless steel | 80 | 13 | 11,5 | 560 | 800 | 0.100 |
| | 2488 | stainless steel | 90 | 17 | 13 | 800 | 1050 | 0.143 |
| | 2490 | stainless steel | 110 | 24 | 15 | 960 | 1300 | 0.244 |
| 5 | 72486 | brass | 50 | 7,5 | 6,5 | 80 | 100 | 0.030 |
| | 72483 | brass | 55 | 9 | 8 | 120 | 180 | 0.036 |
| | 72487 | brass | 65 | 11 | 10 | 200 | 250 | 0.056 |



Mooring hooks

+ BENEFITS

- 2 models available: simple or automatic
- Can be used on most boat hooks
- Perfect for mooring buoys



| N° | Part # | Ø mm | Length mm | A mm | B mm | Weight Kg |
|----|--------|------|-----------|------|------|-----------|
|----|--------|------|-----------|------|------|-----------|

| SIMPLE MOORING HOOKS (incl spare attachment fitting) | | | | | | |
|--|-------|----|-----|----|----|-------|
| 1 | 92326 | 10 | 100 | 18 | 13 | 0.176 |
| | 92327 | 12 | 120 | 24 | 16 | 0.280 |
| | 92328 | 12 | 170 | 30 | 20 | 0.378 |

| SPARE ATTACHMENT FITTING FOR MOORING HOOKS | | | | | | |
|--|-------|--|--|--|--|--|
| 2 | 72326 | For part # 92326 - Weight: 0.025 Kg | | | | |
| | 72327 | For parts # 92327 and 92328 - Weight: 0.035 Kg | | | | |

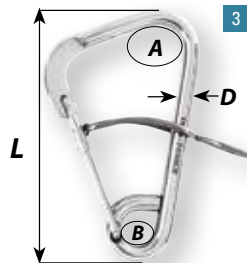

| N° | Part # | D mm | Length mm | A mm | B mm | Weight Kg |
|----|--------|------|-----------|------|------|-----------|
|----|--------|------|-----------|------|------|-----------|

| AUTOMATIC MOORING HOOKS | | | | | | |
|-------------------------|------|-----------|----|-----|----|-------|
| 3 | 2329 | Automatic | 12 | 170 | 30 | 0,380 |



Chain grip

| N° | Part # | Length mm | A mm | W.L. Kg | Weight Kg |
|----|--------|-----------|------|---------|-----------|
|----|--------|-----------|------|---------|-----------|

| CHAIN GRIP | | | | | | |
|------------|------|-----------------|-----|----|-----|-------|
| 4 | 2994 | For 8 mm chain | 85 | 17 | 480 | 0.088 |
| | 2995 | For 10 mm chain | 103 | 22 | 720 | 0.156 |
| | 2996 | For 12 mm chain | 125 | 24 | 960 | 0.287 |

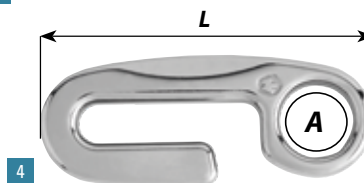

+ BENEFITS

- Complete chain grip kit
- Ready to use
- No splicing knowledge required
- 1 stainless steel chain grip
- 1 pre-spliced twisted 3 strand polyester
- Available for the 3 Wichard chain grip models
- Wear indicator
- Color: black / blue
- Applications: mooring
- Suitable for sailing and motor boats



| N° | Part # | Chain grip part# | Rope length m |
|----|--------|------------------|---------------|
|----|--------|------------------|---------------|

| CHAIN GRIP KIT | | | | |
|----------------|-------|------------------------|------|---|
| 5 | 29944 | Rope 12 mm - Length 4m | 2994 | 4 |
| | 29955 | Rope 12 mm - Length 5m | 2995 | 5 |
| | 29966 | Rope 16 mm - Length 6m | 2996 | 6 |



Rings and adjusters

Wichard stainless steel rings and adjusters are hot drop forged from 316L stainless steel in a single piece, not just bent and welded. Forging is a far superior process, because it maintains the structural integrity of the metal and increases working load limits in real world applications. Each part is polished and passivated to create a beautiful, yet durable surface that is highly resistant to corrosion. The "W" pentagon (plus 316L) mark stamped into each part is your Wichard quality assurance.



| Part # | N° | Description | A mm | B mm | C mm | D mm | E mm | F mm | G mm | B.L Kg | Weight Kg |
|------------------|----|-------------------|------|------|------|------|------|------|------|--------|-----------|
| RING | | | | | | | | | | | |
| 6782 | 1 | Ring | 5 | - | 21.5 | - | 31.5 | - | - | 2000 | 0.014 |
| 6783 | | Ring | 5 | - | 33 | - | 43 | - | - | 2000 | 0.018 |
| 6784 | | Ring | 7.3 | - | 45 | - | 59.6 | - | - | 4000 | 0.057 |
| 6711 | 2 | D Ring | 6 | - | 40.4 | 21 | 33 | 52.4 | - | 3000 | 0.029 |
| 6712 | | D Ring | 6 | - | 50.2 | 26.4 | 38.5 | 62.2 | - | 3000 | 0.035 |
| 6721 | 3 | D Ring | 5 | - | 30 | 25 | 35 | 40 | - | 2000 | 0.019 |
| 16504 | 4 | «HR» D Ring | 6 | - | 28 | 17 | 29 | 45.5 | - | 2700 | 0.026 |
| 16505 | | «HR» D Ring | 7.3 | - | 36.5 | 22 | 37.5 | 59 | - | 4500 | 0.058 |
| 16506 | | «HR» D Ring | 10 | - | 46.9 | 28.5 | 47.4 | 75.3 | - | 9000 | 0.120 |
| ADJUSTERS | | | | | | | | | | | |
| 6731 | 5 | Triangle | 4.4 | 18.2 | 30 | 20.6 | 28.6 | 38 | - | 1200 | 0.010 |
| 6732 | | Triangle | 6 | 28.2 | 50 | 32.5 | 45 | 63 | - | 3000 | 0.037 |
| 6751 | 6 | Triangle with bar | 6.3 | 24.5 | 45 | 26 | 10 | 57.6 | 54.9 | 3000 | 0.058 |
| 6771 | 7 | Double adjuster | 4 | - | 41.5 | 5 | 7 | 58 | 38 | 1200 | 0.051 |
| 6772 | 8 | Double adjuster | 5-8 | - | 44.7 | 13.8 | 14.7 | 60 | 47.8 | 3000 | 0.078 |

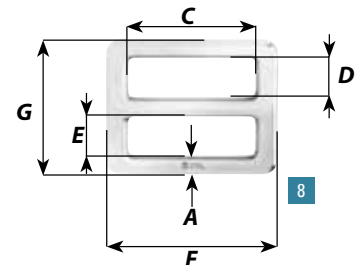
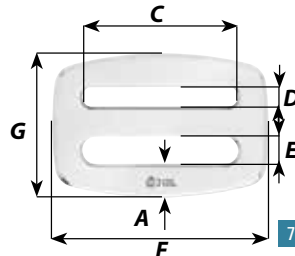
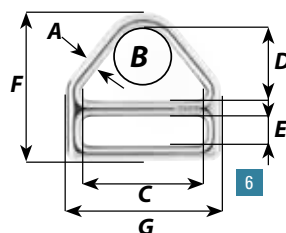
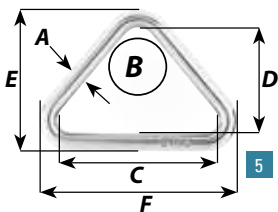
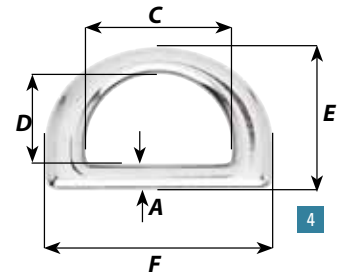
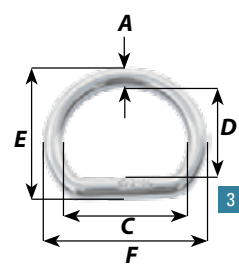
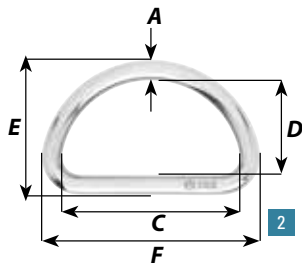
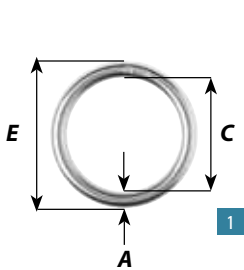



Swivels



The Wichard swivels are used to link two parts which may have different rotation directions. Wichard offers a complete range of swivels forged either with HR stainless steel or grade 316L stainless steel.

Wichard offers a complete range of swivels:

- With clevis pin or pin with allen head.
- With large bail.
- For webbing applications.
- For mooring applications.

Swivels

Swivels « HR »

+ BENEFITS

- Full range of products
- Forged in 17.4 Ph HR stainless steel
- Outstanding working and breaking loads
- Ball bearing models available
- Multi-use on board
- HR swivels are not recommended for use underwater

| N° | Part # | Length mm | A mm | B mm | C mm | Ø D mm | W.L. Kg | B.L. Kg | Weight Kg |
|----|--------|-----------|------|------|------|--------|---------|---------|-----------|
|----|--------|-----------|------|------|------|--------|---------|---------|-----------|

WITH CLEVIS PIN

| | | | | | | | | | |
|---|-------|-----|-------------------------|----|----|----|------|------|-------|
| 1 | 2464 | 70 | 14 | 21 | 11 | 7 | 1600 | 2800 | 0.087 |
| | 82464 | 70 | same with ball bearings | | | | 1600 | 2800 | 0.087 |
| | 2465 | 105 | 19 | 31 | 18 | 11 | 3200 | 6000 | 0.280 |
| | 82465 | 105 | same with ball bearings | | | | 3200 | 6000 | 0.280 |

PIN WITH ALLEN HEAD

| | | | | | | | | | |
|---|------|-----|----|----|----|----|------|------|-------|
| 2 | 2364 | 70 | 14 | 21 | 11 | 8 | 1440 | 2800 | 0.084 |
| | 2365 | 105 | 19 | 31 | 18 | 10 | 3200 | 5500 | 0.265 |

LARGE BAIL

| | | | | | | | | | |
|---|-------|-----|-------------------------|----|--|--|------|------|-------|
| 3 | 2467 | 80 | 26 | 14 | | | 1600 | 3000 | 0.096 |
| | 82467 | 80 | same with ball bearings | | | | 1600 | 3000 | 0.096 |
| | 2468 | 115 | 35 | 19 | | | 3200 | 6500 | 0.263 |
| | 82468 | 115 | same with ball bearings | | | | 3200 | 6500 | 0.268 |
| | 2466 | 125 | 41 | 21 | | | 5200 | 8500 | 0.368 |

WEBBING SWIVEL

| | | | | | | | | | |
|---|------|----|----|----|--|--|------|------|-------|
| 4 | 2367 | 60 | 11 | 30 | | | 960 | 1500 | 0.056 |
| | 2368 | 80 | 14 | 40 | | | 1600 | 3200 | 0.107 |

Fork - FORK (SS CAMBERED PLATE)

| | | | | | | | | | |
|---|-------|----|----|----|----|---|-----|------|-------|
| 5 | 2461* | 45 | 9 | 10 | 10 | 5 | 480 | 1000 | 0.026 |
| | 2462* | 60 | 15 | 13 | 12 | 6 | 720 | 1400 | 0.052 |

* Parts # 2461 and 2462 are not "HR".

TRADUCTION

| | | | | | | | | | |
|---|------|-----|----|----|----|----|------|------|-------|
| 6 | 2463 | 80 | 20 | 17 | 11 | 8 | 1440 | 2800 | 0.102 |
| | 2469 | 120 | 30 | 27 | 18 | 10 | 2000 | 5000 | 0.322 |

ALLEN HEAD PIN

| | | | | | | | | | |
|---|------|-----|----|----|----|----|------|------|-------|
| 7 | 2363 | 80 | 20 | 17 | 11 | 8 | 1440 | 2800 | 0.099 |
| | 2369 | 120 | 31 | 27 | 18 | 10 | 2000 | 5000 | 0.312 |

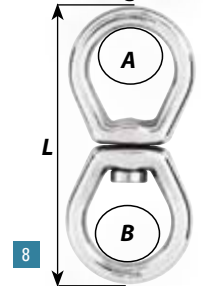
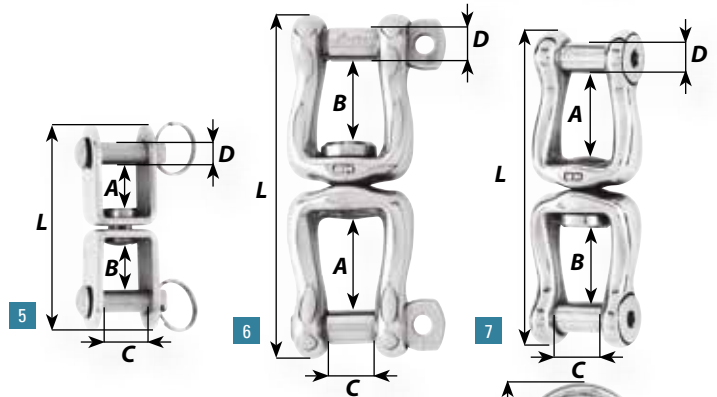
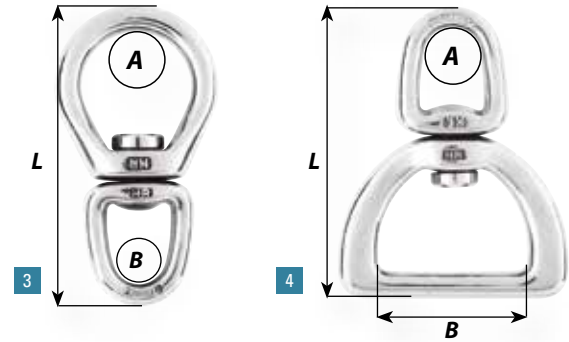
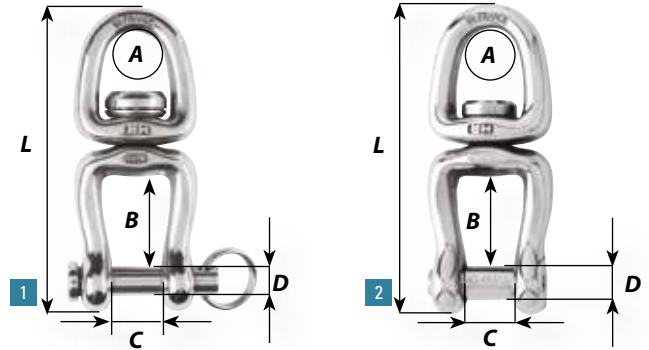

Mooring swivels

+ BENEFITS

- Forged in specific grade of stainless steel
- Designed and made in France
- Excellent corrosion resistance
- To be used with shackles # 1206, 1207, 1246, 1247 and 1248

| N° | Part # | Length mm | A mm | B mm | W.L. Kg | B.L. Kg | Weight kg |
|------------------------|--------|-----------|------|------|---------|---------|-----------|
| MOORINGS SWIVEL | | | | | | | |
| 8 | 2442 | 130 | 38 | 35 | 1760 | 4000 | 0.290 |
| | 2443 | 150 | 44 | 41 | 2960 | 5500 | 0.415 |

WL: working load - BL: breaking load



Shackles



The quality of our products, and in particular our shackles, has proven its worth in many applications and especially in extreme sports.

Why choose a Wichard shackle?

- Remarkably strong
- Optimal size and weight
- Proven resistance to corrosion
- Quality manufacturing
- A wide range of products

Accessories on page 32

A wide range of products

Wichard provides the most complete range of shackles on the market. You'll find the right Wichard shackle for your boat or other applications.

+ A WIDE CHOICE AVAILABLE:

- Rope diameter: 4 mm to 24 mm
- Breaking load: 700 kg to 35 tonnes

+ VARIOUS MATERIALS:

316L S/Steel, 17.4 PH (HR) S/Steel, Duplex S/Steel or titanium; it's your choice:

- 316L stainless steel: the right compromise between strength and resistance to corrosion.
- 17.4 PH (HR) stainless steel: for greater mechanical strength.
- Titanium (Ta6V): when weight saving is the priority

+ VARIOUS FUNCTIONS:

Self-locking pin, captive pin, quick-release pin, allen head pin... Wichard makes different versions for various applications.

+ CE MARKING:

Some of our products can be used as lifting accessories and as such bear the CE marking (awarded under the auto-certification scheme in accordance with the Machines Directive 2006/42).

Each product displays the following information

- Working Load Limit (WLL)
- CE marking, product origin, manufacturer's logo
- Materials



Captive pin shackle - no risk of losing the pin



Self-locking pin - avoids accidental release due to vibrations

+ VARIOUS SHAPES

Our shackles come in various shapes to ensure they do a proper job, in the right conditions, and last for a long, long time.

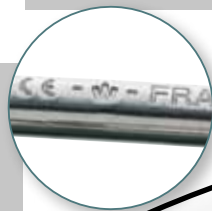

Working Load (WL): for nautical applications.



Working Load Limit (WLL): for industrial applications only.
The safety factor is 5 times the breaking load. $WLL = \text{Breaking load} / 5$

Self-locking shackles



+ BENEFITS

- Large range of self-locking shackles
- Head of shackle pin locked into one of the notches
- Avoids accidental release due to vibrations
- Available in various versions to suit many applications
- Forged in 316L stainless steel
- Designed and made in France



| N° | Part # | Dia D mm | A mm | B mm | C mm | D mm | E mm | F mm | G mm | H mm | M mm | W.L. Kg | B.L. Kg | W.L.L. Kg | Weight Kg |
|----|--------|----------|------|------|------|------|------|------|------|------|------|---------|---------|-----------|-----------|
| 1 | 1201 | 4 | 13 | 8 | 4 | 8 | 3 | 23 | 20 | - | - | 320 | 700 | 140 | 0.007 |
| | 1202 | 5 | 16 | 10 | 5 | 10 | 4 | 29 | 26 | - | - | 400 | 1000 | 200 | 0.013 |
| | 1203 | 6 | 20 | 12 | 6 | 12 | 5 | 34 | 31 | - | - | 600 | 1600 | 320 | 0.022 |
| | 1204 | 8 | 26 | 16 | 8 | 16 | 7 | 45 | 41 | - | - | 1000 | 2700 | 540 | 0.055 |
| | 1205 | 10 | 33 | 20 | 10 | 19 | 9 | 57 | 52 | - | - | 1520 | 4300 | 860 | 0.098 |
| | 1206 | 12 | 42 | 27 | 12 | 24 | 11 | 73 | 62 | - | - | 2080 | 6000 | 1200 | 0.193 |
| | 1207* | 14 | 47 | 28 | 14 | 28 | 13 | 82 | 78 | - | - | 2400 | 8000 | 1600 | 0.312 |

SELF-LOCKING LONG SHACKLES

| | | | | | | | | | | | | | | | |
|---|------|----|----|----|----|----|----|----|----|---|---|------|------|------|-------|
| 2 | 1211 | 4 | 22 | 8 | 4 | 8 | 4 | 32 | 21 | - | - | 320 | 700 | 140 | 0.08 |
| | 1212 | 5 | 29 | 10 | 5 | 10 | 4 | 41 | 26 | - | - | 400 | 1000 | 200 | 0.017 |
| | 1213 | 6 | 33 | 12 | 6 | 12 | 5 | 47 | 31 | - | - | 600 | 1600 | 320 | 0.027 |
| | 1214 | 8 | 45 | 16 | 8 | 16 | 7 | 64 | 41 | - | - | 1000 | 2700 | 540 | 0.066 |
| | 1215 | 10 | 55 | 20 | 10 | 19 | 9 | 79 | 52 | - | - | 1520 | 4300 | 860 | 0.128 |
| | 1216 | 12 | 66 | 26 | 12 | 24 | 11 | 98 | 62 | - | - | 2080 | 6000 | 1200 | 0.240 |

SELF-LOCKING TWISTED SHACKLE

| | | | | | | | | | | | | | | | |
|---|------|----|----|----|----|----|---|----|----|---|---|------|------|---|-------|
| 3 | 1222 | 5 | 26 | 10 | 5 | 10 | 4 | 38 | 26 | - | - | 480 | 1100 | - | 0.016 |
| | 1223 | 6 | 30 | 12 | 6 | 12 | 5 | 45 | 31 | - | - | 600 | 1500 | - | 0.027 |
| | 1224 | 8 | 40 | 16 | 8 | 16 | 7 | 60 | 41 | - | - | 1000 | 3000 | - | 0.067 |
| | 1225 | 10 | 50 | 20 | 10 | 19 | 9 | 74 | 52 | - | - | 1440 | 4500 | - | 0.127 |

SELF-LOCKING BOW SHACKLES

| | | | | | | | | | | | | | | | |
|---|-------|----|----|----|----|----|----|-----|-----|------|-----|------|-------|------|-------|
| 4 | 1241 | 4 | 18 | 8 | 4 | 8 | 3 | 28 | 20 | 13 | 21 | 320 | 700 | 140 | 0.009 |
| | 1242 | 5 | 23 | 10 | 5 | 10 | 4 | 35 | 25 | 16 | 25 | 400 | 1000 | 200 | 0.017 |
| | 1243 | 6 | 28 | 12 | 6 | 12 | 5 | 43 | 33 | 19.5 | 32 | 600 | 1500 | 300 | 0.030 |
| | 1244 | 8 | 37 | 16 | 8 | 16 | 7 | 56 | 41 | 25.5 | 39 | 1000 | 2700 | 540 | 0.068 |
| | 1245 | 10 | 47 | 20 | 10 | 20 | 9 | 71 | 52 | 32 | 52 | 1520 | 4300 | 860 | 0.137 |
| | 1246 | 12 | 55 | 27 | 12 | 24 | 10 | 87 | 61 | 38.5 | 63 | 2080 | 6000 | 1200 | 0.233 |
| | 1247* | 16 | 70 | 32 | 16 | 32 | 15 | 112 | 88 | 51 | 85 | 3200 | 10000 | 2000 | 0.540 |
| | 1248* | 20 | 80 | 40 | 20 | 40 | 18 | 135 | 108 | 60 | 100 | 4500 | 15000 | 3000 | 1.056 |

SELF-LOCKING LARGE OPENING SHACKLE

| | | | | | | | | | | | | | | | |
|---|------|----|----|------|----|----|----|----|----|---|---|------|------|-----|-------|
| 5 | 1262 | 5 | 36 | 20 | 5 | 11 | 5 | 48 | 35 | - | - | 330 | 1100 | 220 | 0.016 |
| | 1263 | 6 | 42 | 25.5 | 6 | 14 | 6 | 58 | 44 | - | - | 450 | 1500 | 300 | 0.027 |
| | 1264 | 8 | 57 | 32 | 8 | 17 | 8 | 77 | 57 | - | - | 810 | 2700 | 540 | 0.067 |
| | 1265 | 10 | 72 | 40 | 10 | 21 | 10 | 99 | 71 | - | - | 1280 | 4000 | 800 | 0.127 |

ALLEN HEAD PIN SHACKLES «D»

The head of the pin does not stick out from the shackle's body, thus eliminating any risk of snagging.

| | | | | | | | | | | | | | | | |
|---|------|----|----|------|----|----|----|----|----|---|---|------|------|------|-------|
| 6 | 1303 | 6 | 19 | 12 | 6 | 12 | 5 | 34 | 25 | - | - | 600 | 1600 | 320 | 0.022 |
| | 1304 | 8 | 26 | 16 | 8 | 16 | 7 | 46 | 33 | - | - | 960 | 2700 | 540 | 0.053 |
| | 1305 | 10 | 33 | 20 | 10 | 19 | 9 | 57 | 41 | - | - | 1440 | 4300 | 860 | 0.099 |
| | 1306 | 12 | 39 | 24 | 12 | 24 | 10 | 73 | 49 | - | - | 2080 | 6000 | 1200 | 0.187 |
| | 1363 | 6 | 42 | 25.5 | 6 | 14 | 6 | 58 | 38 | - | - | 450 | 1500 | 300 | 0.044 |

(specially designed for batten cars)

ALLEN HEAD PIN LONG SHACKLES

| | | | | | | | | | | | | | | | |
|---|------|---|----|----|---|---|---|---|---|---|---|------|------|---|-------|
| 7 | 1313 | 6 | 33 | 12 | - | - | - | - | - | - | - | 600 | 1600 | - | 0.027 |
| | 1314 | 8 | 45 | 16 | - | - | - | - | - | - | - | 1000 | 2700 | - | 0.066 |

ALLEN HEAD PIN SHACKLES «BOW»

The head of the pin does not stick out from the shackle's body, thus eliminating any risk of snagging.

| | | | | | | | | | | | | | | | |
|---|------|----|----|------|----|----|----|----|----|---|----|------|------|------|-------|
| 8 | 1343 | 6 | 27 | 12 | 6 | 12 | 5 | 42 | 24 | - | 32 | 600 | 1500 | 300 | 0.029 |
| | 1344 | 8 | 37 | 16 | 8 | 16 | 7 | 56 | 32 | - | 40 | 960 | 2700 | 540 | 0.067 |
| | 1345 | 10 | 47 | 20 | 10 | 20 | 9 | 72 | 40 | - | 52 | 1440 | 4300 | 860 | 0.133 |
| | 1346 | 12 | 55 | 27.2 | 12 | 24 | 10 | 87 | 50 | - | 63 | 2080 | 6000 | 1200 | 0.222 |

TACK SHACKLES

These shackles are specially designed for adjustment to the width of goosenecks.

| | | | | | | | | | | | | | | | |
|---|------|---|----|----|---|----|---|----|----|---|---|-----|------|---|-------|
| 9 | 1233 | 6 | 45 | 16 | 6 | 13 | 4 | 60 | 33 | - | - | 520 | 1500 | - | 0.048 |
| | 1234 | 8 | 59 | 21 | 8 | 17 | 6 | 79 | 45 | - | - | 800 | 2300 | - | 0.110 |

WL: working load - BL: breaking load

* Parts # 1247, 1248 and 1207 are not self-locking shackles.

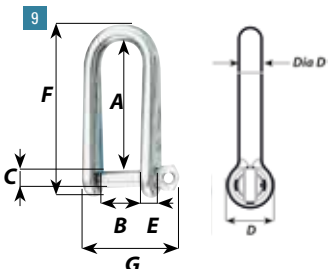
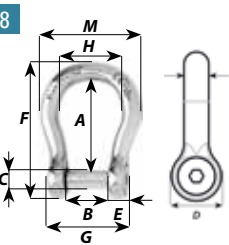
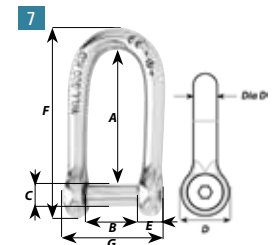
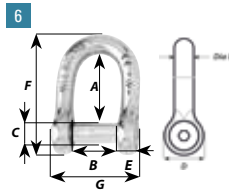
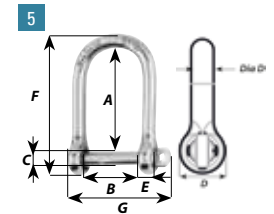
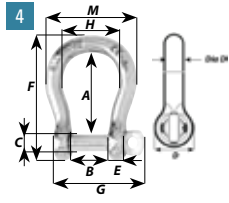
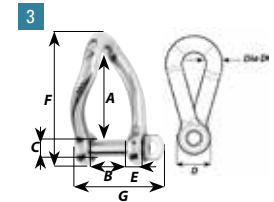
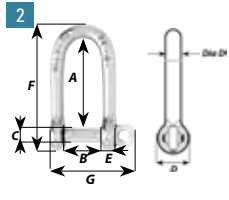
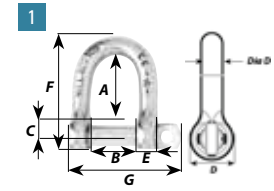

Captive pin shackles

| N° | Part # | Dia d mm | A mm | B mm | C mm | D mm | E mm | F mm | G mm | H mm | M mm | W.L. Kg | B.L. Kg | W.L.L. Kg | Weight Kg |
|---------------------------------|--------|----------|-------|------|------|------|------|------|------|------|------|---------|---------|-----------|-----------|
| CAPTIVE PIN «D» SHACKLES | | | | | | | | | | | | | | | |
| 1 | 1401 | 4 | 13 | 8 | 5 | 9 | 4 | 24 | 22 | - | - | 320 | 1000 | 200 | 0.009 |
| | 1402 | 5 | 16.50 | 10 | 6 | 11 | 5 | 30 | 30 | - | - | 480 | 1500 | 300 | 0.016 |
| | 1403 | 6 | 20 | 12 | 7 | 14 | 6 | 36 | 32 | - | - | 680 | 2200 | 440 | 0.028 |
| | 1404 | 8 | 26 | 16 | 9 | 18 | 8 | 47 | 42 | - | - | 1080 | 3600 | 720 | 0.061 |
| | 1405 | 10 | 33 | 20 | 11 | 21 | 9 | 58 | 53 | - | - | 1560 | 5200 | 1040 | 0.114 |
| | 1406 | 12 | 39 | 24 | 13 | 24 | 11 | 69 | 62 | - | - | 2100 | 7000 | 1400 | 0.188 |

| N° | Part # | Dia d mm | A mm | B mm | C mm | D mm | E mm | F mm | G mm | H mm | M mm | W.L. Kg | B.L. Kg | W.L.L. Kg | Weight Kg |
|----------------------------------|--------|----------|------|------|------|------|------|------|------|------|------|---------|---------|-----------|-----------|
| CAPTIVE LONG «D» SHACKLES | | | | | | | | | | | | | | | |
| 2 | 1411 | 4 | 31 | 8 | 5 | 9 | 4 | 41 | 22 | | | 320 | 1000 | 200 | 0.012 |
| | 1412 | 5 | 39 | 10 | 6 | 11 | 5 | 52 | 27 | | | 480 | 1500 | 300 | 0.024 |
| | 1413 | 6 | 46 | 12 | 7 | 14 | 6 | 63 | 32 | | | 680 | 2200 | 440 | 0.040 |
| | 1414 | 8 | 62 | 16 | 9 | 17 | 8 | 82 | 43 | | | 1080 | 3600 | 720 | 0.092 |
| | 1415 | 10 | 78 | 20 | 11 | 21 | 10 | 103 | 54 | | | 1560 | 5200 | 1040 | 0.176 |
| | 1416 | 12 | 90 | 24 | 13 | 24 | 11 | 123 | 62 | | | 2100 | 7000 | 1400 | 0.284 |

| N° | Part # | Dia d mm | A mm | B mm | C mm | D mm | E mm | F mm | G mm | H mm | M mm | W.L. Kg | B.L. Kg | W.L.L. Kg | Weight Kg |
|---------------------------------|--------|----------|------|------|------|------|------|------|------|------|------|---------|---------|-----------|-----------|
| CAPTIVE TWISTED SHACKLES | | | | | | | | | | | | | | | |
| 3 | 1422 | 5 | 37 | 10 | 6 | 11 | 5 | 50 | 27 | | | 480 | 1100 | - | 0.023 |
| | 1423 | 6 | 44 | 12 | 7 | 14 | 6 | 60 | 31 | | | 600 | 1500 | - | 0.039 |
| | 1424 | 8 | 59 | 16 | 9 | 18 | 8 | 80 | 42 | | | 1000 | 3000 | - | 0.090 |
| | 1425 | 10 | 74 | 20 | 11 | 21 | 9 | 99 | 53 | | | 1520 | 4500 | - | 0.170 |

| N° | Part # | Dia d mm | A mm | B mm | C mm | D mm | E mm | F mm | G mm | H mm | M mm | W.L. Kg | B.L. Kg | W.L.L. Kg | Weight Kg |
|---------------------------------|--------|----------|------|------|------|------|------|------|------|------|------|---------|---------|-----------|-----------|
| CAPTIVE PIN BOW SHACKLES | | | | | | | | | | | | | | | |
| 4 | 1441 | 4 | 18 | 8 | 5 | 9 | 4 | 28 | 20 | 13 | 21 | 320 | 1000 | 200 | 0.010 |
| | 1442 | 5 | 23 | 10 | 6 | 11 | 5 | 35 | 25 | 16 | 26 | 480 | 1500 | 300 | 0.019 |
| | 1443 | 6 | 27 | 12 | 7 | 14 | 6 | 43 | 31 | 19 | 31 | 660 | 2200 | 440 | 0.033 |
| | 1444 | 8 | 37 | 16 | 9 | 18 | 8 | 56 | 41 | 25 | 42 | 1110 | 3700 | 740 | 0.075 |
| | 1445 | 10 | 46 | 20 | 11 | 21 | 9 | 72 | 52 | 31 | 52 | 1560 | 5200 | 1040 | 0.139 |

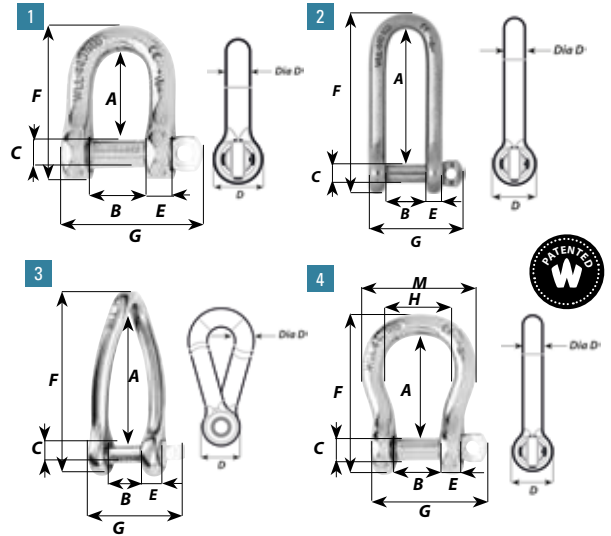

+ BENEFITS

- Self-locking pin cannot be dropped when opened
- No risk of losing the pin
- Wide range to meet all needs
- Forged in 316L stainless steel
- Designed and made in France

Key pin shackles

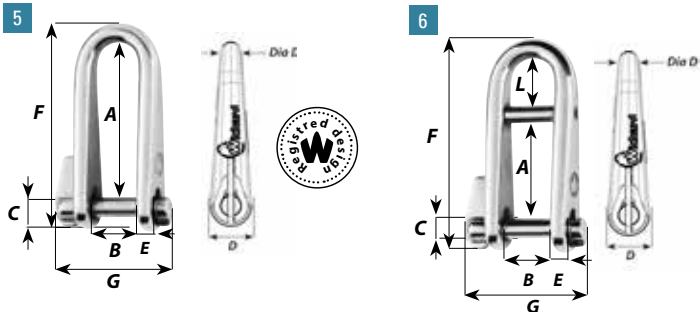

+ BENEFITS

- Patented design
- Opening by half turn
- Easy to install with one hand
- Forged in 316L stainless steel
- Designed and made in France

| N° | Part # | Dia d mm | A mm | B mm | C mm | D mm | E mm | F mm | G mm | L mm | W.L. Kg | B.L. Kg | Weight Kg |
|-------------------------|--------|----------|------|------|------|------|------|------|------|------|---------|---------|-----------|
| KEY PIN SHACKLES | | | | | | | | | | | | | |
| 5 | 1432 | 5 | 37 | 13 | 5 | 11 | 4 | 49 | 31 | - | 400 | 1000 | 0.031 |
| | 1433 | 6 | 45 | 16 | 6 | 13 | 4 | 60 | 37 | - | 520 | 1500 | 0.048 |
| | 1434 | 8 | 59 | 21 | 8 | 17 | 6 | 79 | 49 | - | 800 | 2300 | 0.121 |

| N° | Part # | Dia d mm | A mm | B mm | C mm | D mm | E mm | F mm | G mm | L mm | W.L. Kg | B.L. Kg | Weight Kg |
|----------------------------------|--------|----------|------|------|------|------|------|------|------|------|---------|---------|-----------|
| KEY PIN SHACKLES WITH BAR | | | | | | | | | | | | | |
| 6 | 81432 | 5 | 37 | 13 | 5 | 11 | 4 | 49 | 31 | 12 | 400 | 1200 | 0.031 |
| | 81433 | 6 | 45 | 16 | 6 | 13 | 4 | 60 | 37 | 15 | 520 | 1700 | 0.052 |
| | 81434 | 8 | 59 | 21 | 8 | 17 | 6 | 79 | 49 | 20 | 800 | 2500 | 0.123 |

WL: working load - BL: breaking load

Thimble shackles

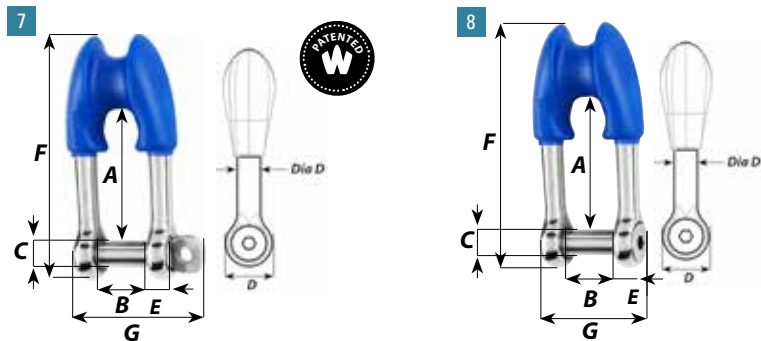

+ BENEFITS

- Forged in 316L stainless steel
- Allows splicing on head of shackle
- No additional stainless steel cringles
- Designed and made in France

| N° | Part # | Dia d mm | A mm | B mm | C mm | D mm | E mm | F mm | G mm | Ø rope max. mm | W.L. Kg | B.L. Kg | Weight Kg |
|--|--------|----------|------|------|------|------|------|------|------|----------------|---------|---------|-----------|
| THIMBLES SHACKLES WITH CAPTIVE PIN | | | | | | | | | | | | | |
| 7 | 1494 | 8 | 41 | 16 | 8 | 16 | 7 | 76 | 42 | 12 | 1000 | 3000 | 0.078 |
| | 1495 | 10 | 51 | 20 | 10 | 20 | 9 | 95 | 54 | 16 | 1520 | 5000 | 0.146 |
| THIMBLES SHACKLES WITH ALLEN HEAD PIN | | | | | | | | | | | | | |
| 8 | 1394 | 8 | 41 | 16 | 8 | 16 | 7 | 76 | 33 | 12 | 1000 | 3000 | 0.076 |
| | 1395 | 10 | 51 | 20 | 10 | 20 | 8 | 96 | 41 | 16 | 1520 | 5000 | 0.142 |

Titanium shackles

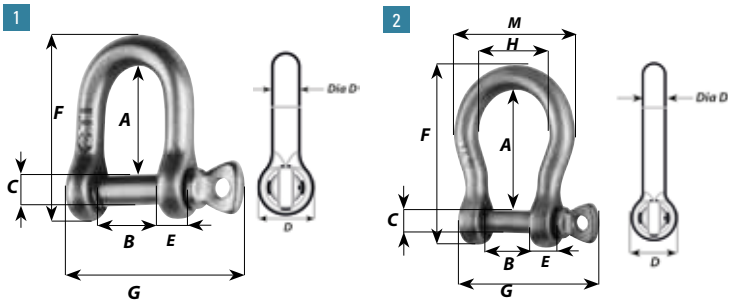

+ BENEFITS

- Forged in Titanium TA6V
- Important weight saving: 40%
- Available in D and bow models
- Designed and made in France

1 titanium shackle is up to 45% lighter than a standard 316L shackle.

| N° | Part # | Dia d mm | A mm | B mm | c mm | D mm | E mm | F mm | G mm | H mm | M mm | WL Kg | BL Kg | Weight Kg |
|------------------------------|--------|----------|------|------|------|------|------|------|------|------|------|-------|-------|-----------|
| TITANIUM SHACKLES | | | | | | | | | | | | | | |
| 1 | 51203 | 6 | 20 | 12 | 6 | 12 | 5 | 35 | 35 | - | - | 880 | 1700 | 0.014 |
| | 51204 | 8 | 26 | 16 | 8 | 16 | 7 | 47 | 46 | - | - | 1440 | 3000 | 0.034 |
| TITANIUM BOW SHACKLES | | | | | | | | | | | | | | |
| 2 | 51245 | 10 | 47 | 20 | 10 | 20 | 9 | 72 | 58 | 32 | 52 | 2160 | 6000 | 0.082 |
| | 51246 | 12 | 55 | 27 | 12 | 24 | 10 | 86 | 68 | 38 | 63 | 2800 | 8000 | 0.136 |

HR shackles

+ BENEFITS

- Forged in HR (High resistance) stainless steel
- Outstanding working loads
- Available in D, long, bow and key pin models
- Designed and made in France

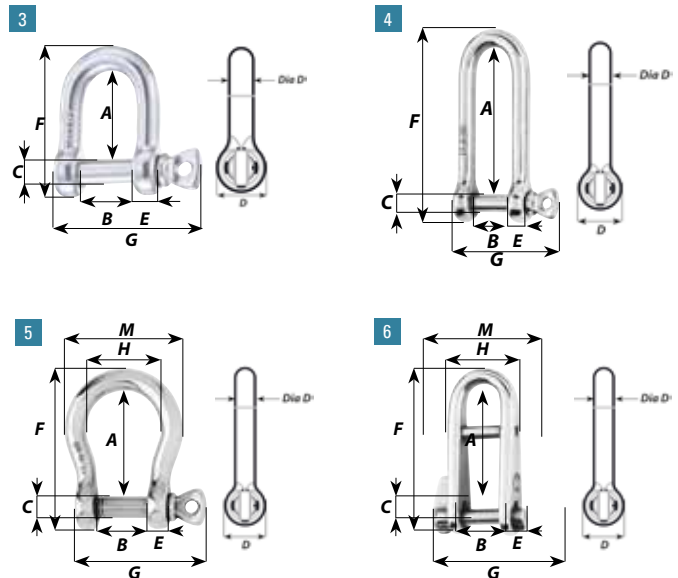

| N° | Part # | Dia d mm | A mm | B mm | C mm | D mm | E mm | F mm | G mm | H mm | M mm | WL Kg | BL Kg | W.L.L Kg | Weight Kg |
|-------------------------------------|--------|----------|------|------|------|------|------|------|------|------|------|-------|-------|----------|-----------|
| HR «D» SHACKLES | | | | | | | | | | | | | | | |
| 3 | 11203 | 6 | 20 | 12 | 6 | 16 | 7 | 46 | 46 | - | - | 1040 | 2300 | 460 | 0.024 |
| | 11204 | 8 | 26 | 16 | 8 | 16 | 7 | 46 | 46 | - | - | 1760 | 4100 | 820 | 0.052 |
| | 11205 | 10 | 33 | 20 | 10 | 20 | 9 | 60 | 58 | | | 2640 | 6000 | 1200 | 0.102 |
| | 11206 | 12 | 39 | 24 | 12 | 24 | 13 | 72 | 68 | | | 3600 | 10000 | 2000 | 0.192 |
| | 11207 | 14 | 49 | 28 | 14 | 28 | 14 | 84 | 78 | | | 5120 | 12000 | 2400 | 0.304 |
| | 11208 | 16 | 56 | 32 | 16 | 32 | 16 | 96 | 87 | | | 6800 | 19000 | 3800 | 0.464 |
| | 11209 | 20 | 70 | 40 | 20 | 40 | 20 | 120 | 108 | | | 8800 | 28000 | 5600 | 0.860 |
| HR LONG SHACKLES | | | | | | | | | | | | | | | |
| 4 | 11215 | 10 | 78 | 20 | 10 | 20 | 9 | 80 | 58 | | | 2640 | 6000 | 1200 | 0.164 |
| HR BOW SHACKLES | | | | | | | | | | | | | | | |
| 5 | 11244 | 8 | 37 | 16 | 8 | 16 | 7 | 57 | 46 | 26 | 42 | 1760 | 4100 | 820 | 0.068 |
| | 11245 | 10 | 47 | 20 | 10 | 20 | 9 | 72 | 58 | 32 | 52 | 2640 | 6000 | 1200 | 0.136 |
| | 11246 | 12 | 55 | 24 | 12 | 24 | 10 | 86 | 68 | 38 | 63 | 3600 | 10000 | 2000 | 0.224 |
| | 11240 | 14 | 63 | 28 | 14 | 28 | 13 | 98 | 78 | 44 | 72 | 5120 | 12000 | 2400 | 0.364 |
| | 11247 | 16 | 70 | 32 | 16 | 32 | 15 | 113 | 87 | 50 | 83 | 6800 | 19000 | 3800 | 0.526 |
| | 11248 | 20 | 80 | 40 | 20 | 40 | 18 | 134 | 108 | 60 | 100 | 8800 | 28000 | 5600 | 1.011 |
| | 11249 | 24 | 108 | 48 | 24 | 47 | 20 | 168 | 131 | 70 | 118 | 12800 | 35000 | 7000 | 1.706 |
| HR KEY PIN SHACKLES WITH BAR | | | | | | | | | | | | | | | |
| 6 | 91432 | 5 | 37 | 13 | 5 | 11 | 4 | 49 | 31 | 12 | 480 | 1500 | 0.031 | | |
| | 91433 | 6 | 45 | 16 | 6 | 13 | 4 | 60 | 37 | 15 | 600 | 2200 | 0.053 | | |
| | 91434 | 8 | 59 | 21 | 8 | 17 | 6 | 79 | 48 | 20 | 960 | 3500 | 0.123 | | |



Working Load (WL): for nautical applications.



Working Load Limit (WLL): for industrial applications only. The safety factor is 5 times the breaking load. WLL = Breaking load / 5

1 shackle forged in HR 17.4 Ph stainless steel can be up to 60% more resistant than a shackle in 316L stainless steel.

Softlink: soft shackle

The soft shackle for all!

+ BENEFITS

- No knowledge of ropework required
- Replaces shackles and snap hooks
- Easy to fit and easy to open
- Remarkably light and strong
- Re-usable
- 3 sizes available
- Materials: stainless steel and Dyneema® SK 78

For the same strength, SoftLink is 4 or 5 times lighter than a 316L stainless steel shackle.

| N° | Part # | W.L Kg | B.L. Kg | Ø loop mm | Loop Lenght mm | Weight Kg |
|------------------------------------|--------|-----------|------------|--------------|-------------------|--------------|
| SOFTLINK 3.0 - SOFT SHACKLE | | | | | | |
| 1 | 21223 | 1500 | 2000 | 3 | 70 | 0.012 |
| SOFTLINK 4.0 - SOFT SHACKLE | | | | | | |
| 2 | 21224 | 2300 | 3000 | 4 | 80 | 0.023 |
| SOFTLINK 5.0 - SOFT SHACKLE | | | | | | |
| 3 | 21225 | 3800 | 5000 | 5 | 90 | 0.047 |



Visit our **Wichard Sailing** You Tube channel and download the **Softlink** video



Accessories

| N° | Part # | Description | Weight kg |
|------------------|--------|-----------------------------------|--------------|
| KEY RINGS | | | |
| 1 | 9304 | Key ring with pin shackle # 1441 | 0.017 |
| 2 | 9305 | Key ring with snap hook # 2480 | 0.029 |
| 3 | 9306 | Key ring with snap shackle # 2470 | 0.029 |
| 4 | 9307 | Key ring with block # 60019 | 0.019 |
| 2 | 9308 | Key ring with snap hook # 2479 | 0.029 |

| N° | Part # | Description | Weight kg |
|--------------------------------|--------|------------------------------------|--------------|
| SHACKLER AND SPIKE TOOL | | | |
| 5 | 10303 | Forged shackler with bottle opener | 0.033 |
| 6 | 10304 | Unique shackler / spike tool | 0.109 |



WL: working load - BL: breaking load

Maintenance

WICHINOX

Gel formula

Cleans and passivates stainless steel hardware

- Suitable for industrial applications
- Help reconstitute a passive protective film for stainless steel products
- Increases product longevity
- Easy to apply using a brush
- Use in the event of marked or deep-set corrosion (occasional use)
- Part #: 9605
- Volume: 250 ml





Blocks



Our blocks, wholly designed and manufactured in our factories, feature high-performance materials and are subjected to rigorous manufacturing and quality assurance processes. For whatever type of block, ball bearing, plain bearing, the shape of the sheave suits all modern ropes. They are also very easy to install due to the various types of fastening options.

Wichard offers a complete range of blocks:

- Rings
- Ball bearing and plain bearing blocks
- Snatch blocks
- Stainless steel blocks
- Deck accessories
- Roller blocks



Selection guide – blocks

| | Plain bearing blocks | Ball bearing blocks | Roller blocks | FRX: Rings | MXEvo: Block | MXLEvo: Soft block |
|--|----------------------|---------------------|---------------|------------|--------------|--------------------|
| | | | | | | |

LOAD TYPES

| | | | | | | |
|----------------------------------|--|--|--|--|--|--|
| Dynamic operation and light load | | | | | | |
| Static operation and heavy load | | | | | | |
| Dynamic operation and heavy load | | | | | | |

EXAMPLES OF USE

| | | | | | | |
|----------------------|---|---|---|---|---|---|
| Mainsail sheet | | ✓ | ✓ | | | |
| Mainsail travelers | | | ✓ | ✓ | | |
| Spinnaker sheets | | | ✓ | ✓ | | |
| Mastfoot block | ✓ | | | ✓ | ✓ | ✓ |
| Masthead block | ✓ | | | | | |
| Boom vang | ✓ | | | | ✓ | ✓ |
| Downhaul | ✓ | | | | ✓ | |
| Backstay | ✓ | | ✓ | ✓ | | |
| Mainsail foot | ✓ | | | | ✓ | ✓ |
| Reefing point | ✓ | | | | ✓ | |
| Cunningham | ✓ | | | | ✓ | |
| Barberhauler | | ✓ | | ✓ | | ✓ |
| Inhauler | | | | ✓ | | ✓ |
| Spinnaker tack point | | ✓ | ✓ | ✓ | | ✓ |

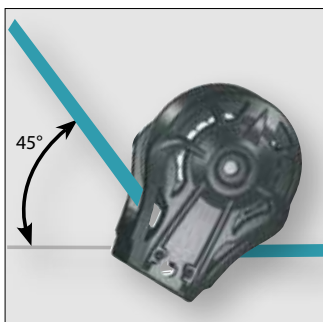

For a 45° angle: The load factor will be 75%. A load of 100 Kg on the line will represent a load of 75 Kg on the block.

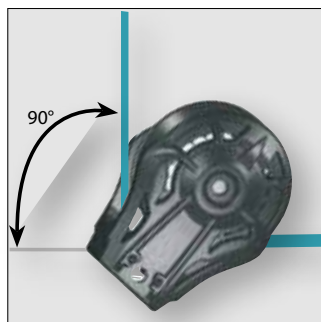

For a 90° angle: The load factor will be 140%. A load of 100 Kg on the line will represent a load of 140 Kg on the block.

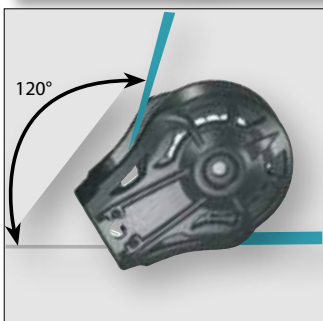

For a 120° angle: The load factor will be 180%. A load of 100 Kg on the line will represent a load of 180 Kg on the block.

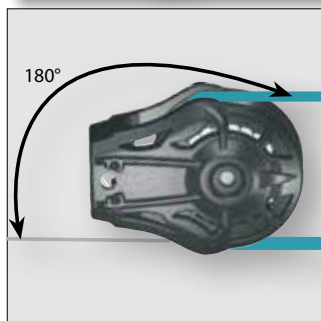

For a 180° angle: The load factor will be 200%. A load of 100 Kg on the line will represent a load of 200 Kg on the block.

| Deflection angle | Load factor |
|------------------|-------------|
| 180° | 200% |
| 160° | 197% |
| 140° | 187% |
| 120° | 180% |
| 100° | 153% |
| 90° | 140% |
| 80° | 129% |
| 60° | 100% |
| 45° | 75% |
| 20° | 35% |
| 0° | 0% |

Friction blocks

FRX : RINGS



+ BENEFITS

- 5 sizes available
- Very strong
- Very light
- Various applications: mast-foot block, inhauler, barber-hauler and more.
- Suitable for all types of rope (Dyneema®, etc.)
- Materials: hard anodized aluminium for greater lifespan

| N° | Part Block | ØA mm | ØB mm | C mm | Ø D mm | WL Kg | Weight Kg | Material |
|--------------|------------|-------|-------|------|--------|-------|-----------|-----------|
| FRX6 | | | | | | | | |
| 1 | 20705 | 5.5 | 7 | 9 | 18 | 400 | 0.002 | Aluminium |
| FRX10 | | | | | | | | |
| 2 | 21008 | 8 | 10 | 12 | 25 | 800 | 0.005 | Aluminium |
| FRX15 | | | | | | | | |
| 3 | 21510 | 10 | 15 | 15 | 35 | 1600 | 0.012 | Aluminium |
| FRX20 | | | | | | | | |
| 4 | 22014 | 14 | 20 | 21 | 47 | 3200 | 0.031 | Aluminium |
| FRX25 | | | | | | | | |
| 5 | 22517 | 17 | 25 | 25 | 60 | 5000 | 0.057 | Aluminium |

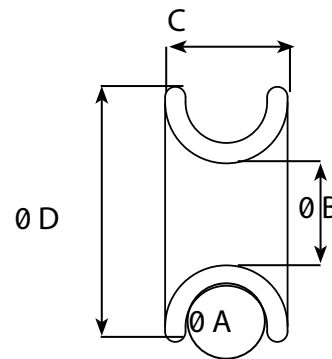

Applications
 Mast-foot block, barber-hauler, inhauler, loop, thimble, lazy jack, running backstay, tackle, and more.



Friction blocks

MXLEvo : The universal soft block solution

The MXLEvo is a soft block solution designed for all yachtsmen, whether amateur or pro. Designed for heavy load applications (mast foot, halyard tackle, barber hauler, snatch blocks, etc.), this system is available in three sizes.

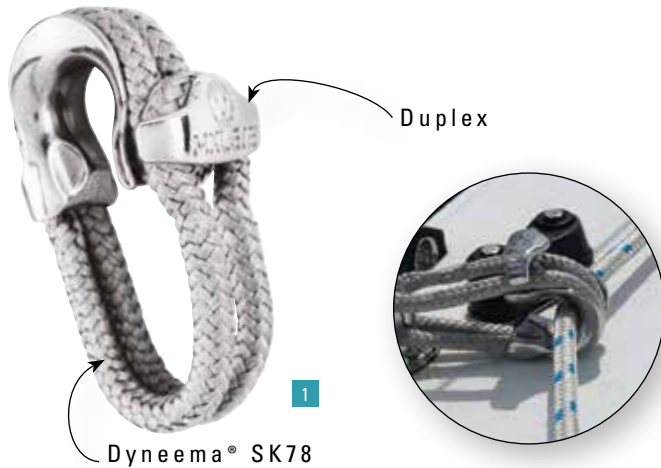

| Fig | Part # | Height mm | Width mm | Thick mm | Loop length mm | nominal Ø loop mm | W.L. Kg | B.L. Kg | Weight Kg |
|--|--------|-----------|----------|----------|----------------|-------------------|---------|---------|-----------|
| MXLEVO 10 - FOR MAX ROPE SIZE 10 MM | | | | | | | | | |
| 1 | 21104 | 30 | 40 | 26 | 170 | 4 | 800 | 2000 | 0.040 |
| MXLEVO 12 - FOR MAX ROPE SIZE 12 MM | | | | | | | | | |
| 1 | 21105 | 40 | 54 | 35 | 220 | 5 | 1600 | 3800 | 0.090 |
| MXLEVO 16 - FOR MAX ROPE SIZE 16 MM | | | | | | | | | |
| 1 | 21106 | 47 | 60 | 41 | 270 | 6 | 2500 | 5000 | 0.140 |

+ BENEFITS

- Economical and easy to use
- Designed for heavy load applications
- Lightweight, robust and highly compact
- A reliable solution and maintenance free
- Adaptable to your deck plan and anchor orientation: 2 fastening methods
- High quality materials: Duplex grade stainless steel -Dyneema® SK78
- Available in 3 sizes

MXLEvo provides exceptional resistance for its weight. In comparison with a standard competitor's block, The MXLEvo 10 is:

- > twice as robust
- > half the weight
- > a third of the size
- > For a breaking load of 5 tonnes, the MXLEvo 16 is 35% lighter.

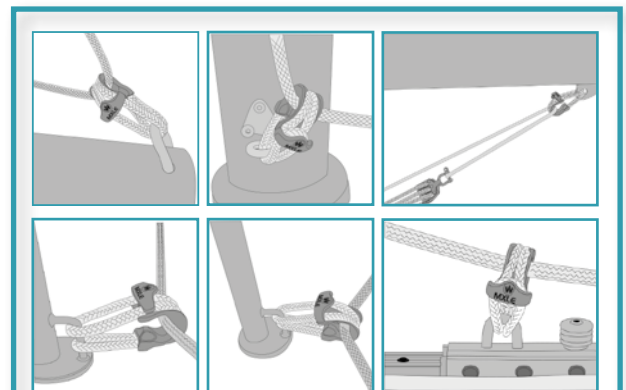

Heavy load applications:

- Mast foot block,
- Halyard tackle,
- Barber hauler,
- Block and tackle,
- Sheet return,
- Large sail foot, etc..

Friction blocks

MXEvo : Blocks

+ BENEFITS

- 2 VERSIONS AVAILABLE:
 - Captive pin version: 3 models
 - Allen head pin version: 3 models
- Perfect for taking on the heavy loads of flying sail furler terminals and 2:1 purchase mainsail halyards, mastfoot deflection
- Becket feature for purchase
- Outstanding working and breaking loads
- Optimised dimensions and weight
- Easy to install and use
- Reliable and maintenance free
- Helps to prevent excessive rope wear



MXEvo: Captive pin version

| N° | Part # Captive pin version | Length mm | Width mm | Ø mm | A mm | B mm | Ø C mm | W.L. Kg | B.L. Kg | Weight Kg |
|---|-------------------------------|-----------|----------|------|------|------|--------|---------|---------|-----------|
| MXEVO DIA 6 MM: CAPTIVE PIN - FOR MAX ROPE SIZE 8 MM | | | | | | | | | | |
| 1 | 11603 | 53 | 26 | 6 | 18 | 13 | 7 | 1040 | 2300 | 0,053 |
| MXEVO DIA 8 MM: CAPTIVE PIN - FOR MAX ROPE SIZE 10 MM | | | | | | | | | | |
| 2 | 11604 | 62 | 36 | 8 | 18 | 18 | 9 | 1760 | 4100 | 0,109 |
| MXEVO DIA 10 MM: CAPTIVE PIN - FOR MAX ROPE SIZE 14 MM | | | | | | | | | | |
| 3 | 11605 | 77 | 44 | 10 | 22 | 22 | 11 | 2640 | 6000 | 0,222 |

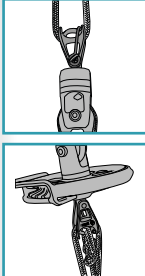

**MXEvo:
captive pin version**

This version is used for static lines:

- Flying sail furler terminal
- 2:1 mainsail halyard

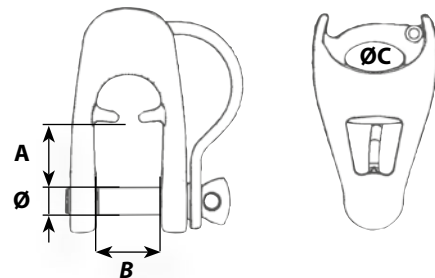

MXEvo: Allen head pin version

| N° | Part # Allen head pin version | Length mm | Width mm | Ø mm | A mm | B mm | Ø C mm | W.L. Kg | B.L. Kg | Weight Kg |
|--|----------------------------------|-----------|----------|------|------|------|--------|---------|---------|-----------|
| MXEVO DIA 6 MM: ALLEN HEAD PIN - FOR MAX ROPE SIZE 8 MM | | | | | | | | | | |
| 1 | 11613 | 53 | 26 | 6 | 18 | 13 | 7 | 720 | 1700 | 0,048 |
| MXEVO DIA 8 MM: ALLEN HEAD PIN - FOR MAX ROPE SIZE 10 MM | | | | | | | | | | |
| 2 | 11614 | 62 | 36 | 8 | 18 | 18 | 9 | 1300 | 3500 | 0,100 |
| MXEVO DIA 10 MM: ALLEN HEAD PIN - FOR MAX ROPE SIZE 14 MM | | | | | | | | | | |
| 3 | 11615 | 77 | 44 | 10 | 22 | 22 | 11 | 1760 | 5000 | 0,204 |

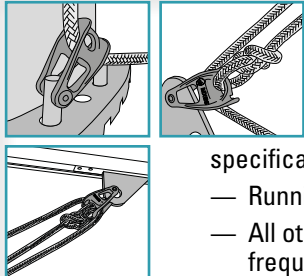

**MXEvo:
allen head pin version**

This version of the MXEvo has been specifically designed for Mast-foot fairleads,

- Running backstays
- All other applications that are not handled frequently.

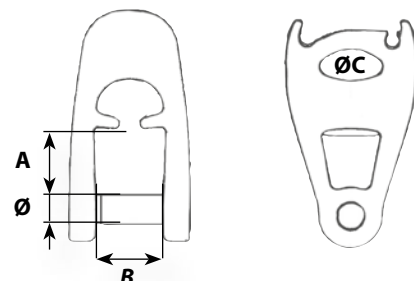

+ BENEFITS

- Large range covering all applications
- Lightness, reliability and good performance
- Wide choice of fastenings
- Perfect for dinghies and cruising yachts

| N° | Part # | Description | Height mm | Width mm | Thick. mm | W.L. Kg | B.L. Kg | Weight Kg |
|--|--------|---|-----------|----------|-----------|---------|---------|-----------|
| SHEAVE DIA 18 MM - ROPE SIZE 6 TO 8 MM | | | | | | | | |
| 1 | 30018 | Single block | 45 | 21 | 11 | 200 | 500 | 0.016 |
| 2 | 30118 | Single with becket | 57 | 31 | 11 | 200 | 500 | 0.022 |
| SHEAVE DIA 19 MM - ROPE SIZE 6 MM | | | | | | | | |
| 3 | 30019 | Single with eye | 38 | 19 | 8 | 200 | 500 | 0.012 |
| SHEAVE DIA 24 MM - ROPE SIZE 4 TO 6 MM | | | | | | | | |
| 4 | 30024 | Single with shackle | 56 | 25 | 15 | 200 | 500 | 0.021 |
| 5 | 31124 | Single block | 42 | 25 | 15 | 200 | 500 | 0.014 |
| 6 | 30124 | Single with becket and shackle | 70 | 25 | 15 | 200 | 500 | 0.026 |
| 7 | 31224 | Single with becket | 56 | 25 | 15 | 200 | 500 | 0.014 |
| 8 | 30224 | Single with V cleat, becket and shackle | 70 | 33 | 15 | 200 | 500 | 0.034 |
| 9 | 30324 | Single with V cleat and becket | 56 | 33 | 15 | 200 | 500 | 0.028 |
| 10 | 30424 | Double with shackle | 56 | 25 | 19 | 200 | 500 | 0.030 |
| 11 | 30524 | Double with becket and shackle | 70 | 25 | 19 | 200 | 500 | 0.037 |
| 12 | 30624 | Double with V cleat, becket and shackle | 70 | 33 | 19 | 200 | 500 | 0.047 |
| 13 | 30724 | Triple with shackle | 56 | 25 | 27 | 200 | 500 | 0.040 |
| 14 | 30824 | Triple with becket and shackle | 70 | 25 | 27 | 200 | 500 | 0.060 |
| 15 | 30924 | Triple with V cleat, becket and shackle | 70 | 33 | 27 | 200 | 500 | 0.060 |
| SHEAVE DIA 25 MM - ROPE SIZE 8 TO 10MM | | | | | | | | |
| 16 | 30025 | For 25 mm stanchion | 65 | 53 | 21 | 280 | 400 | 0.049 |
| 17 | 30125 | For 25 mm stanchion, pivoting | 95 | 53 | 21 | 280 | 400 | 0.070 |
| 18 | 30425 | Swivel with clevis | 59 | 25 | 21 | 200 | 300 | 0.036 |
| SWIVEL SHACKLE BLOCKS | | | | | | | | |
| 19 | 30225 | Flat 25 mm dia sheave | 50 | 50 | 32 | 240 | 600 | 0.036 |
| | 30325 | Curved 25 mm dia sheave | 50 | 50 | 40 | 240 | 600 | 0.036 |
| 20 | 30136 | Removable 36 mm dia sheave | 36 | 65 | 58 | 800 | 2000 | 0.168 |
| WIRE BLOCK WITH ALUMINIUM SHEAVE | | | | | | | | |
| 21 | 31024 | 24 mm dia sheave, for 3 mm wire | 42 | 25 | 11 | 140 | 350 | 0.019 |
| | 30036 | 36 mm dia sheave, for 4 mm wire | 66 | 39 | 11 | 200 | 500 | 0.050 |
| | 30050 | 50 mm dia sheave, for 5 mm wire | 75 | 50 | 12 | 320 | 800 | 0.084 |
| | 30070 | 70 mm dia sheave, for 7 mm wire | 105 | 70 | 17 | 1200 | 2500 | 0.222 |
| 22 | 30071 | 70 mm dia sheave, for 7 mm wire | 150 | 70 | 17 | 1200 | 1790 | 0.298 |
| SHEAVE DIA 45 MM - ROPE SIZE 10 MM | | | | | | | | |
| Mast step blocks sheave dia 45 mm | | | | | | | | |
| 23 | 30045 | Single with clevis pin | 75 | 50 | 24 | 560 | 1000 | 0.076 |
| 24 | 30145 | Swivel with clevis | 105 | 50 | 24 | 560 | 1000 | 0.104 |
| Land-yacht blocks (curved) sheave dia 50 mm | | | | | | | | |
| 25 | 31045 | Single | 85 | 50 | 24 | 320 | 800 | 0.104 |
| 26 | 31145 | Single with becket | 108 | 50 | 24 | 320 | 800 | 0.106 |

WL: working load - BL: breaking load



Blocks

plain bearing and ball bearing

SHEAVE DIA 12, 18, 25

SHEAVE DIA 12 (stainless steel sheave)

mini block - rope size 4 mm

| N° | Part plain bear. | Description | Height mm | Width mm | Thick. mm | W.L. Kg | B.L. Kg | Weight Kg |
|----|------------------|-------------|-----------|----------|-----------|---------|---------|-----------|
| 1 | 60600 | Fixed eye | 33 | 16 | 11 | 120 | 300 | 0.011 |

SHEAVE DIA 18

rope size 4 to 6 mm

| N° | Part plain bear. | Part ball bear. | Description | Height mm | Width mm | Thick. mm | W.L. Kg | B.L. Kg | Weight Kg |
|----|------------------|-----------------|-------------|-----------|----------|-----------|---------|---------|-----------|
|----|------------------|-----------------|-------------|-----------|----------|-----------|---------|---------|-----------|

SINGLE BLOCKS

| | | | | | | | | | |
|---|-------|-------|-----------------------|----|----|----|-----|-----|-------|
| 3 | 60113 | 70113 | Fixed eye | 35 | 18 | 14 | 240 | 500 | 0.011 |
| 4 | 60114 | 70114 | Fixed eye with becket | 45 | 18 | 14 | 240 | 500 | 0.015 |
| 6 | 60120 | 70120 | Cheek block | 36 | 18 | 14 | 240 | 500 | 0.010 |

DOUBLE BLOCKS

| | | | | | | | | | |
|---|-------|-------|-----------------------|----|----|----|-----|-----|-------|
| 8 | 60213 | 70213 | Fixed eye | 45 | 18 | 28 | 320 | 700 | 0.041 |
| 9 | 60214 | 70214 | Fixed eye with becket | 55 | 18 | 28 | 320 | 700 | 0.044 |

TRIPLE BLOCKS

| | | | | | | | | | |
|----|-------|-------|-----------------------|----|----|----|-----|-----|-------|
| 10 | 60313 | 70313 | Fixed eye | 45 | 18 | 42 | 480 | 900 | 0.055 |
| 11 | 60314 | 70314 | Fixed eye with becket | 55 | 18 | 42 | 480 | 900 | 0.057 |

SHEAVE DIA 25

rope size 6 to 8 mm

| N° | Part plain bear. | Part ball bear. | Description | Height mm | Width mm | Thick. mm | W.L. Kg | B.L. Kg | Weight Kg |
|----|------------------|-----------------|-------------|-----------|----------|-----------|---------|---------|-----------|
|----|------------------|-----------------|-------------|-----------|----------|-----------|---------|---------|-----------|

SINGLE BLOCKS

| | | | | | | | | | |
|---|-------|-------|-----------------------|----|----|----|-----|-----|-------|
| 2 | 61105 | 71105 | Swivel head | 64 | 25 | 18 | 200 | 500 | 0.027 |
| 3 | 61113 | 71113 | Fixed eye | 49 | 25 | 18 | 320 | 600 | 0.019 |
| 4 | 61114 | 71114 | Fixed eye with becket | 62 | 25 | 18 | 320 | 600 | 0.024 |
| 5 | 61353 | 71353 | Opposite in line | 75 | 25 | 18 | 320 | 600 | 0.037 |
| 6 | 61120 | 71120 | Cheek block | 52 | 25 | 18 | 320 | 600 | 0.021 |
| 7 | 61121 | 71121 | Upright lead block | 39 | 32 | 42 | 320 | 600 | 0.032 |

DOUBLE BLOCKS

| | | | | | | | | | |
|---|-------|-------|-----------------------|----|----|----|-----|-----|-------|
| 8 | 61213 | 71213 | Fixed eye | 64 | 25 | 34 | 400 | 800 | 0.059 |
| 9 | 61214 | 71214 | Fixed eye with becket | 78 | 25 | 34 | 400 | 800 | 0.062 |

TRIPLE BLOCKS

| | | | | | | | | | |
|----|-------|-------|-----------------------|----|----|----|-----|------|-------|
| 10 | 61313 | 71313 | Fixed eye | 60 | 25 | 51 | 480 | 1000 | 0.081 |
| 11 | 61314 | 71314 | Fixed eye with becket | 74 | 25 | 51 | 480 | 1000 | 0.087 |

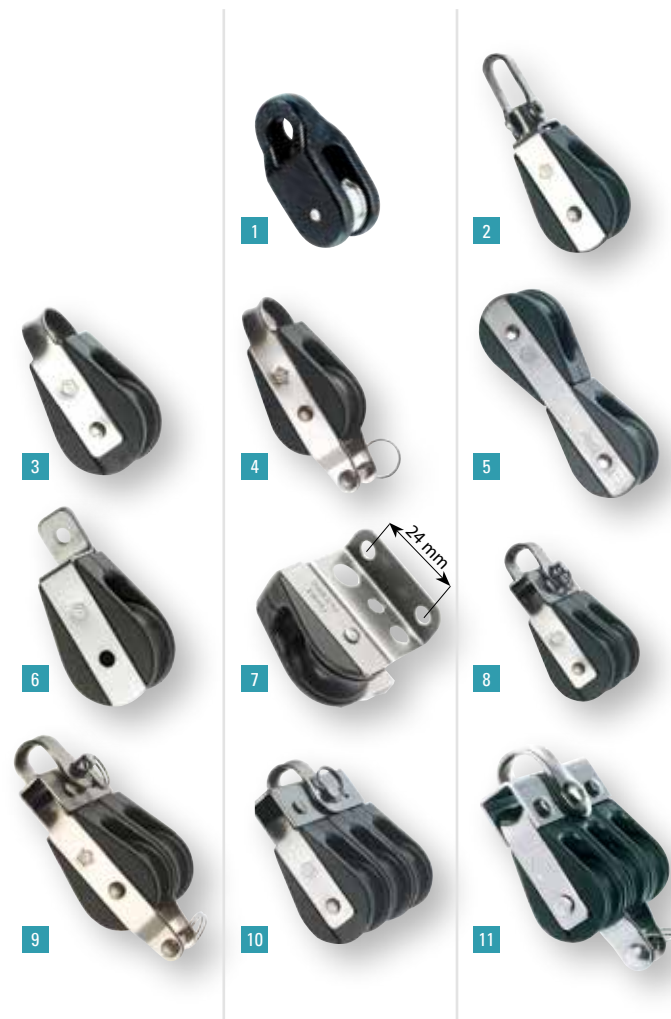

Blocks

plain bearing and ball bearing

SHEAVE DIA 35

+ BENEFITS

- Large range
- Universal head allows wide choice of fastenings
- High resistance under high loads
- Modern design
- Sheave protected by cheeks
- Load bearing stainless steel shaft
- Adjustable cam cleats
- For following rope diameters: 8, 9, 10, 12 and 14 mm



SHEAVE DIA 35

rope size 8 to 9 mm, forged shackle 5 mm

| N° | Part plain bear. | Part ball bear. | Description | Height mm | Width mm | Thick. mm | W.L. Kg | B.L. Kg | Weight Kg |
|----------------------|------------------|-----------------|---------------------------------|-----------|----------|-----------|---------|---------|-----------|
| SINGLE BLOCKS | | | | | | | | | |
| 1 | 62105 | 72105 | Swivel head | 84 | 37 | 23 | 320 | 900 | 0.071 |
| 2 | 62106 | 72106 | Swivel head with becket | 101 | 37 | 23 | 320 | 900 | 0.079 |
| 3 | 62108 | 72108 | Swivel head with becket and cam | 101 | 64 | 45 | 200 | 900 | 0.118 |
| 5 | 62117 | 72117 | Fixed head with clevis | 72 | 37 | 23 | 320 | 500 | 0.055 |
| 6 | 62113 | 72113 | Fixed eye | 65 | 37 | 23 | 320 | 900 | 0.051 |
| 7 | 62120 | 72120 | Cheek block, bolts 6 mm dia | 52 | 37 | 20 | 320 | 900 | 0.044 |
| 10 | 62121 | 72121 | Upright block | 42 | 46 | 40 | 320 | 900 | 0.053 |
| 11 | 62122 | - | Reefing block | 60 | 58 | 40 | 320 | 900 | 0.103 |
| 8 | 62131 | 72131 | Swivel snap hook | 102 | 37 | 23 | 200 | 400 | 0.076 |
| DOUBLE BLOCKS | | | | | | | | | |
| 12 | 62205 | 72205 | Swivel head | 84 | 37 | 40 | 480 | 900 | 0.119 |
| 13 | 62206 | 72206 | Swivel head with becket | 101 | 37 | 40 | 480 | 900 | 0.128 |
| TRIPLE BLOCKS | | | | | | | | | |
| 15 | 62305 | 72305 | Swivel head | 84 | 37 | 58 | 560 | 1000 | 0.149 |
| 16 | 62306 | 72306 | Swivel head with becket | 101 | 37 | 58 | 560 | 1000 | 0.157 |
| 17 | 62308 | 72308 | Swivel head with becket and cam | 101 | 66 | 60 | 200 | 1000 | 0.208 |
| FIDDLE BLOCKS | | | | | | | | | |
| 18 | 62405 | 72405 | Swivel head | 107 | 37 | 23 | 320 | 900 | 0.086 |
| 20 | 62408 | 72408 | Swivel head with becket and cam | 124 | 64 | 45 | 200 | 900 | 0.138 |

Blocks

plain bearing and ball bearing

SHEAVE DIA 45



SHEAVE DIA 45

rope size 10 mm, forged shackle 5 mm

| N° | Part plain bear. | Part ball bear. | Description | Height mm | Width mm | Thick. mm | W.L. Kg | B.L. Kg | Weight Kg |
|----------------------|------------------|-----------------|---|-----------|----------|-----------|---------|---------|-----------|
| SINGLE BLOCKS | | | | | | | | | |
| 1 | 63105 | 73105 | Swivel head | 97 | 49 | 26 | 400 | 900 | 0.105 |
| 2 | 63106 | 73106 | Swivel head with becket | 117 | 49 | 26 | 400 | 900 | 0.120 |
| 3 | 63108 | 73108 | Swivel head with becket and cam | 117 | 86 | 61 | 280 | 900 | 0.211 |
| 4 | 63109 | - | Swivel with clevis | 98 | 49 | 26 | 400 | 700 | 0.101 |
| 4 | 63117 | 73117 | Fixed head with clevis | 87 | 49 | 26 | 400 | 700 | 0.089 |
| 5 | 63113 | 73113 | Fixed eye | 78 | 49 | 26 | 400 | 900 | 0.083 |
| 8 | 63118 | 73118 | Webbing D ring | 93 | 49 | 26 | 400 | 900 | 0.108 |
| 6 | 63120 | 73120 | Cheek block, bolts 6 mm dia | 65 | 49 | 23 | 400 | 900 | 0.073 |
| DOUBLE BLOCKS | | | | | | | | | |
| 12 | 63205 | 73205 | Swivel head | 97 | 49 | 46 | 480 | 1000 | 0.184 |
| 13 | 63206 | 73206 | Swivel head with becket | 117 | 49 | 46 | 480 | 1000 | 0.199 |
| 14 | 63207 | 73207 | Swivel snap shackle | 110 | 49 | 46 | 480 | 1000 | 0.208 |
| TRIPLE BLOCKS | | | | | | | | | |
| 15 | 63305 | 73305 | Swivel head | 97 | 49 | 67 | 560 | 1000 | 0.243 |
| 16 | 63306 | 73306 | Swivel head with becket | 117 | 49 | 67 | 560 | 1000 | 0.257 |
| 17 | 63308 | 73308 | Swivel head with becket and cam | 117 | 87 | 72 | 360 | 1000 | 0.357 |
| FIDDLE BLOCKS | | | | | | | | | |
| 18 | 63405 | 73405 | Swivel head | 130 | 49 | 26 | 560 | 1000 | 0.147 |
| 19 | 63406 | 73406 | Swivel head with becket | 150 | 49 | 26 | 560 | 1000 | 0.156 |
| 21 | 63407 | 73407 | Swivel head with cam | 130 | 86 | 61 | 360 | 1000 | 0.240 |
| 20 | 63408 | 73408 | Swivel head with becket and cam | 150 | 86 | 61 | 360 | 1000 | 0.249 |
| 22 | 63435 | 73435 | Swivel snap shackle | 143 | 49 | 26 | 560 | 1000 | 0.171 |
| 23 | 63438 | 73438 | Swivelling snap shackle with becket and cam | 163 | 86 | 61 | 360 | 1000 | 0.273 |

WL: working load - BL: breaking load



15



16



17



18



19



20



21



22



23

Blocks

plain bearing and ball bearing

SHEAVE 55 AND 70

+ BENEFITS

- Large range
- Universal head allows wide choice of fastenings
- High resistance under high loads
- Modern design
- Sheave protected by cheeks
- Load bearing stainless steel shaft
- Adjustable cam cleats
- For following rope diameters: 8, 9, 10, 12 and 14 mm

SHEAVE DIA 55

rope size 12 mm, forged shackle 6 mm

| N° | Part plain bear. | Part ball bear. | Description | Height mm | Width mm | Thick. mm | W.L. Kg | B.L. Kg | Weight Kg |
|----------------------|------------------|-----------------|---------------------------------|-----------|----------|-----------|---------|---------|-----------|
| SINGLE BLOCKS | | | | | | | | | |
| 1 | 64105 | 74105 | Swivel head | 119 | 63 | 29 | 720 | 1500 | 0.179 |
| 2 | 64106 | 74106 | Swivel head with becket | 144 | 63 | 29 | 720 | 1500 | 0.200 |
| 3 | 64108 | 74108 | Swivel head with becket and cam | 144 | 95 | 61 | 480 | 1500 | 0.302 |
| 8 | 64109 | 74109 | Swivel with clevis | 113 | 63 | 29 | 640 | 1000 | 0.159 |
| 9 | 64110 | 74110 | Swivel with clevis and becket | 138 | 63 | 29 | 640 | 1000 | 0.185 |
| 4 | 64117 | 74117 | Fixed head with clevis | 107 | 63 | 29 | 720 | 1200 | 0.157 |
| 5 | 64113 | 74113 | Fixed eye | 98 | 63 | 29 | 720 | 1500 | 0.138 |
| 6 | 64118 | 74118 | Webbing D ring | 110 | 63 | 29 | 720 | 1500 | 0.166 |
| 7 | 64130 | 74130 | Swivelling snap shackle | 126 | 63 | 29 | 720 | 1500 | 0.184 |
| 10 | 64120 | 74120 | Cheek block, bolts 6 mm dia | 81 | 63 | 26 | 720 | 1500 | 0.123 |

DOUBLE BLOCKS

| | | | | | | | | | |
|----|-------|-------|-------------------------|-----|----|----|-----|------|-------|
| 11 | 64205 | 74205 | Swivel head | 119 | 63 | 52 | 800 | 1500 | 0.315 |
| 12 | 64206 | 74206 | Swivel head with becket | 144 | 63 | 52 | 800 | 1500 | 0.337 |

TRIPLE BLOCKS

| | | | | | | | | | |
|----|-------|-------|---------------------------------|-----|----|----|-----|------|-------|
| 13 | 64305 | 74305 | Swivel head | 119 | 63 | 75 | 880 | 1500 | 0.410 |
| 14 | 64306 | 74306 | Swivel head with becket | 144 | 63 | 75 | 880 | 1500 | 0.429 |
| 15 | 64308 | 74308 | Swivel head with becket and cam | 144 | 97 | 81 | 480 | 1500 | 0.550 |

FIDDLE BLOCKS

| | | | | | | | | | |
|----|-------|-------|---|-----|----|----|-----|------|-------|
| 16 | 64405 | 74405 | Swivel head | 160 | 63 | 29 | 800 | 1500 | 0.247 |
| 17 | 64406 | 74406 | Swivel head with becket | 186 | 63 | 29 | 800 | 1500 | 0.270 |
| 18 | 64408 | 74408 | Swivel head with becket and cam | 186 | 95 | 61 | 480 | 1500 | 0.374 |
| 19 | 64435 | 74435 | Swivelling snap shackle | 167 | 63 | 29 | 800 | 1500 | 0.253 |
| 20 | 64438 | 74438 | Swivelling snap shackle with becket and cam | 193 | 95 | 61 | 480 | 1500 | 0.380 |

WL: working load - BL: breaking load





SHEAVE DIA 70

rope size 14 mm, forged shackle 8 mm

| N° | Part plain bear. | Part ball bear. | Description | Height mm | Width mm | Thick. mm | W.L. Kg | B.L. Kg | Weight Kg |
|----------------------|------------------|-----------------|---|-----------|----------|-----------|---------|---------|-----------|
| SINGLE BLOCKS | | | | | | | | | |
| 1 | 65105 | 75105 | Swivel head | 153 | 80 | 39 | 1200 | 2700 | 0.367 |
| 2 | 65106 | 75106 | Swivel head with becket | 183 | 80 | 39 | 1200 | 2700 | 0.416 |
| 3 | 65108 | 75108 | Swivel head with becket and cam | 183 | 120 | 80 | 480 | 2700 | 0.599 |
| 8 | 65109 | 75109 | Swivel with clevis | 137 | 80 | 39 | 800 | 1500 | 0.357 |
| 4 | 65117 | 75117 | Fixed head with clevis | 132 | 80 | 39 | 1200 | 2000 | 0.320 |
| 7 | 65130 | 75130 | Swivelling snap shackle | 162 | 80 | 39 | 1200 | 2700 | 0.395 |
| 10 | 65120 | 75120 | Cheek block, bolts 8 mm dia | 103 | 80 | 34 | 1200 | 2700 | 0.294 |
| DOUBLE BLOCKS | | | | | | | | | |
| 11 | 65205 | 75205 | Swivel head | 153 | 80 | 68 | 1440 | 2700 | 0.653 |
| 12 | 65206 | 75206 | Swivel head with becket | 183 | 80 | 68 | 1440 | 2700 | 0.714 |
| TRIPLE BLOCKS | | | | | | | | | |
| 13 | 65305 | 75305 | Swivel head | 153 | 80 | 97 | 1600 | 2700 | 0.895 |
| 14 | 65306 | 75306 | Swivel head with becket | 183 | 80 | 97 | 1600 | 2700 | 0.941 |
| 15 | 65308 | 75308 | Swivel head with becket and cam | 183 | 123 | 101 | 480 | 2700 | 1.139 |
| FIDDLE BLOCKS | | | | | | | | | |
| 16 | 65405 | 75405 | Swivel head | 204 | 80 | 39 | 1440 | 2700 | 0.518 |
| 17 | 65406 | 75406 | Swivel head with becket | 236 | 80 | 39 | 1440 | 2700 | 0.570 |
| 18 | 65408 | 75408 | Swivel head with becket and cam | 236 | 120 | 80 | 480 | 2700 | 0.748 |
| 19 | 65435 | 75435 | Swivelling snap shackle | 213 | 80 | 39 | 1440 | 2700 | 0.570 |
| 20 | 65438 | 75438 | Swivelling snap shackle with becket and cam | 245 | 120 | 80 | 480 | 2700 | 0.790 |

WL: working load - BL: breaking load

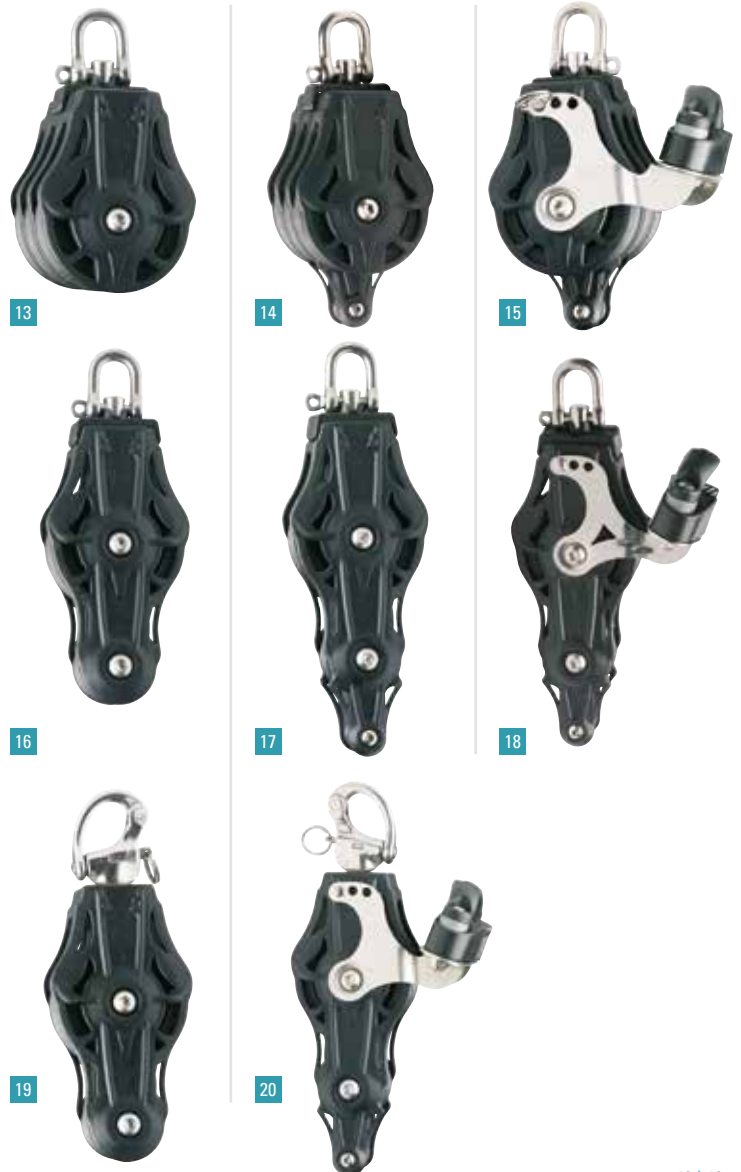

Roller Blocks*

SHEAVE 30, 40, 50



Roller blocks

Wichard roller bearing blocks are designed to be simple, reliable and long-lasting. They are ideal for dynamic running rigging that is subject to heavy loads (mainsail tackle, mastfoot block, etc.).



1



2



3



4



5



6



7



8



9



10



11



12



13



14

| N° | Part # | Description | Height mm | Width mm | Thick mm | W.L. Kg | B.L. Kg | Weight Kg |
|---|--------|---------------------------------|-----------|----------|----------|---------|---------|-----------|
| SINGLE BLOCKS: SHEAVE 30 FOR ROPE SIZE 6 TO 10 MM - SHACKLE 4 MM | | | | | | | | |
| 1 | 90105 | Swivel head | 63 | 31 | 20 | 144 | 700 | 0,048 |
| 2 | 90106 | Swivel head with becket | 80 | 31 | 20 | 144 | 700 | 0,054 |
| SINGLE BLOCKS: SHEAVE 40 FOR ROPE SIZE 8 TO 10 MM - SHACKLE 5 MM | | | | | | | | |
| 1 | 93105 | Swivel head | 80 | 42 | 27 | 320 | 900 | 0,104 |
| 2 | 93106 | Swivel head with becket | 96 | 42 | 27 | 320 | 900 | 0,100 |
| 4 | 93120 | Cheeks block - bolts M5 | 67 | 42 | 25 | 320 | 900 | 0,106 |
| DOUBLE BLOCK: SHEAVE 40 FOR ROPE SIZE 8 TO 10 MM - SHACKLE 5 MM | | | | | | | | |
| 5 | 93205 | Swivel head | 80 | 42 | 47 | 320 | 1000 | 0,128 |
| SINGLE BLOCKS: SHEAVE 50 FOR ROPE SIZE 8 TO 10 MM - SHACKLE 6 MM | | | | | | | | |
| 1 | 94105 | Swivel head | 93 | 52 | 28 | 480 | 1500 | 0,138 |
| 2 | 94106 | Swivel head with becket | 113 | 52 | 28 | 480 | 1500 | 0,124 |
| 3 | 94108 | Swivel head with becket and cam | 113 | 102 | 60 | 480 | 1500 | 0,248 |
| 4 | 94120 | Cheeks block - bolts M5 | 78 | 52 | 25 | 480 | 1500 | 0,152 |
| DOUBLE BLOCKS: SHEAVE 50 FOR ROPE SIZE 8 TO 10 MM - SHACKLE 6 MM | | | | | | | | |
| 5 | 94205 | Swivel head | 93 | 52 | 48 | 640 | 1600 | 0,210 |
| 6 | 94206 | Swivel head with becket | 113 | 52 | 48 | 640 | 1600 | 0,226 |
| TRIPLE BLOCKS: SHEAVE 50 FOR ROPE SIZE 8 TO 10 MM - SHACKLE 6 MM | | | | | | | | |
| 7 | 94305 | Swivel head | 93 | 52 | 68 | 640 | 1600 | 0,284 |
| 8 | 94306 | Swivel head with becket | 113 | 52 | 68 | 640 | 1600 | 0,292 |
| 9 | 94307 | Swivel head and cam | 93 | 102 | 60 | 480 | 1600 | 0,380 |
| 10 | 94308 | Swivel head with becket and cam | 113 | 102 | 60 | 480 | 1600 | 0,392 |
| FIDDLE BLOCKS: SHEAVE 50 FOR ROPE SIZE 8 TO 10 MM - SHACKLE 6 MM | | | | | | | | |
| 11 | 94405 | Swivel head | 130 | 52 | 28 | 480 | 1500 | 0,174 |
| 12 | 94406 | Swivel head with becket | 150 | 52 | 28 | 480 | 1500 | 0,182 |
| 13 | 94407 | Swivel head and cam | 130 | 102 | 60 | 480 | 1500 | 0,278 |
| 14 | 94408 | Swivel head with becket and cam | 150 | 102 | 60 | 480 | 1500 | 0,284 |

* SPECIFIC PARTS: AVAILABILITY UPON REQUEST

Roller Blocks*

SHEAVE 65, 80

COMPONENTS: ROLLER BEARING BLOCKS

1. Forged stainless-steel shackle (HR s-steel for HR models).
2. Stainless-steel swivel head
3. 316L stainless-steel bolt
4. Aluminium cheeks (hard coat anodization)
5. Delrin® roller bearings (Torlon® for HR models).
6. Centring bush for lateral loads
7. Stainless-steel circlip
8. Hard anodized aluminium sheave (+ Teflon for HR models).
9. Hard anodized aluminium hollow pin (+ Teflon for HR models).

| N° | Part # | Description | Height mm | Width mm | Thick. mm | W.L. Kg | B.L. Kg | Weight Kg |
|--|--------|---------------------------------|-----------|----------|-----------|---------|---------|-----------|
| SINGLE BLOCKS - SHEAVE 65 FOR ROPE SIZE 8 TO 12 MM - SHACKLE 8 MM | | | | | | | | |
| 1 | 95105 | Swivel head | 112 | 68 | 30 | 600 | 1800 | 0,218 |
| 2 | 95106 | Swivel head with becket | 134 | 68 | 30 | 600 | 1800 | 0,232 |
| 3 | 95108 | Swivel head with becket and cam | 134 | 118 | 60 | 480 | 1800 | 0,338 |
| 4 | 95120 | Cheeks block - bolts M5 | 94 | 68 | 26 | 600 | 1800 | 0,200 |
| DOUBLE BLOCKS - SHEAVE 65 FOR ROPE SIZE 8 TO 12 MM - SHACKLE 8 MM | | | | | | | | |
| 5 | 95205 | Swivel head | 112 | 68 | 50 | 720 | 1800 | 0,278 |
| 6 | 95206 | Swivel head with becket | 134 | 68 | 50 | 720 | 1800 | 0,282 |
| 7 | 95220 | Cheeks block - bolts M5 | 94 | 68 | 48 | 520 | 1800 | 0,314 |
| TRIPLE BLOCKS - SHEAVE 65 FOR ROPE SIZE 8 TO 12 MM - SHACKLE 8 MM | | | | | | | | |
| 8 | 95305 | Swivel head | 112 | 68 | 70 | 720 | 1800 | 0,418 |
| 9 | 95306 | Swivel head with becket | 134 | 68 | 70 | 720 | 1800 | 0,422 |
| 10 | 95307 | Swivel head and cam | 112 | 118 | 60 | 480 | 1800 | 0,514 |
| 11 | 95308 | Swivel head with becket and cam | 134 | 118 | 60 | 480 | 1800 | 0,534 |
| FIDDLE BLOCKS - SHEAVE 65 FOR ROPE SIZE 8 TO 12 MM - SHACKLE 8 MM | | | | | | | | |
| 12 | 95405 | Swivel head | 158 | 68 | 30 | 600 | 1800 | 0,268 |
| 13 | 95406 | Swivel head with becket | 180 | 68 | 30 | 600 | 1800 | 0,280 |
| 14 | 95310 | Swivel head triple sheave | 158 | 68 | 70 | 600 | 1800 | 0,466 |
| 15 | 95407 | Swivel head and cam | 158 | 118 | 60 | 480 | 1800 | 0,374 |
| 16 | 95408 | Swivel head with becket and cam | 180 | 118 | 60 | 480 | 1800 | 0,382 |
| SINGLE BLOCKS - SHEAVE 80 FOR ROPE SIZE 8 TO 12 MM - SHACKLE 8 MM | | | | | | | | |
| 1 | 96105 | Swivel head | 128 | 83 | 27 | 1000 | 2050 | 0,280 |
| 2 | 96106 | Swivel head with becket | 154 | 83 | 27 | 1000 | 2050 | 0,294 |
| 4 | 96120 | Cheeks block - bolts M5 | 110 | 83 | 25 | 1000 | 2050 | 0,268 |
| DOUBLE BLOCKS - SHEAVE 80 FOR ROPE SIZE 8 TO 12 MM - SHACKLE 8 MM | | | | | | | | |
| 5 | 96205 | Swivel head | 128 | 83 | 47 | 720 | 2050 | 0,374 |
| 7 | 96220 | Cheeks block - bolts M5 | 110 | 83 | 44 | 800 | 2050 | 0,430 |



* SPECIFIC PARTS: AVAILABILITY UPON REQUEST

HR Roller Blocks*

SHEAVE 65, 80, 100, 125, 160, 200, 240



| N° | Part # | Description | Ø shackle mm | Height mm | Width mm | Thick. mm | W.L. Kg | B.L. Kg | Weight Kg |
|--|--------|-------------------------|--------------|-----------|----------|-----------|---------|---------|-----------|
| SINGLE BLOCKS: ALUMINIUM SHEAVE 65 - ROPE SIZE 8 TO 12 MM | | | | | | | | | |
| 1 | 41105 | Swivel head | 6 | 106 | 67 | 31 | 1000 | 2700 | 0,198 |
| 2 | 41106 | Swivel head with becket | 8 | 132 | 67 | 31 | 1000 | 2700 | 0,280 |
| DOUBLE BLOCK: ALUMINIUM SHEAVE 65 - ROPE SIZE 8 TO 12 MM | | | | | | | | | |
| 4 | 41205 | Swivel head | 10 | 125 | 67 | 54 | 1000 | 2700 | 0,478 |
| SINGLE BLOCKS: ALUMINIUM SHEAVE 80 - ROPE SIZE 12 TO 14 MM | | | | | | | | | |
| 1 | 42105 | Swivel head | 8 | 133 | 83 | 35 | 1600 | 4000 | 0,396 |
| 2 | 42106 | Swivel head with becket | 10 | 165 | 83 | 35 | 1600 | 4000 | 0,484 |
| 3 | 42120 | Cheek block - bolts M5 | - | 112 | 83 | 33 | 1600 | 4000 | 0,488 |
| DOUBLE BLOCKS: ALUMINIUM SHEAVE 80 - ROPE SIZE 12 TO 14 MM | | | | | | | | | |
| 4 | 42205 | Swivel head | 12 | 155 | 83 | 57 | 1600 | 4000 | 0,868 |
| 5 | 42220 | Cheek block - bolts M8 | - | 112 | 83 | 55 | 1600 | 4000 | 0,728 |
| SINGLE BLOCKS: ALUMINIUM SHEAVE 100 - ROPE SIZE 16 TO 18 MM | | | | | | | | | |
| 1 | 43105 | Swivel head | 10 | 165 | 104 | 39 | 2000 | 5000 | 0,692 |
| 2 | 43106 | Swivel head with becket | 12 | 200 | 104 | 39 | 2000 | 5000 | 0,904 |
| 3 | 43120 | Cheek block - bolts M10 | - | 142 | 104 | 36 | 2000 | 5000 | 0,900 |
| DOUBLE BLOCKS: ALUMINIUM SHEAVE 100 - ROPE SIZE 16 TO 18 MM | | | | | | | | | |
| 4 | 43205 | Swivel head | 14 | 195 | 104 | 68 | 2000 | 5000 | 1,648 |
| 5 | 43220 | Cheek block - bolts M10 | - | 142 | 104 | 65 | 2000 | 5000 | 1,386 |
| SINGLE BLOCKS: ALUMINIUM SHEAVE 125 - ROPE SIZE 18 TO 20 MM | | | | | | | | | |
| 1 | 44105 | Swivel head | 12 | 204 | 130 | 45 | 4000 | 9500 | 1,314 |
| 2 | 44106 | Swivel head with becket | 14 | 250 | 130 | 45 | 4000 | 9500 | 1,514 |
| 3 | 44120 | Cheek block - bolts M12 | - | 177 | 130 | 42 | 4000 | 9500 | 1,464 |
| DOUBLE BLOCK: ALUMINIUM SHEAVE 125 - ROPE SIZE 18 TO 20 MM | | | | | | | | | |
| 5 | 44220 | Cheek block - bolts M12 | - | 177 | 130 | 73 | 4000 | 9500 | 2,240 |
| SINGLE BLOCKS: ALUMINIUM SHEAVE 160 - ROPE SIZE 20 TO 24 MM | | | | | | | | | |
| 1 | 45105 | Swivel head | 14 | 255 | 165 | 51 | 5000 | 11000 | 2,768 |
| 2 | 45106 | Swivel head with becket | 16 | 315 | 165 | 51 | 5000 | 11000 | 2,940 |
| 3 | 45120 | Cheek block - bolts M16 | - | 223 | 165 | 49 | 5000 | 11000 | 2,962 |
| DOUBLE BLOCK: ALUMINIUM SHEAVE 160 - ROPE SIZE 20 TO 24 MM | | | | | | | | | |
| 5 | 45220 | Cheek block - bolts M16 | - | 223 | 165 | 84 | 5000 | 11000 | 4,516 |
| SINGLE BLOCKS: ALUMINIUM SHEAVE 200 - ROPE SIZE 24 TO 26 MM | | | | | | | | | |
| 1 | 46105 | Swivel head | 20 | 325 | 209 | 61 | 8000 | 20000 | 4,804 |
| 2 | 46106 | Swivel head with becket | 20 | 410 | 209 | 61 | 8000 | 20000 | 5,026 |
| 3 | 46120 | Cheek block - bolts M16 | - | 280 | 209 | 58 | 8000 | 20000 | 4,722 |
| DOUBLE BLOCK: ALUMINIUM SHEAVE 200 - ROPE SIZE 24 TO 26 MM | | | | | | | | | |
| 5 | 46220 | Cheek block - bolts M16 | - | 280 | 209 | 99 | 8000 | 20000 | 7,752 |
| SINGLE BLOCKS: ALUMINIUM SHEAVE 240 - ROPE SIZE 26 TO 30 MM | | | | | | | | | |
| 1 | 47105 | Swivel head | 24 | 380 | 245 | 69 | 12000 | 28000 | 7,320 |
| 3 | 47120 | Cheek block - bolts M20 | - | 325 | 240 | 65 | 12000 | 28000 | 6,994 |
| DOUBLE BLOCK: ALUMINIUM SHEAVE 240 - ROPE SIZE 26 TO 30 MM | | | | | | | | | |
| 5 | 47220 | Cheek block - bolts M20 | - | 325 | 240 | 130 | 12000 | 28000 | 10,950 |

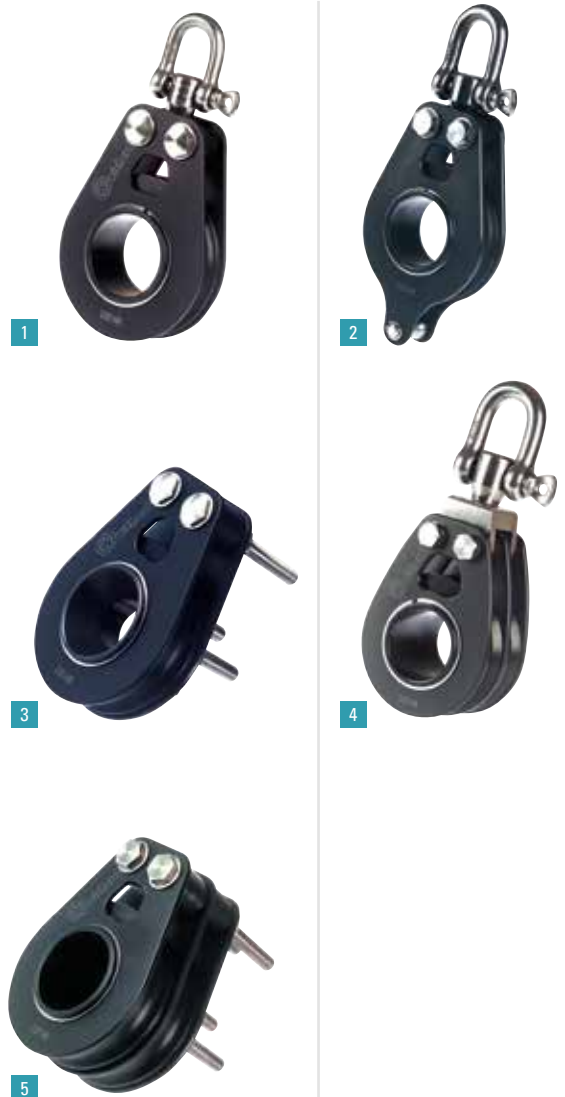

* SPECIFIC PARTS: AVAILABILITY UPON REQUEST

Soft snatch blocks



- 6 models available from 2T to 15T
- Various applications on board
- High resistance and lighthness
- Easy and fast installation thanks to Dyneema® loop
- Fast and safe opening / closing with the Velcro® strap
- Modern design
- Sheave protection by the cheeks
- Material: anodised aluminium (cheeks & sheave), Dyneema® loop, stainless steel dogbone

APPLICATIONS :

- Flying sail furler terminals (2:1 gennaker halyard)
- Main sail (2:1)
- Barber-hauler
- Sheets
- ...

| N° | Part # | Description | A: Rope dia mm | B mm | C: sheave dia mm | Loop dia mm | W.L. Kg | B.L. Kg | Weight Kg |
|--------------------------|--------|----------------|----------------|------|------------------|-------------|---------|---------|-----------|
| SOFT SNATCH BLOCK | | | | | | | | | |
| | 36010 | For 10 mm rope | 8 | 59 | 41 | 5 | 2000 | 4000 | 0.099 |
| | 36020 | For 12 mm rope | 10 | 64 | 46 | 6 | 3000 | 6000 | 0.141 |
| 1 | 36030 | For 16 mm rope | 14 | 79 | 55 | 8 | 4500 | 9000 | 0.249 |
| | 36040 | For 20 mm rope | 18 | 90 | 70 | 10 | 7000 | 14000 | 0.461 |
| | 36050 | For 24 mm rope | 22 | 110 | 88 | 15 | 9000 | 18000 | 0.897 |
| | 36060 | For 32 mm rope | 30 | na | 123 | 18 | 15000 | 30000 | 1.990 |



Snatch blocks with snap shackle

Fitted to a pad eye or toe rail Wichard snatch blocks are highly useful for taking up a rope that is already reeved. The elastomer moulded cheeks make them shock and scratch-resistant. Each one is fitted with a snap shackle which allows them to move freely in any position. With its forged high-resistance stainless steel arm, the closing system is very strong. It can be opened very easily by pulling on the central plunger pin, as you would do with a normal snap shackle.



| N° | Part # | Description | Height mm | Width mm | Thick. mm | W.L. Kg | B.L. Kg | Weight Kg |
|----------------------|--------|-----------------------|-----------|----------|-----------|---------|---------|-----------|
| SNATCH BLOCKS | | | | | | | | |
| 1 | 34500 | Max. 12 mm diam. rope | 145 | 59 | 43 | 720 | 1300 | 0.254 |
| 1 | 35500 | Max. 18 mm diam. rope | 155 | 59 | 49 | 1200 | 2500 | 0.414 |

Stainless steel snatch block

This stainless steel snatch block can be used for any application. The design makes its positioning easier. The all stainless steel construction is a guarantee of safety and reliability.

STAINLESS STEEL SNATCH BLOCK

rope size 6 mm

| N° | Part # | Description | Height mm | Width mm | Thick. mm | W.L. Kg | B.L. Kg | Weight Kg |
|---------------------|--------|--------------------|-----------|----------|-----------|---------|---------|-----------|
| SINGLE BLOCK | | | | | | | | |
| 2 | 31031 | Max rope size 6 mm | 127 | 50 | 17.5 | 200 | 300 | 0.124 |



Deck accessories

| N° | Part # | Description | Weight Kg |
|----|--------|-------------|-----------|
|----|--------|-------------|-----------|

| SWIVEL BASE | | | |
|-------------|-------|---|-------|
| 1 | 30101 | Mainsheet swivel base - ball bearing- rope size 12 mm | 0.308 |
| 2 | 30103 | Swivel cleat base - rope size 12 mm | 0.160 |
| 3 | 30105 | Swivel cleat base - rope size 12 mm | 0.178 |

| N° | Part # | For rope Ø / mm | Fastener spacing mm | Weight Kg |
|----|--------|-----------------|---------------------|-----------|
|----|--------|-----------------|---------------------|-----------|

| Cam cleats | | | | |
|------------|-------|----|----|-------|
| 4 | 30006 | 8 | 26 | 0.017 |
| | 30012 | 12 | 38 | 0.044 |
| | 30016 | 16 | 52 | 0.068 |

| STAND UP SPRINGS | | |
|------------------|-------|---|
| 5 | 32530 | Stand up spring without collar for sheaves dia 18 & 25 mm |
| | 32540 | Stand up spring with collar for sheaves dia 35 & 45 mm |
| | 32550 | Stand up spring with collar for sheaves dia 55 & 70 mm |

| N° | Part # | Description | For blocks | Clevis Ø mm | Ø Pin mm | Weight Kg |
|----|--------|-------------|------------|-------------|----------|-----------|
|----|--------|-------------|------------|-------------|----------|-----------|

| CLEVIS ADAPTOR | | | | | | |
|----------------|-------|------------------------|--------------|----|---|-------|
| 6 | 32570 | Swivel, clevis adaptor | Sheave 35&45 | 8 | 5 | 0.024 |
| | 32571 | Swivel, clevis adaptor | Sheave 55 | 10 | 6 | 0.023 |

| MAST STEP ADAPTOR | | | |
|-------------------|-------|---|-------|
| 7 | 32580 | Mast step adaptor for Part # 63117 & 73117 - Ø drilling: 5.2 mm | 0.034 |
| | 32581 | Mast step adaptor for Part # 64117 & 74117 - Ø drilling: 8.2 mm | 0.042 |

| N° | Part # | Height mm | Fastener spacing mm | For rope Ø mm | Weight Kg |
|----|--------|-----------|---------------------|---------------|-----------|
|----|--------|-----------|---------------------|---------------|-----------|

| SADDLES STAINLESS STEEL | | | | | |
|-------------------------|-------|----|----|----|-------|
| 8 | 30026 | 11 | 26 | 8 | 0.003 |
| | 30038 | 15 | 38 | 12 | 0.010 |
| | 30052 | 21 | 52 | 16 | 0.016 |

| SADDLES POM | | | | | |
|-------------|-------|------|----|----|-------|
| 9 | 30126 | 14,5 | 26 | 8 | 0.002 |
| | 30138 | 19 | 38 | 12 | 0.007 |
| | 30152 | 22,5 | 52 | 16 | 0.009 |

| N° | Part # | Description | Ø Sheave mm | Thickness mm | Ø Pin mm | Ø rope mm |
|----|--------|-------------|-------------|--------------|----------|-----------|
|----|--------|-------------|-------------|--------------|----------|-----------|

| PLAIN BEARING SHEAVES | | | | | | |
|-----------------------|-------|--------|----|------|----|----|
| 10 | 60081 | Sheave | 18 | 8,5 | 6 | 4 |
| | 60082 | Sheave | 25 | 10,5 | 6 | 6 |
| | 60083 | Sheave | 35 | 11,5 | 10 | 8 |
| | 60084 | Sheave | 45 | 13 | 10 | 10 |
| | 60085 | Sheave | 55 | 15 | 10 | 12 |
| | 60086 | Sheave | 70 | 19 | 14 | 14 |
| | 60087 | Sheave | 80 | 22 | 17 | 18 |

| SHEAVES WITH CAPTIVE BALLS | | | | | | |
|----------------------------|-------|---------------|----|----|----|----|
| 11 | 80085 | Captive balls | 55 | 15 | 10 | 12 |
| | 80086 | Captive balls | 70 | 19 | 14 | 14 |
| | 80088 | Captive balls | 32 | 15 | 10 | 10 |
| | 80089 | Captive balls | 42 | 19 | 14 | 18 |

DECK ORGANIZERS: BALL BEARINGS SHEAVES (STACKED)

| N° | Part # | Sheaves | Ø Sheave mm | Ø Rope mm | Length mm | Width mm | Thickness mm | Fastener mm | Ø Pin mm | Weight Kg |
|----|--------|---------|-------------|-----------|-----------|----------|--------------|-------------|----------|-----------|
| 12 | 81512 | 2 | 32 | 4 to 12 | 95 | 35 | 22 | 43 | 6 | 0.070 |
| 13 | 81513 | 3 | 32 | 4 to 12 | 140 | 35 | 22 | 43 | 6 | 0.106 |
| 14 | 81514 | 4 | 32 | 4 to 12 | 180 | 35 | 22 | 43 | 6 | 0.140 |
| 12 | 81522 | 2 | 42 | 8 to 16 | 125 | 45 | 28 | 57 | 8 | 0.156 |
| 13 | 81523 | 3 | 42 | 8 to 16 | 185 | 45 | 28 | 57 | 8 | 0.231 |
| 14 | 81524 | 4 | 42 | 8 to 16 | 240 | 45 | 28 | 57 | 8 | 0.305 |

For sport boats or dinghies, swivel bases enable the boat's fittings to be optimised. They are manufactured according to Wichard tradition of quality, and form part of the original equipment on many modern designs. Their dimensions and the adjustable orientation of the cam cleats, mean they can be installed on your boat without any modifications.





Safety

Tethers, Gyb'Easy the Wichard boom brake, Lyf'safe, the jacklines kit

Wichard designs cutting-edge technology products whose main function is to provide enhanced safety.

They are robust, easy to use and will bring you satisfaction.



Boom brake

Gyb'Easy



Gybing remains one of the most challenging operations on a sailing boat even for experienced sailors and can possibly generate injuries and material damage.
An efficient and safe solution: Gyb'Easy the Wichard boom brake.

Concept

Thanks to the frictions of the specific line passing over the boom break, the boom is allowed to gybe smoothly. With Gyb'Easy, the gybe operations are safer, potential accidents reduced and without jerks.

Settings of Gyb'Easy

The adjustment of Gyb'Easy is made thanks to the tension of the specialized line. 3 different positions exist for a perfect adaptation to the mainsail and wind conditions (see pictures).

The more the line passes over the openings, the more the friction is increased and hence the brake efficiency.

Setting 1

Setting 2

Setting 3



An easy installation on all kinds of boats

The installation only takes a few minutes: a shackle is attached onto one of the boom eye straps. In order to fit with all deck configurations, two different fittings can be implemented. The boom brake can be installed either on modern boats or old gaffers.

Features:

- Can be used on mainsail areas below 40 sqm.
- Material: aluminium with anodisation.
- Weight: 0.600 kg.
- Part #: 7150 (delivered with rope and shackle). Part # 1244
- Rope available in two lengths 16 und 25 m



Visit our **Wichard Sailing**
You Tube channel and download
the **Gyb'Easy** video

Jacklines

Lyf'Safe

The Wichard jackline

Universal, Ready-to-use, Reflective

Either sailing solo or fully crewed, operating on the foredeck in most conditions require extra attention and safety precautions. Lyf'Safe by Wichard is a complete jackline kit allowing safer operations and offering added value to the crew.

Adaptable and universal

Lyf'Safe can be tailored to the length of the boat (using the adjuster) and can be fitted on to most deck fastenings (padeyes, pulpit/pushpit, cleats).

Ready-to-use

Easy to install, Lyf'Safe does not require additional fastening components such as shackles.

Reflective

Thanks to its reflective stripe and photoluminescent casing, Lyf'Safe can be easily identified when sailing at night.

Locking system of the webbing

The adjuster casing prevents any accidental adjustment or release of the webbing.

Resistant and anti-chaffing

The anti-abrasion edges to the webbing prevent early wear and fraying, the soft elastomer casing isolates the deck, eliminating noise and vibrations.

Aesthetic

Lyf'Safe is an elegant solution suiting most modern deck designs.

4 models available :

- Part # 7051 : length 8,5m.
- Part # 7052 : length 11m.
- Part # 7053 : length 14m.
- Part # 7054 : length 16m.

Components of Lyf'Safe :

- 2 reflective webbings.
- 2 forged adjusters.
- 2 photoluminescent casings.
- 1 set containing 8 screws.
- 1 installation manual.



Spare parts available



Visit our **Wichard Sailing** You Tube channel and download the **Lyf'Safe** video

ProLine

When it comes to safety, compromise is not an option. That is why Wichard has developed a new generation of tethers to ensure maximum safety and ease of use thanks to some innovative new features.

Maximum safety

- ErgoLockSystem (patented): automatically closes and locks the snap hook
- Locking indicator
- Retro-reflective webbing, visible at night
- Overload indicator (as per ISAF offshore special regulations)

Uniquely easy to use

- Easy opening snap hook
- V-Nose (patented): special tip makes hooking and unhooking easy with one hand
- Wide opening snap hook (26 mm)
- Compact light tether

+ BENEFITS

- 4 models available
- Compliance with ISO 12401:2009 and ISAF regulations (OSR)
- Overload indicator with shock absorber on all models

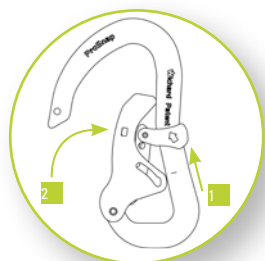

ProSnap: double action safety hook



Wide opening



V-Nose

ProSnap Safety snap hook

ProLine Webbing

ErgoLockSystem

EcoLogic

SmartLoop

| Part # | Description | Length Max | Weight Kg | |
|--------|--|--------------|-----------|--|
| 7031 | 2 ProSnap snap hooks Elastic webbing incl. overload indicator | 2 m | 0.305 | |
| 7032 | 1 ProSnap hook Flat webbing incl. overload indicator | 0.80 m | 0.150 | |
| 7033 | 1 ProSnap hook Elastic webbing incl. overload indicator | 1.40 m | 0.175 | |
| 7034 | 3 ProSnap snap hooks Elastic + flat webbing incl. overload indicator | 2 m + 1 m | 0.455 | |



Visit our **Wichard Sailing** You Tube channel and download the **Proline** video

PPE : TETHERS

ProLine'R

Releasable tether under load

The Proline'R range is equipped with a forged stainless steel snap shackle meaning they can be released under load in emergency situations (man overboard, capsizing, etc.).

The Proline'R have all the features of the Proline range: ergonomic design, wide opening, high levels of safety, lightweight structure and replaceable webbing.



| Part # | Description | Length Max | Weight Kg |
|--------|--|------------|-----------|
| 7061 | 1 ProSnap snap hook + 1 quick opening snap hook part # 2299 - elastic webbing with overload indicator | 2 m | 0.320 |
| 7064 | 2 ProSnap snap hooks + 1 quick opening snap shackle part # 2299 - elastic webbing + flat webbing - with overload indicator | 2 m + 1 m | 0.474 |

+ BENEFITS

- 2 models available
- Snap shackle on the harness can be released
- Overload indicator (OSR-Isaf) with in-built shock absorber
- CE marking

Accessories

Exclusive feature: EcoLogic

Removable snap hook lets you increase the lifespan of the product by replacing the webbing only.

Our exclusive EcoLogic feature makes ProLine a budget-friendly range!

Exclusive feature: SmartLoop

Product can adapt to suit all needs and users.

SmartLoop lets you:

- turn a single webbing tether into a double webbing tether (see fig. A)
- turn a double webbing tether into two single webbing tethers (see fig. B)

| Part # | Description |
|--------|--|
| 7041 | Proline webbing for Proline part # 7031 |
| 7042 | Proline webbing for Proline part # 7032 |
| 7043 | Proline webbing for Proline part # 7033 |
| 7071 | Proline'R webbing for Proline'R part #7061 |
| 7072 | Proline'R webbing for Proline'R part #7064 |

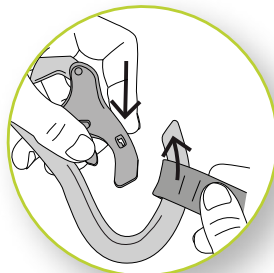

Fig A

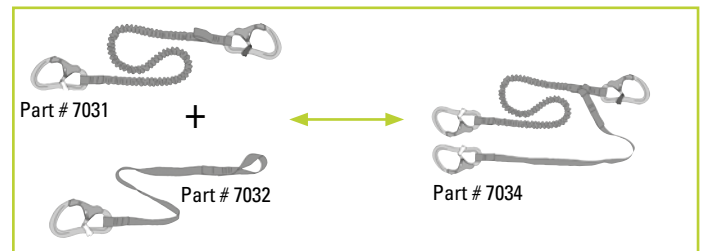
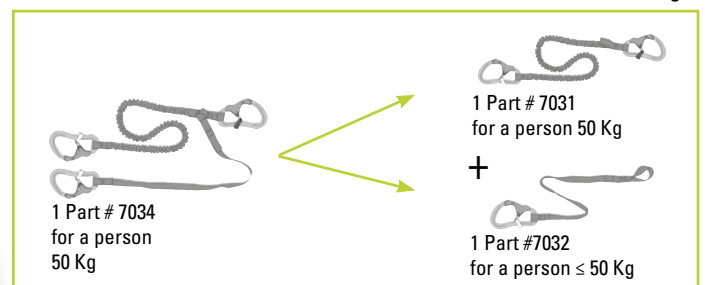

Fig B



INFORMATION ABOUT THE ISO 12401:2009 STANDARD

For the amateur sailor safety, the standard demands:

- Self-locking carabine hooks
- A possible unhooking from the harness side (for people above 50Kgs)
- An impossible unhooking from the harness side for people below 50Kgs (children)

PPE : TETHERS

+ BENEFITS

- Large range of tethers
- Compliant with ISO 12401:2009
- Available with double action safety hooks (phosphorescent) or carabiner hooks
- Available with flat or elastic tethers
- Ensures safety during movements on deck
- Designed and made in France

| N° | Part # | Description | Weight kg |
|---|--------|--|-----------|
| TETHER WITH DOUBLE ACTION SAFETY HOOKS | | | |
| 1 | 7005 | Elastic harness tether from 1 to 2 m, with double action safety hooks. | 0.398 |
| 2 | 7006 | Elastic harness tether - 1 m fixed line, the other retracts from 2 to 1 m with three double action safety hooks. | 0.582 |
| 3 | 7015 | Harness tether, 2 meter long with two double action safety hooks. | 0.392 |
| 4 | 7016 | Harness tether, flat webbing (25mm), 2 meter long with one action safety hook. | 0.210 |
| TETHERS WITH STAINLESS STEEL CARBINE HOOKS | | | |
| 5 | 7001 | Elastic harness tether from 1 to 2 m, with two stainless steel carbine hooks. | 0.418 |



+ BENEFITS

- Fitted with a quick opening snap shackle on the harness side
- With an overload indicator
- 2 models available
- Designed and made in France

| N° | Part # | Description | Weight kg |
|--------------------------------------|--------|---|-----------|
| TETHERS RELEASABLE UNDER LOAD | | | |
| 6 | 7007 | Elastic harness tether. Retracts from 2 to 1 meter, with overload indicator, one double action safety hook and one quick opening snap shackle. | 0.348 |
| 7 | 7008 | Elastic tether, 1 meter fixed line, the other retracts from 2 to 1 meter, with overload indicator, two double action safety hooks and one quick opening snap shackle. | 0.480 |





PROTECTING THE ENVIRONMENT

At Wichard, we don't simply pay lip service to environmental protection.

When manufacturing our knives, we do everything practical to contribute to protecting nature on a daily basis:

- Manufacturing our knives locally and nationally.
- Sourcing materials nationally or in Europe.
- Reducing components.
- The use of recyclable materials (for example paper from sustainably managed forests).
- Building awareness among our suppliers of the need to preserve the environment and verifying that suitable measures are being taken.

Knives

The Wichard spirit

Ever since it was founded in 1919, Wichard has produced its knives in Thiers, the traditional home of knife-making in France.

As manufacturers specialising in marine hardware, we have designed our new knife ranges to provide you with Wichard's proven strength and reliability in all circumstances during your nautical activities.

A Wichard knife is a must-have tool offering outstanding cutting performance as well as being easy to use, safe and long-lasting.

Usage

All Offshore and Aquaterra knives are fitted with a locking blade.

The shackle opener - marlinspike on the Offshore model can also be locked in the open position for improved comfort during use.

- To unlock the blade, simply press the back of the knife.
- On the Offshore models, the cut-out section on the blade allows you to open the blade one-handed. Do not use this cut-out for unshackling.

Maintenance & storage

Here are a few handy tips to ensure optimal operation and a long life for your Wichard knife:

- Wipe your knife after each use or rinse it in clear water.
- Never put your knife in the dishwasher.
- Allow it to dry with the blade open to facilitate the evaporation of water.
- After several rinses, you can apply 3 in 1 oil to the mechanism.

OFFSHORE

SAILING KNIFE STAYS SHARP IN ALL CONDITIONS

Designed for sailing and for highly demanding skippers, the «Offshore» knife offers a range of essential functions on-board a boat: Cutting quality, night visibility, locking blade, one-handed opening, corrosion resistance, mechanical resistance...

Its serrated blade enables you to easily cut all types of modern ropes including Dyneema®. The shackle opener - marlinspike version is also a vital tool on-board a sailing boat. Each Offshore knife is equipped with an adjustable wrist strap to avoid losing your knife when using it.



Serrated blade



Stainless steel blade (MA5) for an outstanding corrosion resistance



Soft grip

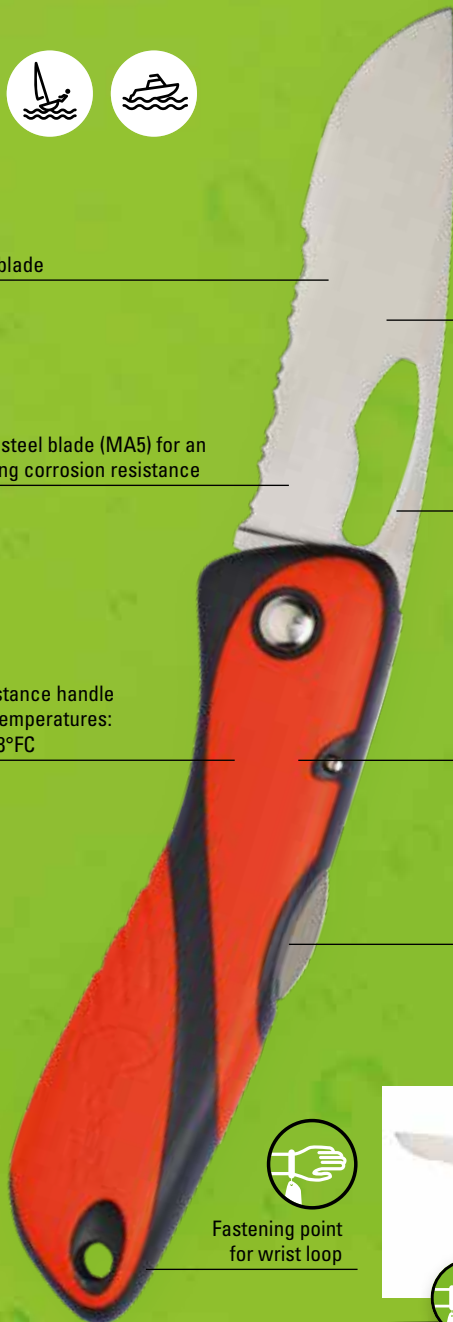

Single serrated blade version
Part # 10112 / 10116 / 10119



Remarkable cutting power



Single hand opening



Glow in the dark (depending on model)



Safety locking blade



Fastening point for wrist loop



Blade shackle key - spike

Part # 10122 / 10126 / 10129



3 colors available

OFFSHORE

| Range Part # | Single blade | Blade-shackle key - spike |
|--------------------------|---|---------------------------|
| Part # color fluorescent | 10112 | 10122 |
| Part # color blue | 10116 | 10126 |
| Part # color orange | 10119 | 10129 |
| | ✓ | ✓ |
| | ✓ | ✓ |
| | ✓ | ✓ |
| | ✓ | ✓ |
| | ✓ | ✓ |
| | ✗ | (Ø12 mm - 15/32) |
| | ✗ | ✓ |
| | ✗ | ✓ |
| | 7 ^{11/16} / 4 ^{17/32} - 195 mm / 115 mm | |
| | 3 ^{5/32} / 1 ^{25/32} - 80 mm / 45 mm | |
| | ★★★★☆ | ★★★★☆ |
| | ★★★★☆ | ★★★★☆ |
| | Part # 10112 | Part # 10122 |
| Stainless steel grade | MA5 | MA5 |
| | 66 g / 2.32 oz | 85 gr / 2.99 oz |



OFFSHORE RESCUE

Specifically developed for rescue operations and extreme sports (offshore racing, sport catamaran, white water sport, etc.). Careful material selection (N680 stainless steel grade) brings high corrosion resistance, outstanding cutting power and high robustness.



CUTTING POWER
& CORROSION RESISTANCE

RESCUE KNIFE - FIXED BLADE



Locking trigger

| OFFSHORE RESCUE | | | |
|-----------------------|----------------------------|-----------------------------|-------------------|
| | Fluorescent serrated blade | Red serrated blade | Black Plain blade |
| Part # | 10192 | 10194 | 10195 |
| | ✓ | ✓ | ✗ |
| | | ✓ | |
| | | ✓ | |
| | | ✓ | |
| | | (Ø12 mm - 15/32) | |
| | ✓ | 190 mm / 7 ^{31/64} | |
| | | 72 mm / 2 ^{53/64} | |
| | | ★★★★★ | |
| | | ★★★★★ | |
| | ✓ | | ✗ |
| Stainless steel grade | N680 | | |
| | 119g / 4.20 oz | | |

The secured sheath enables the knife to be positioned in all situations. The sheath offers many fastening points : personally on the sailor (lifejacket, arm, leg), on various locations (cockpit, steering wheel, mast foot, trampoline, catamaran cross beams).

RESCUE LINE CUTTER

The line cutter enables the cutting of small diameter lines (Dyneema lines, nets, webbings, kite lines i.e..). Thanks to a specific surface treatment, the line cutter is specially hardened (70 HRC) for better and longer cutting power.



Shackle key opener

Dia 9 mm

The secured sheath enables the knife to be positioned in all situations. The sheath offers many fastening points : personally on the sailor (lifejacket, arm, leg), on various locations (cockpit, steering wheel, mast foot, trampoline, catamaran cross beams).

OFFSHORE RESCUE

| Part # | 10193 |
|-----------------------|------------------|
| | 40 mm / 1 37/64 |
| | ✓ |
| | ✓ |
| | ✓ |
| | (Ø12 mm - 15/32) |
| | ★★★★★ |
| | ★★★★★ |
| | ✓ |
| Stainless steel grade | High hardness |
| | 80g / 2.82 oz |

AQUATERRA

YOUR SPORT KNIFE FOR ALL CONDITIONS

The AquaTerra knife is THE must-have knife for practising outdoor aquatic sports such as fishing, motor boating, kayaking or pleasure boating.

Equipped with a stainless steel blade it offers excellent cutting quality and optimal corrosion resistance. Several versions available: smooth blade or smooth blade and corkscrew. This will quickly become an essential tool for all of your sporting activities.



Plain blade



Stainless steel blade: high corrosion resistance / MA5



Remarkable cutting power

High resistance handle
Extreme temperatures:
-76°F +148°F



Soft grip



Safety locking blade



Fastening point for wrist loop



3 colors available

Single half-serrated blade model

Part # 10143 / 10144 / 10146



Plain blade with corkscrew model

Part # 10153 / 10154 / 10156

AQUATERRA

| Range Part # | Single plain blade | Plain blade with corkscrew |
|-----------------------|---|----------------------------|
| Part # color black | 10133 | 10153 |
| Part # color red | 10134 | 10154 |
| Part # color blue | 10136 | 10156 |
| | ✓ | ✓ |
| | ✗ | ✗ |
| | ✓ | ✓ |
| | ✓ | ✓ |
| | ✗ | ✓ |
| | 195 mm / 115 mm - 7 ^{19/32} / 4 ^{17/32} | |
| | 80 mm - 3 ^{5/32} | |
| | ★★★★☆ | ★★★★☆ |
| | ★★★★☆ | ★★★★☆ |
| Stainless steel grade | MA8 | MA5 |
| | 60 g - 2.11 oz | 68 g - 2.39 oz |



AQUATERRA BIO-SOURCED KNIFE

Handle nature with care

Based on castor oil resin & oyster shell powder

| Description | N° | Part | Color | Weight |
|---|----|--------------|-------------|----------|
| Smooth stainless steel blade: modified 420 HC Handle: resin made from castor oil + powdered oyster shell. Locking blade. Blade thickness: 2 mm Blade length: 80 mm Total length open/closed: 193 mm / 115 mm | 1 | Part # 10130 | Sandy brown | 0.063 kg |
| | 2 | Part # 10131 | Green | |



AQUATERRA FISHING KNIFE

LIGHT AND COMPACT

| Description | N° | Part # | Color. | Weight |
|---|----|--------|-------------|----------|
| Smooth blade - stainless steel 12C27 - Single han opening - Safety locking blade - Corkscrew - Handle with grip Blade thickness : 2mm Blade length : 80mm Total length unfolded / folded : 193mm / 115mm Handle : PA & PU | 5 | 10163 | Black/ Grey | 0.075 kg |
| | 6 | 10165 | Green/ Grey | |



CLASSIC KNIVES

Long knife with leather sheath

| | | | |
|---|--------------|---------------------------------------|----------|
| 1 | Part # 10006 | Fluorescent Length 20 cm, blade 10 cm | 0.094 kg |
| 1 | Part # 10007 | Fluorescent Length 24 cm, blade 13 cm | 0.164 kg |

Floating knife, fixed blade with sheath

| | | | |
|---|--------------|--------------------------------------|----------|
| 2 | Part # 10009 | Length 19 cm, blade 7 cm with sheath | 0.096 kg |
|---|--------------|--------------------------------------|----------|

Strap cutter

| | | | |
|---|--------------|---|----------|
| 3 | Part # 20501 | Double stainless steel blade - aluminium handle | 0.112 kg |
|---|--------------|---|----------|



AQUATERRA WOODEN-HANDLED KNIVES

| Description | N° | Part | Weight |
|--|----|-----------------------------------|----------|
| Smooth stainless steel blade: modified 420 HC. Carbon fiber & aramid tangs and handle made from olive wood. Locking blade. Blade thickness: 3 mm Blade length: 80 mm Total length: open/closed: 193 mm / 115 mm | 3 | Part # 10180 Single blade | 0.084 kg |
| | 4 | Part # 10181 Single blade / Corks | 0.094 kg |

KNIFE SHEATHS

| N° | Part# | Description | Weight |
|----|-------|--|----------|
| 1 | 10026 | Real leather sheath - For use with Offshore and Aquaterra knives - Snap fastener - Horizontal and vertical carrying - Sea water resistant sheath - colour: black | 0,024 kg |
| 2 | 10027 | Real leather sheath - For use with Offshore and Aquaterra knives - Snap fastener - Horizontal and vertical carrying - Sea water resistant sheath - colour: brown | 0,024 kg |
| 3 | 10022 | Cordura® sheath - For use with Offshore and Aquaterra knives - Velcro® strap - Horizontal and vertical carrying - Colour: black | 0.022 kg |
| 4 | 10028 | Sheath for Offshore Rescue knife (part.#10192) Many fastening points - Glows in the dark | 0.030 kg |
| 5 | 10029 | Sheath for Offshore Rescue Line cutter (part.#10193) - Many fastening points - Colour : black | 0.020 kg |





Sailing accessories

Tiller extensions, accessories

Wichard designs products which aim at easing the operations and the life on board. They will quickly become essential tools.

Tiller extensions

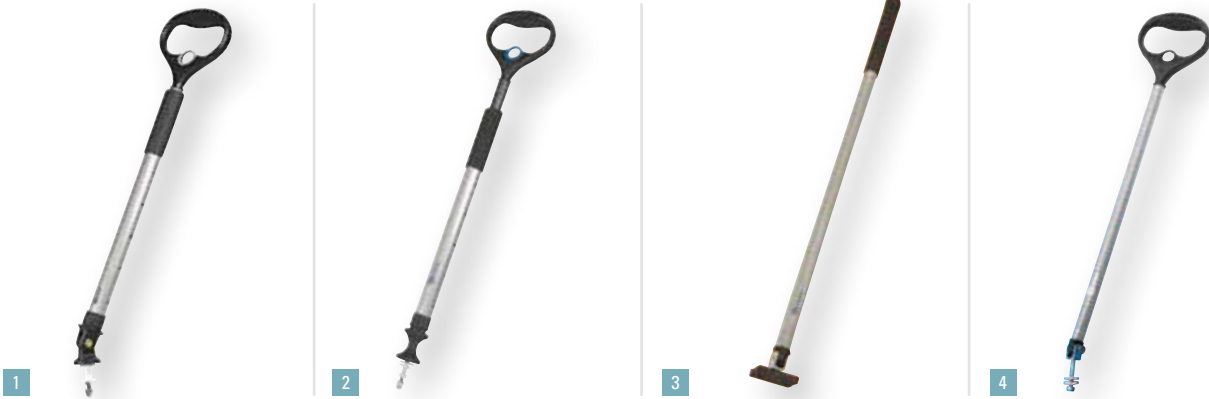

+ BENEFITS

- Large range of tiller extensions
- With or without handle, telescopic or fixed models
- Telescopic models with ball-locking system
- Different joint systems available
- Ergonomic non-slip handles



| N° | Part # | Description | Weight kg |
|--------------------------------------|--------|--|-----------|
| TELESCOPIC TILLER EXTENSIONS | | | |
| 1 | 7550 | Adjustable from 70 to 100 cm | 0.682 |
| 1 | 7551 | Adjustable from 80 to 120 cm | 0.716 |
| 2 | 7555 | Adjustable from 70 to 100 cm, stand up rubber articulation | 0.708 |
| 2 | 7556 | Adjustable from 80 to 120 cm, stand up rubber articulation | 0.798 |
| TILLER EXTENSIONS | | | |
| 3 | 7510 | Length 70 cm - universal ball joint | 0.310 |
| 3 | 7520 | Length 95 cm - universal ball joint | 0.406 |
| TILLER EXTENSIONS WITH HANDLE | | | |
| 4 | 7540 | Non retractable - length 58 cm | 0.378 |
| 4 | 7541 | Non retractable - length 70 cm | 0.406 |
| RETAINING CLIPS | | | |
| 5 | 7500 | Retaining clips for parts # 7510, 7520, 7540, 7541 (tube dia. 20 mm) | 0.015 |
| 6 | 7501 | Retaining clips for parts # 7550, 7551, 7555, 7556 (tube dia. 30 mm) | 0.012 |
| SPARE ARTICULATIONS | | | |
| 7 | 7504 | Spare articulation for parts # 7540, 7541 | 0,076 |
| 8 | 7505 | Spare articulation for parts # 7555 | 0.146 |
| 8 | 7506 | Spare articulation for parts # 7556 | 0.162 |
| 9 | 7507 | Spare articulation for parts # 7550, 7551 | 0.168 |
| 10 | 7502 | Spare articulation for parts # 7510, 7520 | 0.080 |



FORTRESS ANCHORS

Wichard offers the range of Fortress anchors for boats from 8 to 21m. The main benefits are: Outstanding holding power, light weight, adjustable fluke angles, easy dismantling and easy handling by any crew member.

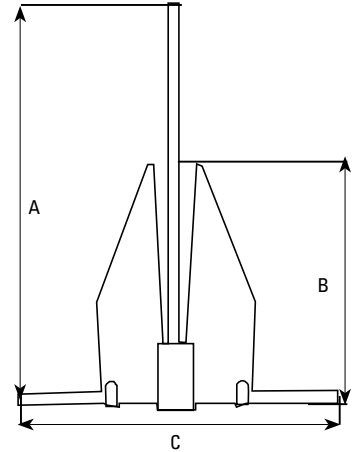

| Boat Length m | -8 | from 8 to 10 | from 10 to 12 | from 12 to 14 | from 14 to 15,5m | from 15,5 to 18 | from 18 to 21 | 21 |
|---------------------|-----|--------------|---------------|---------------|------------------|-----------------|---------------|-------|
| Fortress models | FX7 | FX11 | FX16 | FX23 | FX37 | FX55 | FX85 | FX125 |
| Working load Kg | 315 | 400 | 560 | 900 | 1350 | 1800 | 2350 | 3040 |
| Weight Kg | 2,5 | 2,9 | 4,3 | 6,6 | 10 | 15 | 21 | 30 |
| Shank length mm (A) | 610 | 686 | 787 | 914 | 1016 | 1168 | 1295 | 1422 |
| Fluke length mm (B) | 356 | 406 | 457 | 533 | 610 | 686 | 762 | 838 |
| Stock length mm (C) | 483 | 559 | 635 | 737 | 813 | 940 | 1041 | 1143 |
| Shackle dia mm | 6 | 6 | 8 | 10 | 12 | 12 | 16 | 16 |

Supplementary products

Snap hooks Plastic

| N° | Part # | Description |
|-----------------------------------|---------|--|
| SNAP HOOKS - PLASTIC - POM | | |
| 1 | MQ00372 | Snap hook - size 1 - L: 37 mm - Breaking load: 40 Kg 0.002 kg |
| 2 | MQ00502 | Snap hook - size 1 - L: 50 mm - Breaking load: 30 Kg 0.003 kg |
| 3 | MQ00752 | Snap hook - size 1 - L: 75 mm - Breaking load: 50 Kg 0.010 kg |
| 4 | MQ1002 | Snap hook - size 1 - L: 100 mm - Breaking load: 70 Kg 0.031 kg |
| 5 | MD00642 | Snap hook - size 1 - L: 64 mm - Breaking load: 20 Kg 0.003 kg |



Fairleads



Wichard offers now a complete range of fairleads dedicated to the deviation of furling lines such as ropes for manual-headsail or flying-sail furlers..

| N° | Part # | Description | Weight kg |
|----|--------|---|-----------|
| 1 | 20120 | Stainless steel single fairlead - For 25mm stanchion Maximum line diameter : 20mm | 0.080 |
| 2 | 21020 | Stainless steel deck fairlead - M10 screw Maximum line diameter : 18 mm | 0.108 |
| 3 | 20220 | Stainless steel double fairlead with Velcro stripe for continuous line. For 25mm stanchion maximum - Maximum line diameter : 20 mm | 0.180 |
| 3 | 21220 | Stainless steel double fairlead with Velcro stripe for continuous line. For 28mm stanchion maximum - Maximum line diameter : 20 mm | 0.225 |
| 4 | 21120 | Stainless steel articulated fairlead - For 25 & 28mm stanchion maximum - Maximum line diameter : 20 mm | 0.110 |
| 5 | 20320 | Deck fairlead - Fitting with 2 M5 screws Max rope size : 18 mm - Duplex stainless steel grade | 0.063 |



1



2



3



4



5

Anti-torque cable clamps

| Part # | Cable size mm | A mm | B mm | L mm | Weight kg |
|--------|---------------|------|------|------|-----------|
| 7321 | 9 | 8.5 | 29 | 56 | 0.169 |
| 7322 | 11 | 10 | 31 | 60 | 0.198 |
| 7323 | 13 | 12 | 35 | 62 | 0.243 |
| 7324 | 15 | 15 | 40 | 100 | 0.525 |

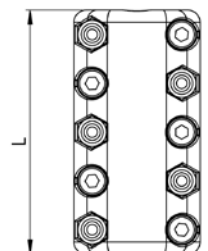
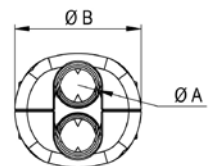

+ BENEFITS

- For anti-torque cables : dia 9, 11, 13 and 15 mm
- Can be used for gennaker with Marlow ProDrive +
- Can be used for asymmetric spinnakers with most of the anti-torque cables available on the market
- Material : Duplex stainless steel grade

STANDARD

| Part # | Size mm | Dimensions | | | | | | | Weight g | WLL kg | BL kg |
|---------|---------|------------|-------|------|------|------|------|-----|----------|--------|-------|
| | | L.T. | L.I. | A | O | E | T | | | | |
| 25N | 2,5 | 26,0 | 21,0 | 7,0 | 3,5 | 8,0 | 3,5 | 3 | 100 | 500 | |
| 30N | 3,0 | 31,0 | 25,0 | 8,5 | 4,0 | 9,0 | 4,0 | 5 | 160 | 800 | |
| 35N | 3,5 | 36,0 | 29,0 | 10,0 | 5,0 | 11,0 | 5,0 | 8 | 220 | 1100 | |
| 40N | 4,0 | 39,5 | 31,5 | 11,5 | 5,5 | 12,5 | 6,0 | 12 | 280 | 1400 | |
| 50N | 5,0 | 49,5 | 39,5 | 13,0 | 6,5 | 16,0 | 7,0 | 21 | 450 | 2250 | |
| 60N | 6,0 | 57,0 | 45,0 | 14,5 | 7,5 | 19,0 | 9,0 | 35 | 650 | 3250 | |
| 70N | 7,0 | 66,0 | 52,0 | 16,0 | 8,5 | 21,5 | 10,0 | 52 | 900 | 4500 | |
| 70N EN | 7,0 | 66,0 | 52,0 | 16,0 | 8,5 | 21,5 | 10,0 | 52 | - | 45 kN | |
| 80N | 8,0 | 74,0 | 58,0 | 17,5 | 11,0 | 24,0 | 11,0 | 79 | 1100 | 5500 | |
| 80N EN | 8,0 | 74,0 | 58,0 | 17,5 | 11,0 | 24,0 | 11,0 | 79 | - | 55 kN | |
| 90N | 9,0 | 80,0 | 62,0 | 19,0 | 11,0 | 26,0 | 12,0 | 105 | 1400 | 7000 | |
| 100N | 10,0 | 89,0 | 69,0 | 20,5 | 12,0 | 29,0 | 13,0 | 141 | 1800 | 9000 | |
| 100N EN | 10,0 | 89,0 | 69,0 | 20,5 | 12,0 | 29,0 | 13,0 | 141 | - | 90 kN | |
| 120N | 12,0 | 104,5 | 80,5 | 23,5 | 15,0 | 33,0 | 15,0 | 238 | 2500 | 12500 | |
| 140N | 14,0 | 121,0 | 93,0 | 26,5 | 17,0 | 38,5 | 17,0 | 374 | 3500 | 17500 | |
| 160N | 16,0 | 140,0 | 108,0 | 29,5 | 19,0 | 45,0 | 19,0 | 576 | 4500 | 22500 | |

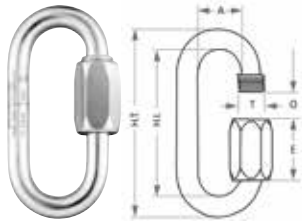

LARGE OPENING

| Part # | Size mm | Dimensions | | | | | | | Weight g | WLL kg | BL kg |
|---------|---------|------------|-------|------|------|------|------|-----|----------|--------|-------|
| | | L.T. | L.I. | A | O | E | T | | | | |
| 25GO | 2,5 | 33,0 | 28,0 | 7,0 | 7,0 | 12,0 | 3,5 | 4 | 90 | 450 | |
| 30GO | 3,0 | 39,5 | 33,5 | 8,5 | 8,5 | 13,5 | 4,0 | 7 | 145 | 725 | |
| 35GO | 3,5 | 46,0 | 39,0 | 10,0 | 10,0 | 16,0 | 5,0 | 11 | 200 | 1000 | |
| 40GO | 4,0 | 53,0 | 45,0 | 11,5 | 11,5 | 19,0 | 6,0 | 15 | 250 | 1250 | |
| 50GO | 5,0 | 62,0 | 52,0 | 13,0 | 13,0 | 22,0 | 7,0 | 26 | 400 | 2000 | |
| 60GO | 6,0 | 70,5 | 58,5 | 14,5 | 14,5 | 25,0 | 9,0 | 42 | 580 | 2900 | |
| 70GO | 7,0 | 79,0 | 65,0 | 16,0 | 16,0 | 28,0 | 10,0 | 62 | 800 | 4000 | |
| 70GO EN | 7,0 | 79,0 | 65,0 | 16,0 | 16,0 | 28,0 | 10,0 | 62 | - | 40 kN | |
| 80GO | 8,0 | 88,0 | 72,0 | 17,5 | 17,5 | 31,5 | 11,0 | 93 | 980 | 4900 | |
| 90GO | 9,0 | 95,0 | 77,0 | 19,0 | 19,0 | 33,0 | 12,0 | 121 | 1250 | 6250 | |
| 100GO | 10,0 | 105,5 | 85,5 | 20,5 | 20,5 | 36,0 | 13,0 | 161 | 1600 | 8000 | |
| 120GO | 12,0 | 124,0 | 100,0 | 23,5 | 23,5 | 43,0 | 15,0 | 275 | 2200 | 11000 | |
| 140GO | 14,0 | 142,0 | 114,0 | 26,5 | 26,5 | 49,0 | 17,0 | 431 | 3100 | 15500 | |
| 160GO | 16,0 | 161,0 | 129,0 | 29,5 | 29,5 | 54,0 | 19,0 | 646 | 4000 | 20000 | |

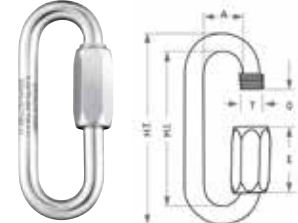

DELTA

| Part # | Size mm | Dimensions | | | | | | | | | | Weight g | WLL Kg | BL Kg |
|--------|---------|------------|-------|-------|-------|-------|------|------|-------|------|-----|----------|--------|-------|
| | | L.T. | L.I.1 | L.I.2 | H.T | H.I | O | E | R | T | | | | |
| 25D | 2,5 | 22,0 | 10,0 | 17,0 | 27,0 | 22,0 | 3,5 | 8,0 | 3,50 | 3,5 | 3 | 70 | 350 | |
| 30D | 3,0 | 27,0 | 12,5 | 21,0 | 30,0 | 24,0 | 4,0 | 9,0 | 4,25 | 4,0 | 6 | 110 | 550 | |
| 35D | 3,5 | 31,0 | 14,0 | 24,0 | 36,0 | 29,0 | 5,0 | 11,0 | 5,00 | 5,0 | 10 | 150 | 750 | |
| 40D | 4,0 | 35,5 | 16,0 | 27,5 | 40,0 | 32,0 | 5,5 | 12,5 | 5,75 | 6,0 | 14 | 200 | 1000 | |
| 50D | 5,0 | 40,0 | 17,0 | 30,0 | 48,0 | 38,0 | 6,5 | 16,0 | 6,50 | 7,0 | 24 | 325 | 1625 | |
| 60D | 6,0 | 47,0 | 20,5 | 35,0 | 56,0 | 44,0 | 7,5 | 19,0 | 7,25 | 8,0 | 40 | 450 | 2250 | |
| 70D | 7,0 | 51,0 | 21,0 | 37,0 | 63,0 | 49,0 | 8,5 | 21,5 | 8,00 | 10,0 | 59 | 625 | 3125 | |
| 70D EN | 7,0 | 51,0 | 21,0 | 37,0 | 63,0 | 49,0 | 8,5 | 21,5 | 8,00 | 10,0 | 59 | - | 31 kN | |
| 80D | 8,0 | 56,0 | 22,5 | 40,0 | 73,0 | 57,0 | 10,0 | 24,0 | 8,85 | 11,0 | 88 | 770 | 3850 | |
| 90D | 9,0 | 60,0 | 23,0 | 42,0 | 78,0 | 60,0 | 11,0 | 26,0 | 9,50 | 12,0 | 115 | 980 | 4900 | |
| 100D | 10,0 | 66,0 | 25,5 | 46,0 | 87,0 | 67,0 | 12,0 | 29,0 | 10,25 | 13,0 | 156 | 1250 | 6250 | |
| 120D | 12,0 | 75,0 | 27,5 | 51,0 | 104,0 | 80,0 | 15,0 | 33,0 | 11,75 | 15,0 | 262 | 1750 | 8750 | |
| 140D | 14,0 | 85,0 | 30,5 | 57,0 | 123,0 | 95,0 | 17,0 | 38,5 | 13,25 | 17,0 | 414 | 2450 | 12250 | |
| 160D | 16,0 | 93,0 | 31,5 | 61,0 | 138,0 | 106,0 | 19,0 | 45,0 | 14,75 | 19,0 | 627 | 3150 | 15750 | |

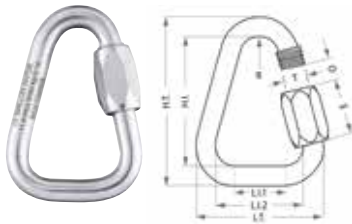

PEAR

| Part # | Size mm | Dimensions | | | | | | | | | | Weight g | WLL Kg | BL Kg |
|--------|---------|------------|------|-------|-------|------|------|------|------|------|-----|----------|--------|-------|
| | | L.T. | L.I. | H.T | H.I | O | E | R1 | R2 | T | | | | |
| 25P | 2,5 | 20,0 | 15,0 | 40,0 | 35,0 | 7,0 | 12,0 | 3,5 | 7,5 | 3,5 | 5 | 60 | 300 | |
| 30P | 3,0 | 23,6 | 17,6 | 45,5 | 39,5 | 8,5 | 13,5 | 4,3 | 8,8 | 4,0 | 8 | 100 | 500 | |
| 35P | 3,5 | 27,6 | 20,6 | 52,7 | 45,7 | 10,0 | 16,0 | 5,0 | 10,3 | 5,0 | 12 | 130 | 650 | |
| 40P | 4,0 | 31,8 | 23,8 | 61,2 | 53,2 | 11,5 | 19,0 | 5,8 | 11,9 | 6,0 | 18 | 170 | 850 | |
| 50P | 5,0 | 37,1 | 27,1 | 70,7 | 60,7 | 13,0 | 22,0 | 6,5 | 13,6 | 7,0 | 30 | 270 | 1350 | |
| 60P | 6,0 | 42,7 | 30,7 | 81,3 | 69,3 | 14,5 | 25,0 | 7,3 | 15,4 | 9,0 | 50 | 400 | 2000 | |
| 70P | 7,0 | 48,0 | 34,0 | 90,8 | 76,8 | 16,0 | 28,0 | 8,0 | 17,0 | 10,0 | 73 | 550 | 2750 | |
| 80P | 8,0 | 53,2 | 37,2 | 100,2 | 84,2 | 17,5 | 31,5 | 8,8 | 18,6 | 11,0 | 108 | 660 | 3300 | |
| 90P | 9,0 | 58,0 | 40,0 | 107,9 | 89,9 | 19,0 | 33,0 | 9,5 | 20,0 | 12,0 | 142 | 840 | 4200 | |
| 100P | 10,0 | 63,4 | 43,4 | 118,0 | 98,0 | 20,5 | 36,0 | 10,3 | 21,7 | 13,0 | 187 | 1100 | 5500 | |
| 120P | 12,0 | 76,0 | 52,0 | 144,0 | 120,0 | 23,5 | 43,0 | 11,8 | 26,0 | 15,0 | 329 | 1500 | 7500 | |
| 140P | 14,0 | 85,0 | 57,0 | 157,6 | 129,6 | 26,5 | 49,0 | 13,3 | 28,5 | 17,0 | 492 | 2100 | 10500 | |
| 160P | 16,0 | 95,5 | 63,5 | 176,5 | 144,5 | 29,5 | 54,0 | 14,8 | 31,8 | 19,0 | 735 | 2700 | 13500 | |



SQUARE

| Part # | Size mm | Dimensions | | | | | | | Weight g | WLL kg | BL kg | |
|--------|---------|------------|-------|-------|-------|-------|------|------|----------|--------|-------|-------|
| | | L.T. | L.I.1 | L.I.2 | H.T | H.I | O | E | | | | T |
| 25C | 2,5 | 22,0 | 10,0 | 17,0 | 26,0 | 21,0 | 3,5 | 8,0 | 3,5 | 4 | 70 | 350 |
| 30C | 3,0 | 24,0 | 9,5 | 18,0 | 31,0 | 25,0 | 4,0 | 9,0 | 4,0 | 6 | 110 | 550 |
| 35C | 3,5 | 29,0 | 12,0 | 22,0 | 36,0 | 29,0 | 5,0 | 11,0 | 5,0 | 11 | 150 | 750 |
| 40C | 4,0 | 33,0 | 13,5 | 25,0 | 41,0 | 33,0 | 5,5 | 12,5 | 6,0 | 15 | 200 | 1000 |
| 50C | 5,0 | 38,0 | 15,0 | 28,0 | 50,0 | 40,0 | 6,5 | 16,0 | 7,0 | 27 | 325 | 1625 |
| 60C | 6,0 | 43,0 | 16,5 | 31,0 | 57,0 | 45,0 | 7,5 | 19,0 | 9,0 | 44 | 450 | 2250 |
| 70C | 7,0 | 48,0 | 18,0 | 34,0 | 66,0 | 52,0 | 8,5 | 21,5 | 10,0 | 66 | 625 | 3125 |
| 80C | 8,0 | 53,0 | 19,5 | 37,0 | 76,0 | 60,0 | 10,0 | 24,0 | 11,0 | 90 | 770 | 3850 |
| 90C | 9,0 | 58,0 | 21,0 | 40,0 | 83,0 | 65,0 | 11,0 | 26,0 | 12,0 | 132 | 980 | 4900 |
| 100C | 10,0 | 63,0 | 22,5 | 43,0 | 92,0 | 72,0 | 12,0 | 29,0 | 13,0 | 171 | 1250 | 6250 |
| 120C | 12,0 | 74,0 | 26,5 | 50,0 | 109,0 | 85,0 | 15,0 | 33,0 | 15,0 | 285 | 1750 | 8750 |
| 140C | 14,0 | 85,0 | 30,5 | 57,0 | 124,0 | 96,0 | 17,0 | 38,5 | 17,0 | 451 | 2450 | 12250 |
| 160C | 16,0 | 96,0 | 34,5 | 64,0 | 142,0 | 110,0 | 19,0 | 45,0 | 19,0 | 700 | 3150 | 15750 |

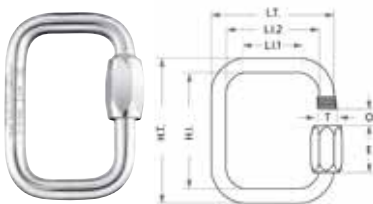

BETA PIN

| Part # | Size mm | Dimensions | | | | | Weight g |
|--------|---------|------------|------|----------|----|--|----------|
| | | L | H | Dia axis | | | |
| 20GB | 2,0 | 48,0 | 15,0 | 8 to 12 | 3 | | |
| 25GB | 2,5 | 53,0 | 18,0 | 8 to 14 | 4 | | |
| 30GB | 3,0 | 60,0 | 21,0 | 10 to 15 | 8 | | |
| 40GB | 4,0 | 78,0 | 28,0 | 15 to 20 | 16 | | |
| 45GB | 4,5 | 102,0 | 34,0 | 20 to 22 | 27 | | |
| 50GB | 5,0 | 103,0 | 34,0 | 20 to 25 | 33 | | |
| 60GB | 6,0 | 103,0 | 36,0 | 25 to 30 | 52 | | |

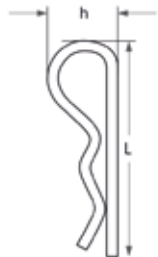

LINCHPIN

| Part # | Size mm | | | | Dimension | | | | | | | | Weight g |
|--------|---------|-----|-----|------|-----------|-----|------|-----|------|------|------|-----------|----------|
| | D1 | D2 | D3 | D4 | B1 | B2 | B3 | A | H | L1 | L2 | DIN 11023 | |
| 45GC | 4,5 | 2,7 | 2,5 | 25,0 | 10,5 | 3,6 | 35,0 | 4,5 | 7,0 | 32,0 | 51,0 | 5 x 32 | 10 |
| 75GC | 7,5 | 4,0 | 3,6 | 32,0 | 13,5 | 7,5 | 50,0 | 7,5 | 7,0 | 42,0 | 62,0 | 8 x 42 | 36 |
| 105GC | 10,5 | 4,5 | 3,6 | 32,0 | 14,0 | 8,0 | 50,0 | 8,5 | 11,0 | 45,0 | 66,0 | 12 x 45 | 50 |

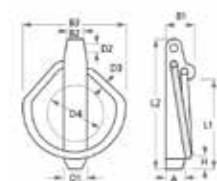

Technical information

Warranty

All Wichard products are warranted to be free of defects in materials or workmanship for five (5) years from the date of purchase by the original end-user. Excluded from this warranty are:

- Any product which has been improperly fitted.
- Any product which has been improperly used or used in any application for which it was not intended.
- Any product which has been improperly maintained.
- Any product modified without a written approval from Wichard.
- Any damage being a consequence from alteration, from ultraviolet light exposure or from the normal wear of products.

The useful life of any products is determined by its utilisation and an appropriate factor of safety (see page 67). It must be distinctly assessed in each application. Thus no guarantee can be provided for product life, dynamic capacities or any other factor due to the variability in usage.

Wichard's liability is limited to the repair or replacement of the defective goods exclusive of any other repair. Responsibility and costs of handling, transportation and any custom duties and tariffs linked to the warranty claim are in any case borne by Wichard.

Corrosion in marine environment

All Wichard products are passivated. Corrosion attacks stainless steel and is always visible in the form of black coloured roughness. Although this is dangerous, it is rarely seen in current use, except in cases where martensitic (HR) steel is in total, prolonged immersion. What many people erroneously call corrosion, is really rust, or oxidation. This is due to outside causes. In the marine environment, stainless steel is subject to considerable aggressive forces and is not totally corrosion free. Re-passivation can be accomplished with a passivator such as Wichinox (see page 8). All stainless steel products demand a minimum of upkeep.

Stainless steel

Wichard uses top-quality grades of stainless steel in its products (see chart). The first type is a low carbon austenitic steel (316L), which offers good mechanical characteristics. They are non-magnetic steels and most of Wichard products are manufactured in this grade. The second (17.4PH) is martensitic steel (magnetic), which is referred to as high-resistance steel (HR).

| Type | Austenitic | Martensitic |
|---------------------------|-----------------|-----------------|
| Common name | 18.12 Mo | 17.4 PH |
| European Standard | X2CrNiMo17-12-2 | X5CrNiCuNb 16-4 |
| US AISI Standard | 316 L | 630 |
| Composition Carbon | < 0,03 % | < 0,07 % |
| Chromium | 18 % | 16,5 % |
| Nickel | 12 % | 4 % |
| Molybdenum | 3 % | |
| Copper | | 4 % |

Why a Wichard shackle?

A Wichard shackle is manufactured on a very old principal, forging. Wichard has perfected and machined this process down to the smallest detail.

Reliability and high quality

After the raw metal bars are checked on chemical alloy and quality, the metal is heated to the right temperature to be forged. Then the metal is pressed in its new shape with great force by a hydraulic hammer. Due to this process the metal obtains an organized structure without any weakness. Because of this structure, called fibers, the metal object is not only very strong but also has an "elastic" property.

Casted metal objects of the same design are less strong because the structure in the metal is not the same everywhere in the object. Next to this there is the chance that small air bubbles are enclosed during the casting. This causes a capital weakness in the casted object. Even objects machined from a block of metal can have weaknesses. Where the metal is machined into a curve the structure in the metal is broken and becomes a weak point in the object. When the object is overloaded it will break at this point.

Performance and security

Due to the technique of forging every object of the same design and shape has the same properties with a small tolerance of deviation. By controlling all important factors Wichard can guarantee an accurate breaking load and working load for each individual object.

Wichard advises to respect carefully the Working Load (WL) indicated for each of its products. If a Wichard product is overloaded between the safe working load and breaking load the product will deform due to its "elastic" property. This gives the user an extra safety margin and shows when the product is overloaded. Deformed parts have to be replaced immediately preferably by a part in a larger size.

Definitions

Working Load (WL) indicates the value of static load at which the product will still function without excessive friction or wear or permanent deformation of components.

Breaking Load (BL) indicates the value of static load for which a major failure of one or some structural components or the complete destruction of the product can be expected when new. Plastic components may split, rivets may give way, shackles or any other connection parts break and other metallic components may fracture.

Units of load

Our resistance values are shown in kilogramme-force (symbol: kgf or more usually kg), which is the force due to gravity sustained by a mass of 1 kg situated at the latitude of Paris. This unit of force is obsolete, and is not part of the SI international system of units, which links concepts of mass and weight. The unit of force used in the SI system is the Newton (N).

To pass from the kilogramme-force to the Newton its value must be multiplied by g, the acceleration of gravity, which is 9.80665 m/sec² at the latitude of Paris, or 9.80665 N (N = kg x m x s⁻²). In the fields where the kgf appears we should now use the decanewton (or dekanewton), daN: 1 kgf = 9.806 65 N = 0.980665 daN (1 daN = 1.019 716 kgf).

Our test equipment measures loads in daN, but bowing to custom and for reasons of simplicity and safety, we still give values in kgs in our brochures and on our products. Our measured values have simply been converted into kgs.

Factor of safety

Before choosing or specifying a particular product, an appropriate factor of safety should be applied to Breaking Loads (BL) to suit each application.

For many industrial and safety applications, and for some yachting application, a factor of safety greater than two (2) should be used or may be required by law or other regulations. It is the customer's responsibility to ensure that an appropriate factor of safety is used, and it should take into account safety implications, service life, fatigue (as may be caused by wave action, wind stress or repetitive cyclical loading), type of load, exposure to ultraviolet light, corrosion and stress corrosion (such as in high humidity or high chlorine environment). Even more attention is required when specifying blocks as other factors have to be taken into account such as rotary speed, deflection angle of the rope or the number of wire of the tackle (see page 31 of the present document). Note that a "Safe Working Load" is not specified as this is dependent on the factor of safety, which must be determined by the user relative to each application.

In any case, never use the products over the working load !

Useful life

The useful life of any products is determined by the above factors and must be assessed in each application. Thus no guarantee can be provided for product life, dynamic capacities or any other factor due to the variability in usage. In some jurisdictions government regulations require the replacement of rigging components within certain periods of time, usually after three or five years. You must ascertain whether any such regulations affect you and take appropriate steps if you are affected.

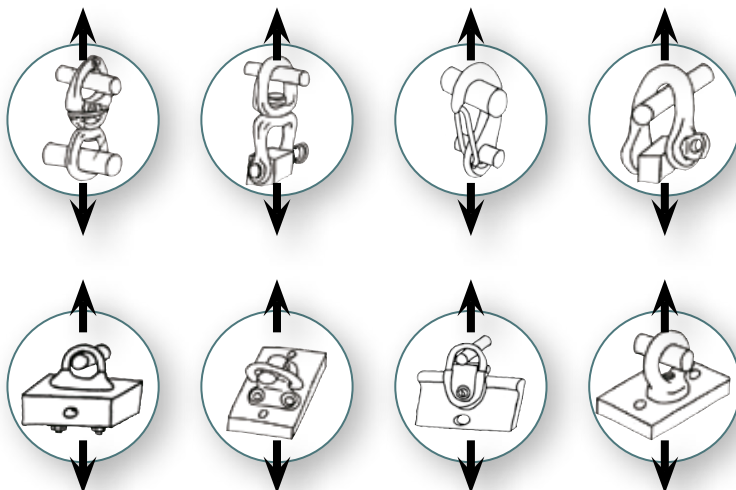

Maintenance and inspection

All your marine hardware, blocks and equipments must receive regular inspections to prevent any deformation, wear, cracks or corrosion. Even if your products have had little use, ultraviolet light exposure, wave action, humid or saline environment may cause damage that could affect quality or strength of the equipment. If, after inspection, you are in doubt about the integrity of one of some parts, it is the customer's responsibility to replace the defective components or product to ensure his own safety.

While every precaution is taken in the product design and manufacturing processes of our products to minimize the effects of corrosion or stress corrosion, appropriate preventive or corrective treatments must be carried out to the products after installation.

Contact

Refer to the distributor list on our website: www.wichard.com

| Country | Company | Zip code | City | Area code | Phone | E-mail |
|------------------|------------------------------|-----------|---------------------|-----------|-------------------|------------------------------|
| Austria | Alltechnik | 2362 | Biedermannsdorf | 43 | 2 23 664 676 | office@allroundmarin.com |
| Austria | Robert Lindemann KG | 20537 | Hamburg | 49 | 40 211 197-0 | info@lindemann-kg.de |
| Belgium | Plaisance Diffusion | 1030 | Brussels | 32 | 0 2 216 79 34 | info@plaisance.be |
| Belgium | Technique Voile | 4432 | Alleur | 32 | 0 42 63 4041 | info@technique-voile.be |
| Belgium | West Diep Yachting Center | 8620 | Nieuwpoort | 32 | 58 234 061 | info@westdiep.com |
| Belgium | Wittevrongel Sail | 8370 | Blankenberge | 32 | 50 411 863 | ian@wittevrongel.be |
| Belgium | Wittevrongel Rigging | 8370 | Blankenberge | 32 | 0 49 62 8 45 76 | steve@wittevrongel.be |
| Belgium | Seashop | 8620 | Nieuwpoort | 32 | 0 58 62 50 77 | info@seashop.be |
| Belgium | La Corderie | 1050 | Brussels | 32 | 0 26 40 72 47 | seb@cordage.be |
| Brazil | Rio Sail Tech | 22290-240 | Rio de Janeiro | 55 | 254 202 33 | contato@riosailtech.com.br |
| Canada | WPG Canada | J0B 3G0 | Stoke (Quebec) | 1 | 819 878 30 18 | info@wichard.ca |
| Canary Islands | Nordest | 38001 | Santa Cruz Tenerife | 34 | 9 22 577 322 | nordest@nordest-canarias.com |
| China | Sunrise Marineware Ltd | | Shenzhen | 86 | 755 866 50 101 | sales@sunrisemw.com |
| Croatia | Aspar - Rigging | 51 000 | Rijeka | 385 | 51 343 230 | aspar-rigging@ri.t-com.hr |
| Denmark | Columbus Marine | 4621 | Gadstrup | 45 | 46 19 11 66 | columbus@columbus-marine.dk |
| Finland | Oy Maritim AB | 00210 | Helsinki | 358 | 10 2740 320 | maritim@maritim.fi |
| French Polynesia | Tahiti Sport/Nauti Sport | 98713 | Papeete | 689 | 50 59 59 | tahiti.sport@tahiti-sport.pf |
| Germany | Robert Lindemann KG | 20537 | Hamburg | 49 | 40 211 197-0 | info@lindemann-kg.de |
| Greece | Tecrep Marine | 18536 | Piraeus | 30 | 14 521 647 | sales@tecrepmarine.gr |
| Greece | Theodosiadis Kiriakkos | 18545 | Piraeus | 30 | 21 04 205 890 | info@theodosiadis.gr |
| Greece | Nautilus | 17455 | Alimos / Athènes | 30 | 21 09 854 238 | info@nautilus.gr |
| Greece | Synodinos | 18545 | Piraeus | 30 | 21 04 17 07 09 | info@synodinos.gr |
| Hong Kong | Storm Force Marine Ltd | | Hong Kong | 852 | 2866-0114 | sales@stormforcemarine.com |
| Hungary | Marina Yacht Sport Kft | 1078 | Budapest | 361 | 3 228 655 | bolt@marina.hu |
| Italy | C-Marine S.r.l. | 19031 | Bocca di Magra - SP | 39 | 0187 67 08 28 | info@cmarine.it |
| Japan | Marine Services Kojima | 236-0003 | Kanagawa | 81 | 4 57 903 581 | toiawase@mskojima.co.jp |
| Malta | Gauci Borda & Co Ltd | GZR03 | Gzira | 356 | 2131 3758/3748 | info@gauciborda.com |
| Netherlands | On Deck BV | 2156 MX | Weteringbrug | 31 | 71 331 33 66 | allhands@on-deck.nl |
| New Caledonia | Marine Corail | 98845 | Nouméa | 687 | 27 58 48 | info@marine-corail.nc |
| New Caledonia | Boniface ACMA | 98863 | Nouméa | 687 | 28 28 10 | vente@acma.nc |
| New Zealand | Kiwi Yachting | 90114 | Auckland | 64 | 9 36 00 30 0 | sales@kiwiyachting.co.nz |
| Norway | Hovdan-Poly A/S | 0614 | Oslo | 47 | 23 14 12 60 | post@hovdan.no |
| Poland | Majer Na Fali | 01-971 | Warsaw | 48 | 533 655 095 | office@majernafali.pl |
| Portugal | Luiz Godinho | 1400-287 | Lisbon | 351 | 2 13 017 753 | luizgodinho@iol.pt |
| Portugal | Lisnautica Lda | 1300-340 | Lisbon | 351 | 213 639 084 | lisnautica@gmail.com |
| Portugal | DND Lda | 1300-598 | Lisbon | 351 | 351 213 619 530 | dnd@dnd.pt |
| Portugal | Peter Keeping Unipessoal Lda | 8800-166 | Tavira | 351 | 281 971 179 | info@just-boats.net |
| Russia | Fordewind-Regatta Ltd | 197110 | St Petersburg | 7 | 8 124 584 455 | office@fordewind-regatta.ru |
| Singapore | Intermarine Supply Co | 639078 | Jurong | 65 | 68 633 966 | admin@intermarine.com.sg |
| South Africa | Manex & Power Marine | 7420 | Paarden Eiland | 27 | 021-511 7292 | manex@manex.co.za |
| Spain | Flint Suministros S.L. | 46200 | Valencia | 34 | 962 542 088 | info@flint.es |
| Sweden | Liros Skandinavia AB | 42750 | Billdal | 46 | 31 91 52 00 | info@lirosropes.se |
| Switzerland | Bucher & Walt SA | 2072 | St Blaise | 41 | 3 27 559 500 | info@bucher-walt.ch |
| Thailand | Sail in Siam Co Ltd | 20250 | Chonburi | 66 | 818 375 507 | info@sailinsiam.com |
| Turkey | Marintek | 34700 | Istanbul | 90 | 2 163 171 010 | info@marintek.com.tr |
| Turkey | UTL - Skiper | 34450 | Sanyer/Istanbul | 90 | 212 202 73 46 | info@skiper.org |
| United Kingdom | Pro-Boat Ltd | CM0 8TE | Burnham-On-Crouch | 44 | (0) 1621 78 54 55 | sales@proboat.co.uk |

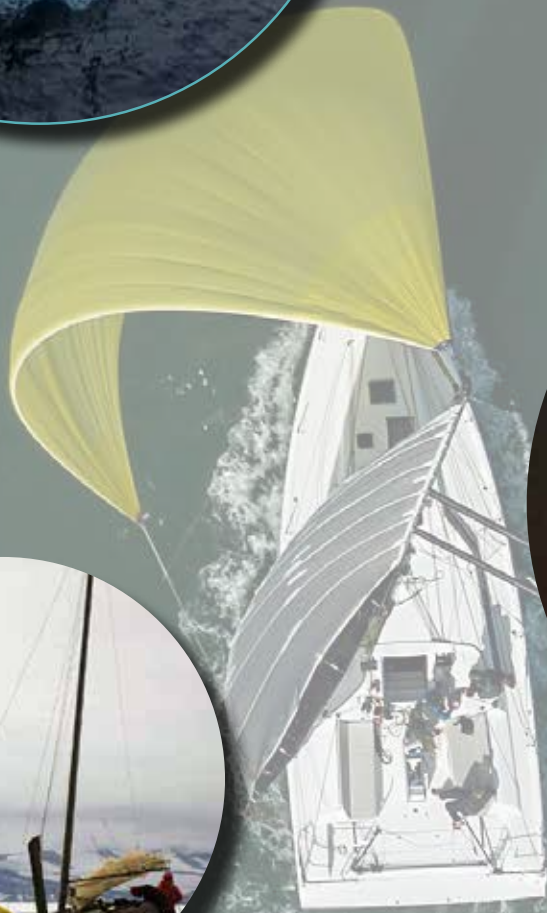

Wichard France
1, ZI de Felet - CS 50085
63307 THIERS cedex FRANCE
Tel: + 33 (0) 4 73 51 65 00
Fax: +33 (0) 4 73 80 62 81
marine@wichard.com

Technical support /
After Sales Service / Hotline
Z.A Pornichet Atlantique
16 av du Gulf Stream
44380 Pornichet - FRANCE
Tel: +33 (0) 2 51 76 00 35
hotline@wichard.com

Wichard North America
3901 Pine Grove Circle Charlotte
NC 28206 - USA
Tel: + 1 (401) 683-5055
Fax: + 1 (802) 655-4689
usasales@wichard.com

Wichard Pacific PTY LTD
PO Box 104 St Peters
NSW 2044 AUSTRALIA
Tel: + 61 2 9516 0677
Fax: + 61 2 9516 0688
info@wichard.com.au