



MARINE
EMERGENCY VEHICLE
INDUSTRIAL
RV



Battery Management
Circuit Protection & Switches
Connectors & Insulators
Custom Panels
Meters
Power Conversion & Connection
Power Distribution

For decades Ancor, BEP, Blue Sea Systems, CZone, Lenco, Marincó, Mastervolt and ProMariner have worked independently to provide innovative electrical products. Now the eight companies are working together to offer comprehensive electrical solutions for marine and mobile applications.

Providing more than products. Providing Solutions.

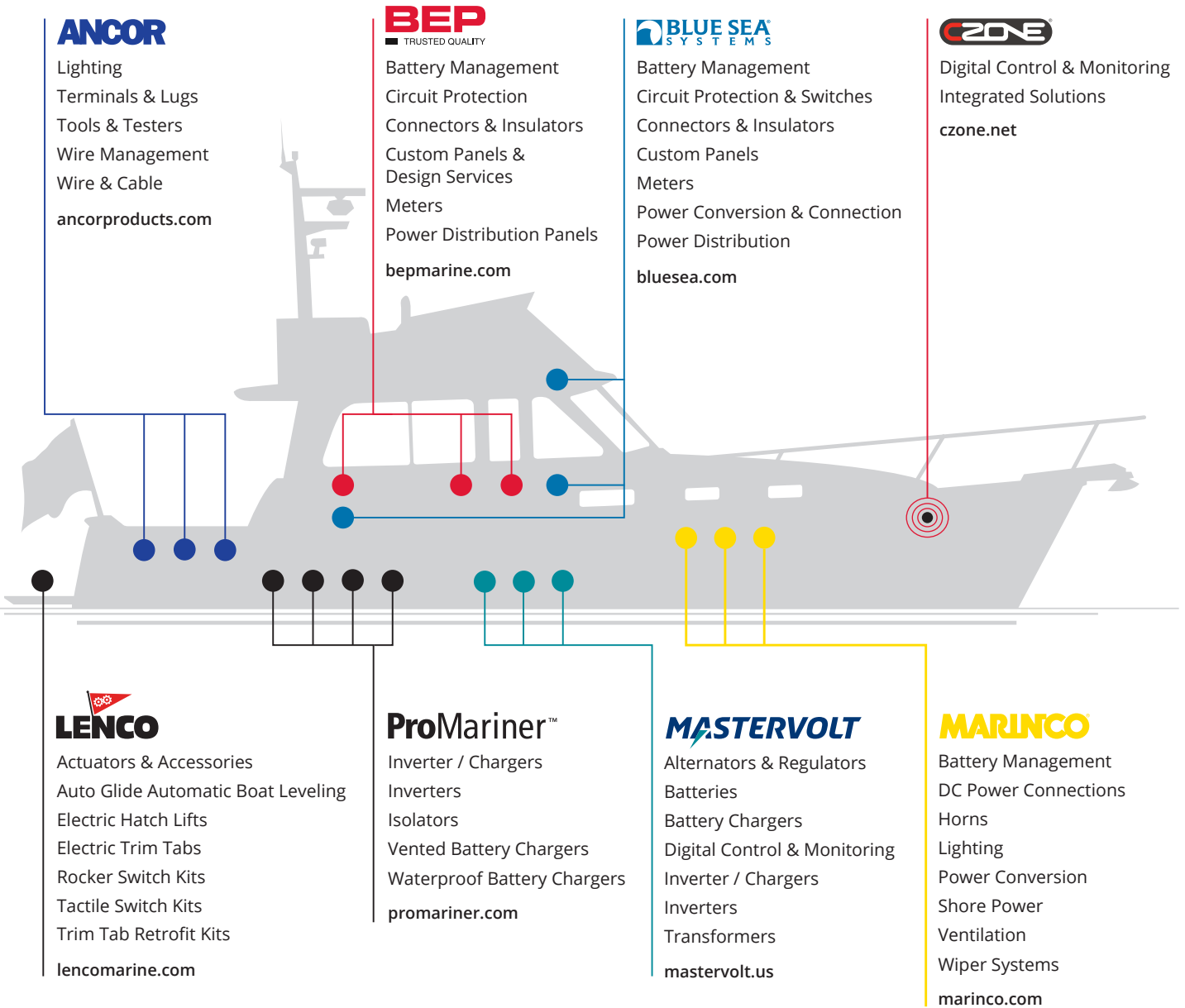

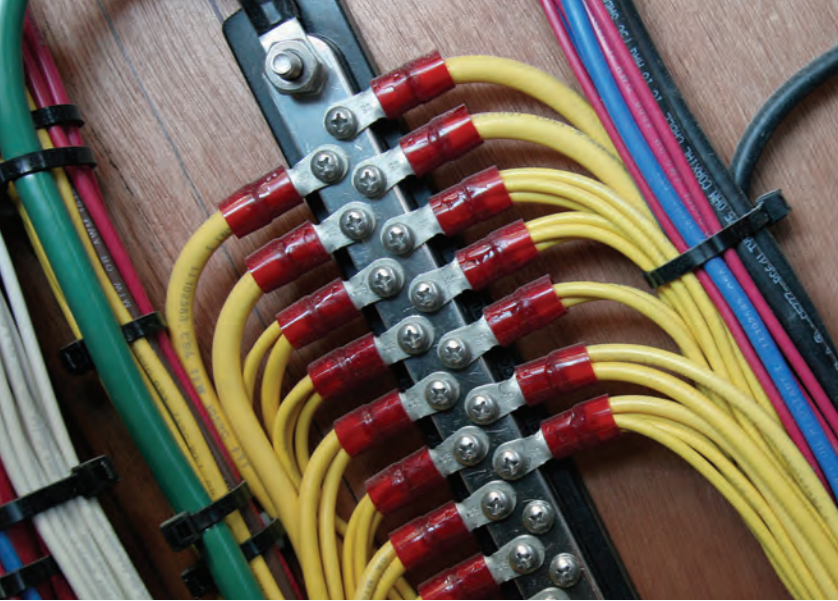

What makes Blue Sea Systems different:

Founder's Vision

Blue Sea Systems was founded in 1992 based on a commitment to create innovative, high quality electrical products to improve the safety, simplicity, and reliability of boating. Since that time the range of product has expanded to over 1,000 items and distributed to customers in over 50 countries including Marine, Industrial, RV, and Specialty Vehicle markets. Products include battery chargers, battery switches, automatic charging relays, fuse blocks, busbars, meters, and both standard and custom power distribution panels. The company is committed to offering quality products that are engineered for the harsh marine environment, built to last, with a guarantee of satisfaction and industry leading technical support.

Selection

Over 1,000 electrical products are designed to work together as a fully integrated system

Fast Delivery

Just in time manufacturing for many products in Bellingham, Washington ensures rapid order fulfillment

Worldwide Access to Product

A distribution network in over 50 countries provides access to products when they are needed

Information

24-hour access to product information, selection tools, and technical articles online at blueseasystems.com

Industry Standards

Industry involvement ensures products meet ABYC, NMMA, and Coast Guard standards

Quality

Blue Sea Systems is committed to product quality and is managed in a manner consistent with international business practices with a robust product warranty program.



2020 **NEW** Products

23



Sure Eject Mounting Adapter

For the Emergency Vehicle market. Easily install 15A and 20A Sure Eject units from the outside of a vehicle.

Part # 7860

23



15A to 20A Adapter Pigtail

For the Emergency Vehicle market. Allows connection between a standard 15A extension cord and a 20A Sure Eject.

Part # 7834

64



ST-Blade Water-Resistant Fuse Block

Provides water-resistant circuit protection for ATO/ATC fuses and circuit breakers.

Part # 5056

79



ATO®/ATC®- Style Low Profile Circuit Breakers

Use a manually resettable circuit breaker instead of an ATO or ATC fuse.

Part #'s 7062-7068

102



Water-Resistant 100A Common BusBar

Provides secure water-resistant bussing for harsh environments.

Part # 2356

110



Stud Mount Insulating Boots

Quickly and easily insulate conductive posts and studs.

Part # 4000

136



360 Panel BusBar Modules

Consolidate bussed terminations in a Custom 360 Panel module. **CUSTOM ONLY**

147



Mini OLED Tank Meters

Confidently monitor tank levels with a simple to read digital OLED display. Compatible with most resistive tank sending units.

Part # 1739 Yellow

Part # 1739200 Blue

147



Mini Blue OLED Meters

Monitors essential electrical system parameters on a bright, waterproof, daylight readable OLED Screen. Now available with blue OLED color that matches other devices on the dash.

Part # 1732200 Ammeter

Part # 1733200 Voltmeter

Part # 1741200 Temperature Meter

156

Push Button Round Format Individual Labels

Individual pictograms and text labels for the 15A Backlit Push Button Switches.



40



Battery Management Panel

Simplify adding a battery to your system with the Mini Add-A-Battery Kit in a 360 Panel.

Part # 1494

64



ST-Blade Water-Resistant Fuse Block

Provides water-resistant circuit protection for ATO/ATC fuses and circuit breakers. Now with wing screws for toolless access.

Part # 5056100

115



Contura Switch Water-Resistant Bilge Panels

Consolidated control, circuit protection and pump indication of up to four bilges.

Part # 8664 2 Bilges

Part # 8665 3 Bilges

Part # 8666 4 Bilges

125



AC Main Circuit Breaker Panel

Panel with integrated AC multimeter and AC main circuit protection.

Part # 1505 Main + 6 pos. w/M2 AC Multimeter

41



L-Series Solenoid Switch

Universal 150A continuous-duty solenoid with an integrated coil economizer.

Part # 7765

90



Surface Mount System Panel Enclosures

Harsh environment enclosures now with expanded AC and DC options for circuit protection.

Part # 3121 ELCI Main + 3 blanks

Part # 3123 ELCI Main + 2 blanks

Part # 3122 ELCI Main + 2 branch pos.

Part # 3128 ELCI Main + 3 branch pos.

Part # 3130 UL 489 AC Main + 4 branch pos.

Part # 3133 DC Main + 5 branch pos.

Part # 3134 DC 6 branch pos.

Part # 3135 UL 489 AC Main + 5 branch pos.

116



Contura Switch Water-Resistant Panels

The industry's best selling panels now with integrated USB charging.

Part # 8121 Gray

Part # 8421 White

Part # 8521 Black

128



AC RCBO (ELCI) Panels

ELCI circuit protection with branch breakers and metering in common panel sizes.

Part # 1503 ELCI + 5 pos.

Part # 1504 ELCI + 5 pos. w/M2 AC Multimeter

42



ML-Series Solenoid Switches

For applications where sustained control signals are required to emulate a Normally Open Solenoid.

Part # 7718

Stripped Wire Cable End

Part # 7718100 Deutsch Connector

Part # 7719 Stripped Wire Cable End

Part # 7719100 Deutsch Connector

102



Water-Resistant - 100A BusBar

Provides water-resistant bussing for harsh environments. Now with wing screws for toolless access.

Part # 2356100

120



DC Branch Circuit Breaker Panels

DC sockets and USB charging integrated in popular sized circuit protection panels.

Part # 1495 4 Position + Dual USB + Socket

Part # 1496 12 Position + M2 Multimeter w/SoC

Part # 1497 8 Position + M2 Multimeter w/SoC + Dual USB + Socket

Part # 1498 8 Position + Dual USB + Socket

Part # 8120 5 Position + Dual USB + Socket

132



AC/DC Combination Panel

Complete AC/DC panel with a M2 Vessel Systems Monitor that provides comprehensive monitoring of AC, DC, tanks and bilges.

Part # 8413 AC Main + 8 pos.

DC Main + 14 pos.

+ M2 Vessel Systems Monitor

Table of Contents

INTRODUCTION

System Diagrams 8

POWER CONVERSION & CONNECTION

Air Brake Compressors 20
 P12 Battery Chargers 21
 P12 Charger Remote 22
 EV Remote Display 22
 Sure Eject™ 23
 BatteryLink® Chargers 24
 Dual USB Chargers 26
 12V Socket & Plug System 27
 Water Resistant Accessory Panels 28
 DeckHand Dimmers 29



BATTERY MANAGEMENT

Manual Battery Switches 32, 38
 Battery Management Panels 40
 Solenoid Switches 41, 54
 Low Voltage Disconnect 42, 55
 Automatic Timer Disconnect 43, 55
 Remote Battery Switches 45, 54
 Automatic Charging Relays 48, 55
 Add-A-Battery Kits 50



CIRCUIT PROTECTION & SWITCHES

Fuses 58, 74
 Fuse Holders 62, 74
 Fuse Blocks 63, 75
 Circuit Breaker Blocks 76
 Circuit Breakers 77, 92
 Surface Mount Systems 90
 Switches 94



CONNECTORS & INSULATORS

BusBars 102
 Terminal Blocks 105
 PowerBars 106
 PowerPost Connectors 108
 Feed Through Connectors 108
 CableCaps 110
 CableClams 111

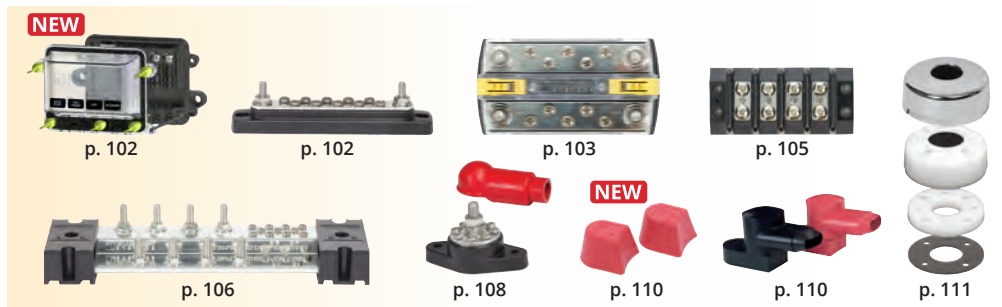

POWER DISTRIBUTION

Waterproof & Water-Resistant	114, 115
Contura Switch Water Resistant	114, 115
WeatherDeck® Waterproof	114, 117
360 Panel System	118
Traditional Metal	119
DC Branch Circuit Breaker	120
AC Main Circuit Breaker	124
AC Branch Circuit Breaker	126
AC RCBO Circuit Breaker	128
AC Source Selection	129
AC/DC Combination	132
Custom 360	134

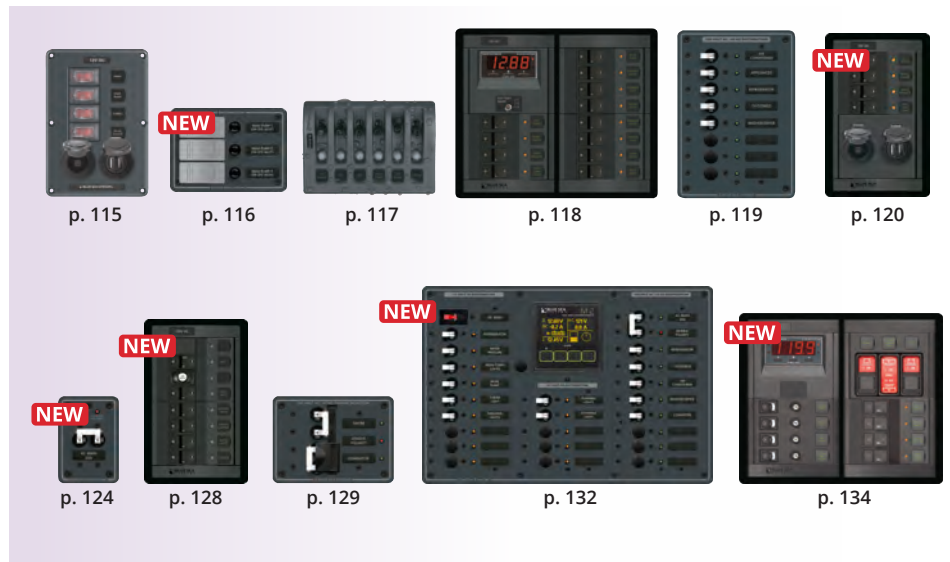

METERS

Analog Meters	142, 150
M2 OLED Monitors	144, 150
Vessel Systems Monitors	146, 150
Mini OLED Meters	147, 150
Mini Clamp Multimeter	147, 150
Digital Meters	148, 150
DC Shunts	151
Universal Temperature Sensor	151
AC Transformers	151



ACCESSORIES

Floyd Bell Turbo Series Alarm	154
Insulating Back Covers	154, 155
120V AC Dual Outlet	154
LED Indicators	155
Lockout Slides	155
Toggle Guard	155
Labels	156, 160



APPENDIX & INDEX

Wire Selection Chart	161
Fuse Selection Chart	162
Fuse Holder Selection Chart	163
Wiring Schematics	164
DC Discussion	166
AC Discussion	167
Marketing Materials	168
Part Number Index	169

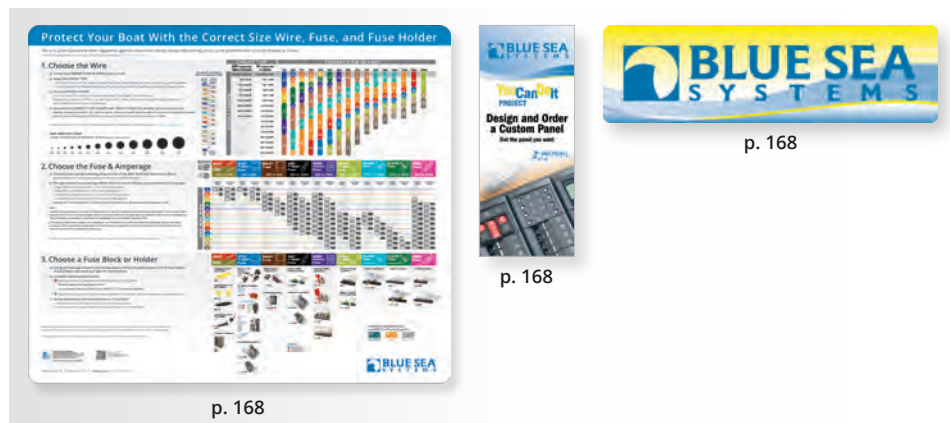

Trailerable Boat System

2 Battery Bank, 1 Engine



AC SOURCE

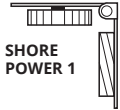

DC SOURCES

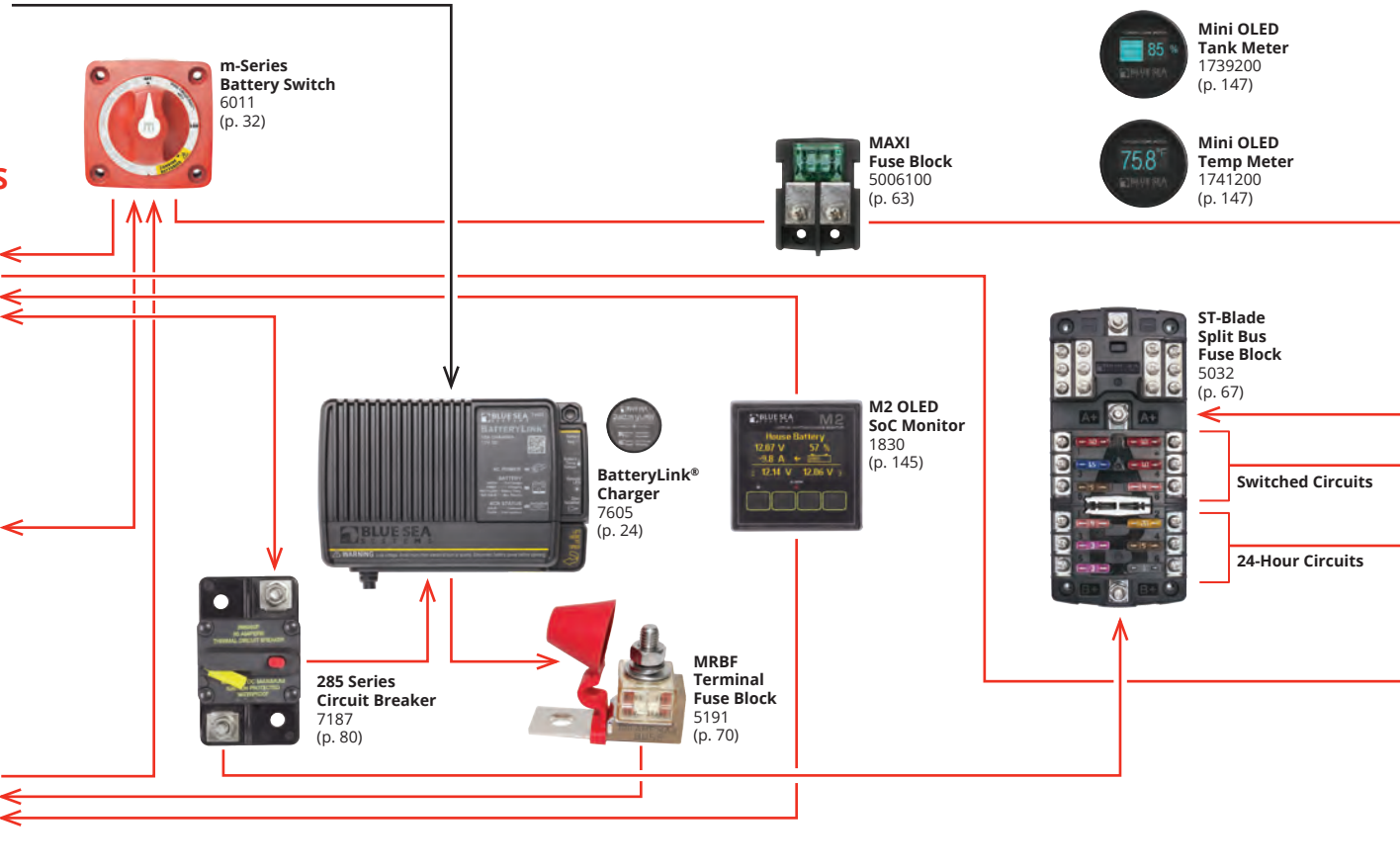
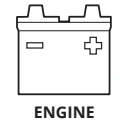
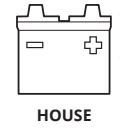

The diagram below is intended for reference only. Consult an electrical professional for system design and circuit protection.

LEGEND | AC Current → DC Current →

DC LOADS

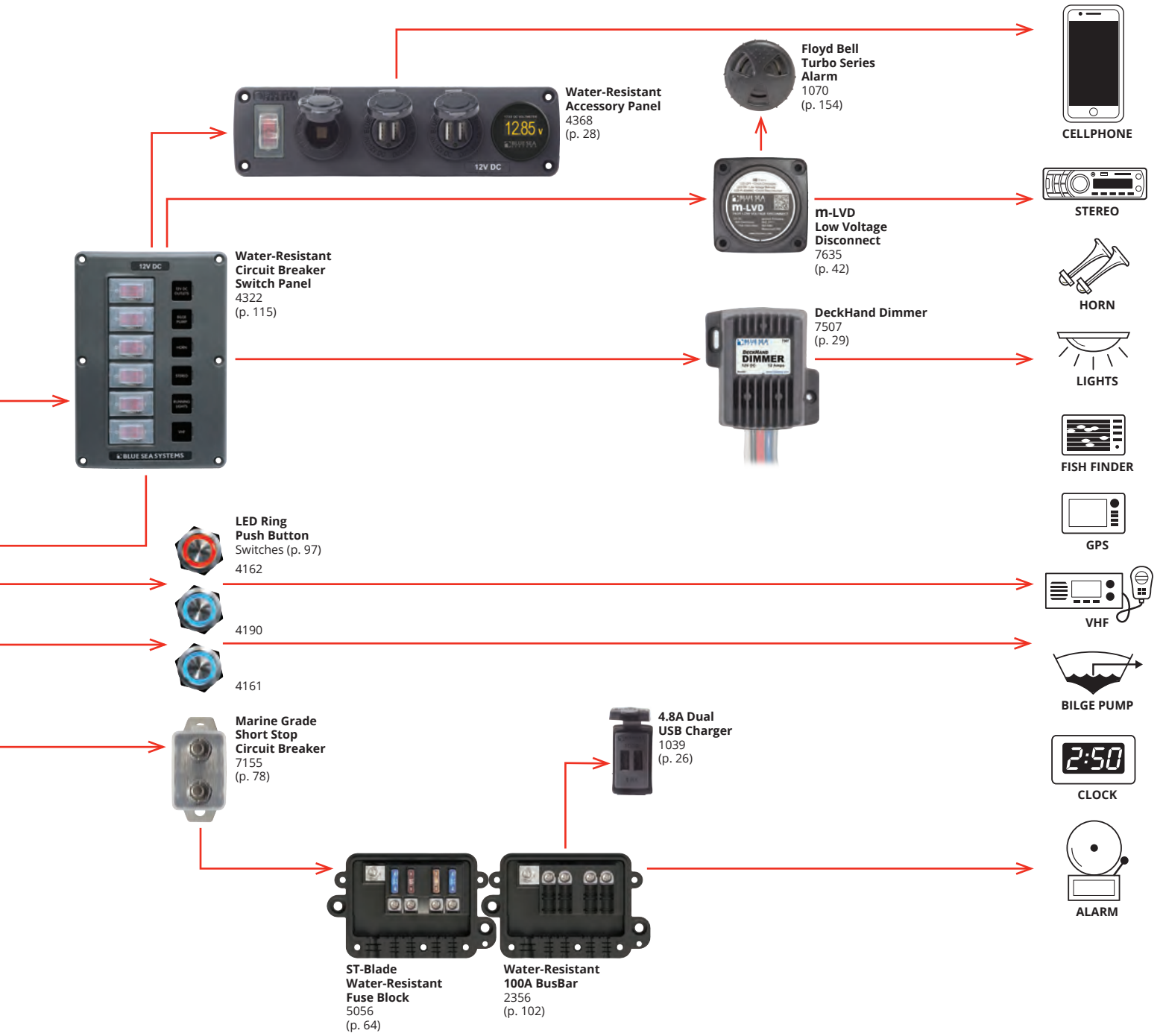

Yacht System

3 Battery Bank, 1 Engine

AC SOURCE

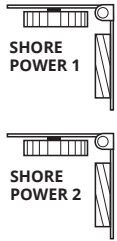

SMS Surface Mount System 3117 (p. 90)



AC/DC 360 Custom Panel (p. 134)

DC SOURCES

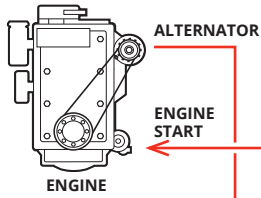

ALTERNATOR

ENGINE START

ENGINE

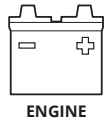

ENGINE



HOUSE



AUXILIARY



SI-ACR Automatic Charging Relay 7610 (p. 49)



P12 LED Remote 7520 (p. 22)

P12 Battery Charger 7532 (p. 21)

ML-Series Remote Battery Switch 7700 (p. 45)

ML-Series Automatic Charging Relay 7620 (p. 53)

ML-Series Remote Battery Switch 7700 (p. 45)



Stud Mount Insulating Boots 4000 (p. 110)



MRBF FuseBlock 5194 (p. 70)



MRBF FuseBlock 5196 (p. 70)



PowerBar 1000 1990 (p. 106)

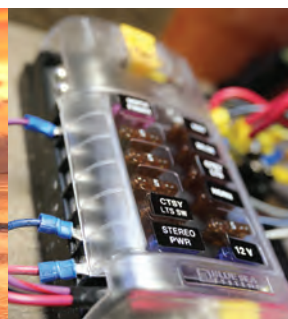

The diagram below is intended for reference only. Consult an electrical professional for system design and circuit protection.

LEGEND | AC Current → DC Current →

AC LOADS

- OUTLETS
- MICROWAVE
- REFRIGERATOR

DC LOADS

- HORN
- RUNNING LIGHTS
- CABIN LIGHTS
- GPS
- VHF
- STEREO
- WINDLASS
- BOW THRUSTER

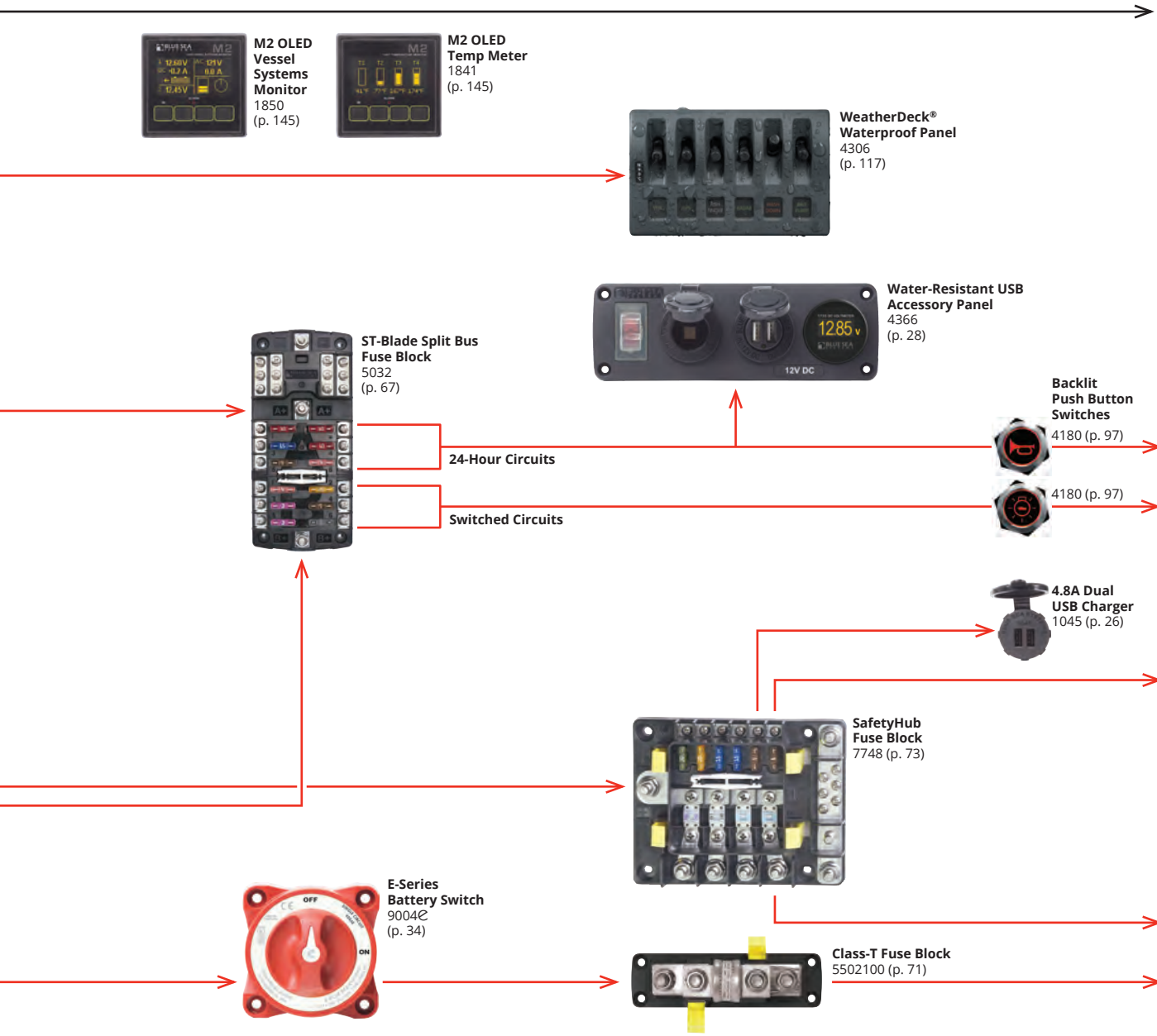

Van System

2 Battery Bank, 1 Engine

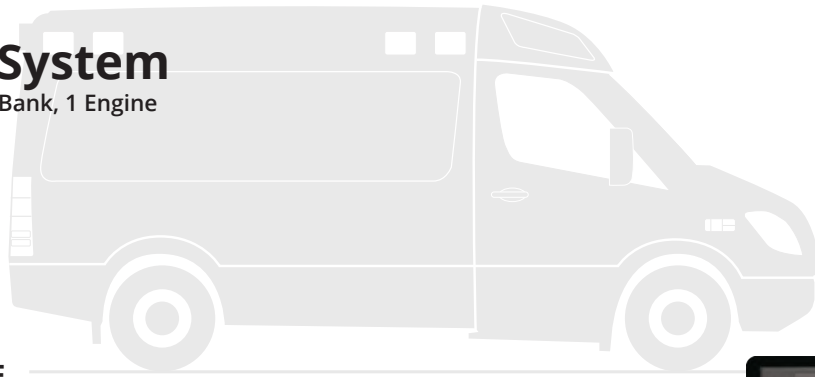

AC SOURCE



SURE EJECT™
ADAPTER
PIGTAIL 7834



Sure Eject™
7851
(p. 23)

DC SOURCES



ENGINE



187-Series
Circuit Breaker
7144
(p. 81)



ML-Series
Automatic
Charging
Relay
7622
(p. 53)



187-Series
Circuit Breaker
7144
(p. 81)



ELECTRONICS



PowerBar
1000
1990
(p. 106)



AC/DC
360
Custom
Panel
(p. 134)



P12 EV
Display
7517
(p. 22)

P12 Battery
Charger
7532
(p. 21)



MRBF
Terminal
Fuse Block
5194
(p. 70)



The diagram below is intended for reference only. Consult an electrical professional for system design and circuit protection.

LEGEND | AC Current → DC Current →

AC LOADS



OUTLETS

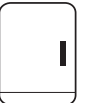

REFRIGERATOR



HEATER

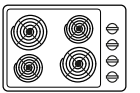

STOVE

DC LOADS



CABIN LIGHTS



CELLPHONE



STEREO



PUMPS



ProMariner Inverter TruePower Plus 07200



ML-Series Remote Battery Switch 7700 (p. 45)



ST-Blade Compact Fuse Block 5046 (p. 69)

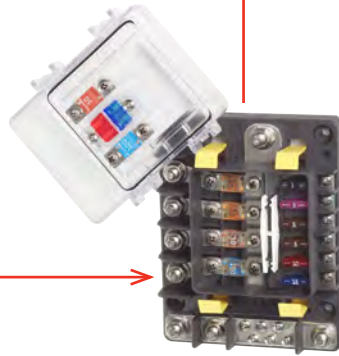

SafetyHub 150 7748 (p. 73)



Class-T Fuse Block 5502 (p. 71)



Mini OLED Ammeter 1732200 (p. 147)



Mini OLED Tank Meter 1739200 (p. 147)



Mini OLED Temp Meter 1741200 (p. 147)



DeckHand Dimmer 7507 (p. 29)

4.8A Dual USB Charger 1045 (p. 26)



Water-Resistant Accessory Panel 4366 (p. 28)



Interceptor/Battalion Chief Vehicle

2 Battery Bank, 1 Engine



AC SOURCE

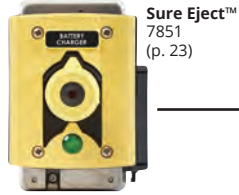

DC SOURCES

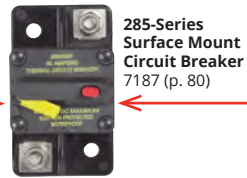
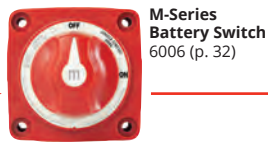
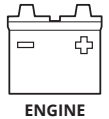
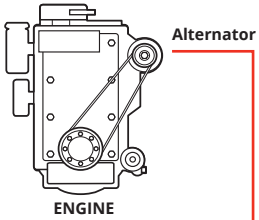

The diagram below is intended for reference only. Consult an electrical professional for system design and circuit protection.

LEGEND | AC Current → DC Current →

DC LOADS

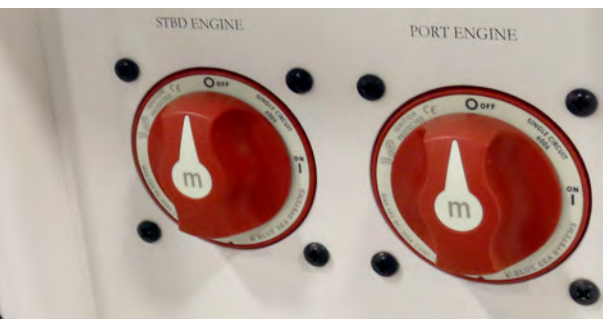
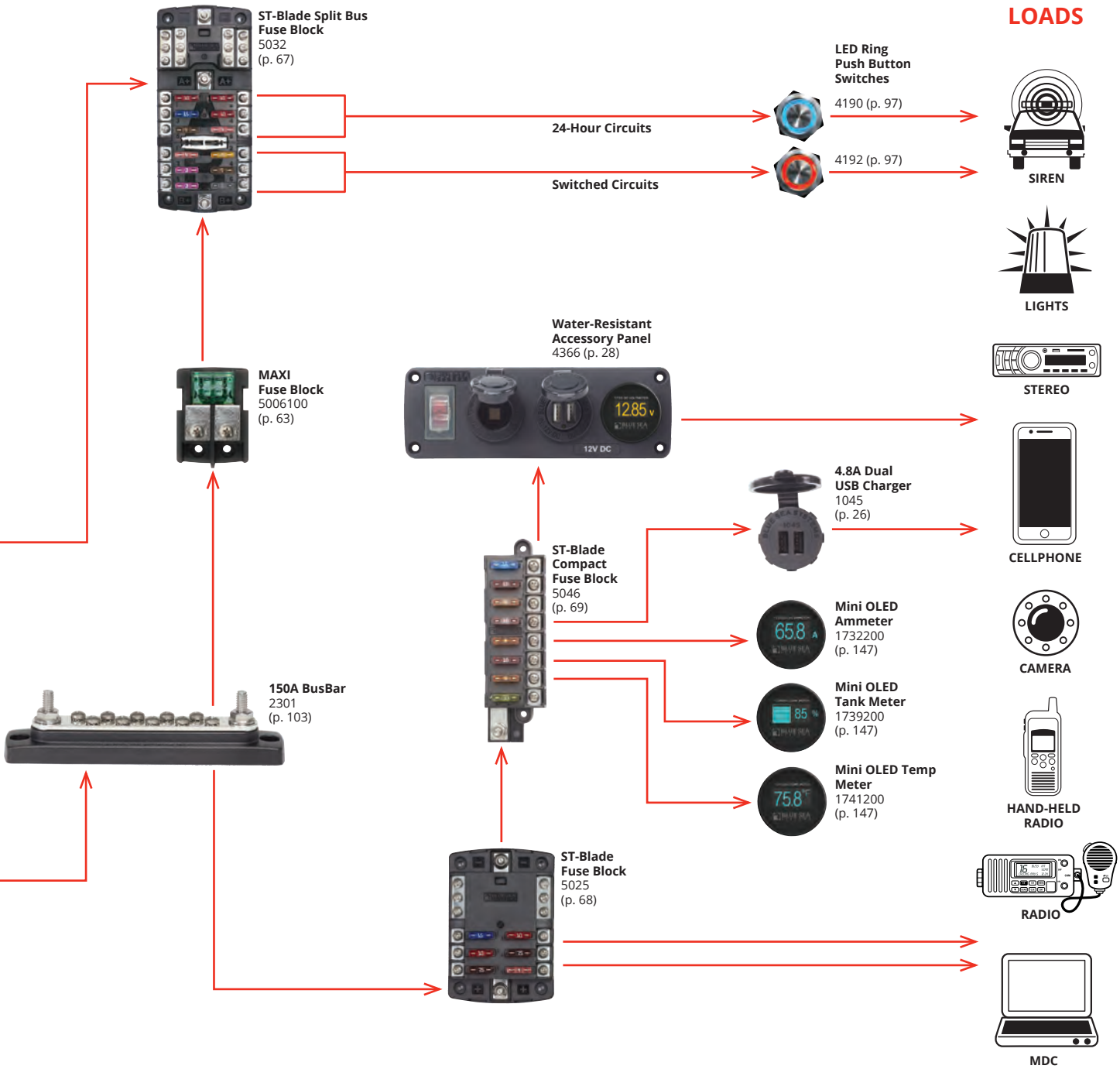

Fire Apparatus System

2 Battery Bank, 1 Engine



AC SOURCE



SURE EJECT™ ADAPTER PIGTAIL 7834



Sure Eject™ 7851 on 7860 Mounting Adapter (p. 23)



P12 Battery Charger 7532 on 7512 Mounting Adapter (p. 21)



P12 EV Display 7517 (p. 22)



M2 OLED Temp Meter 1841 (p. 145)



Short Stop Circuit Breaker 7155 (p. 78)

DC SOURCES

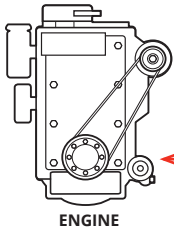

Alternator

ENGINE



Circuit Breaker Mounting Box 3131 (p. 84)

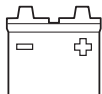

ENGINE



M2 OLED SoC Monitor 1830 (p. 145)



ML-Series Automatic Charging Relay 7622 (p. 53)



PowerBar 1991 (p. 106)



HD-Series Battery Switch 3000 (p. 36)

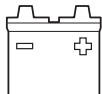

ELECTRONICS



187-Series Circuit Breaker 7144 (p. 81)



The diagram below is intended for reference only. Consult an electrical professional for system design and circuit protection.

LEGEND | AC Current → DC Current →

DC LOADS

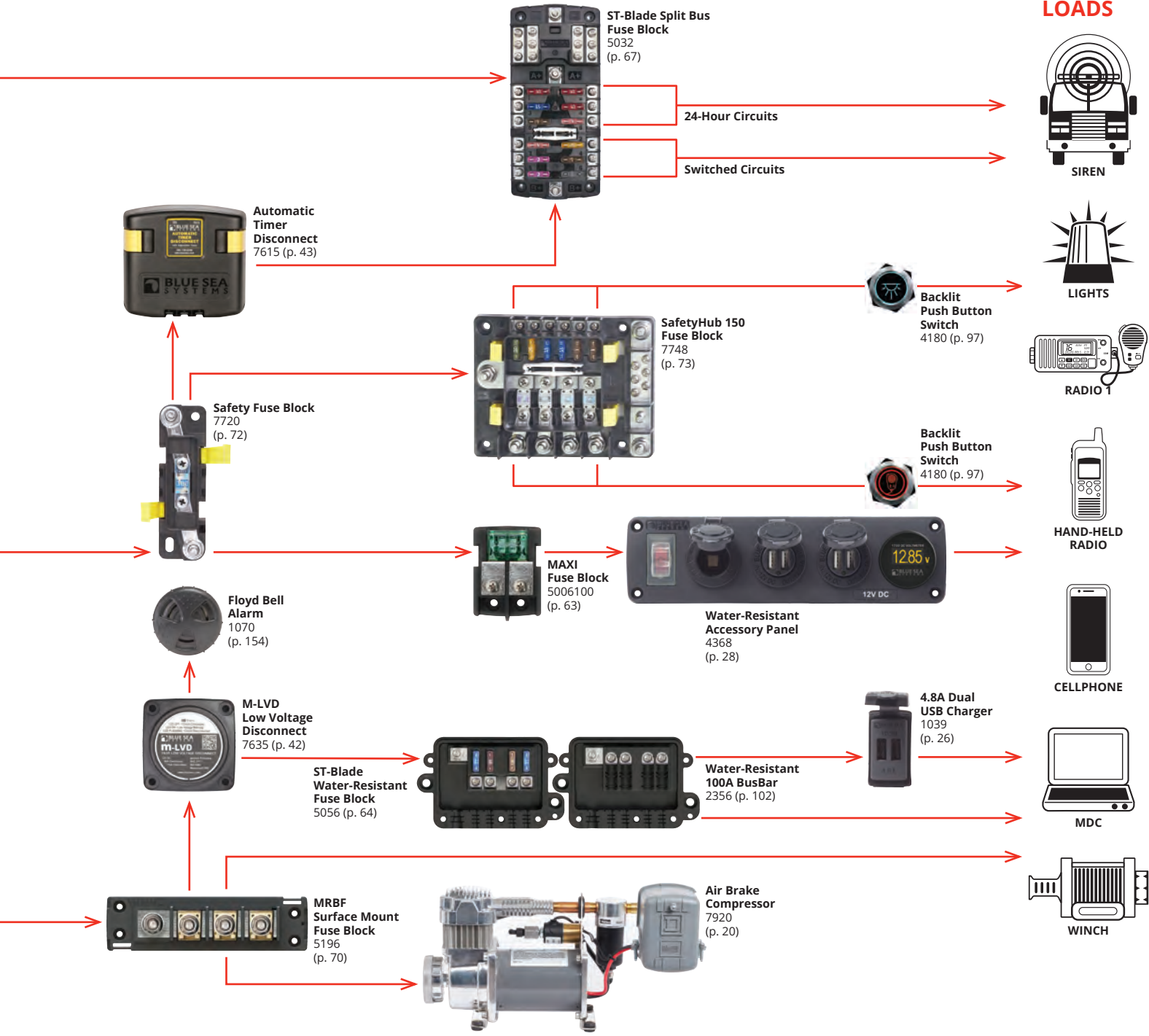

POWER CONVERSION & CONNECTION

Air Brake Compressors

20

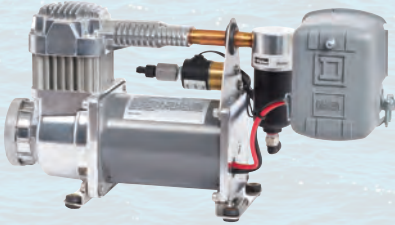

Automatically maintains air brake system at ready status.

P12 Battery Chargers

21



A four stage, three output, dry mount device designed for use in harsh environments.

P12 Battery Charger EV Display and Remote

22



Works with the P12 Battery Chargers

Sure Eject™

23



Automatic AC disconnect ejects power cords upon ignition to prevent damage.



POWER CONVERSION & CONNECTION

BatteryLink® Chargers

24



Charge two batteries at or away from the dock or garage.

Dual USB Chargers

26



Intelligent device recognition allows rapid charging of phones, tablets, or other mobile devices.

12V Socket & Plugs

27



Designed to withstand the rigors of wet environments and constant vibration.

Water-Resistant USB Accessory Panels

28



Panels offer customizable 12 Volt charging and monitoring options.

DeckHand™ Dimmers

29



Digitally controls dimming of non-regulated LED, incandescent, and halogen lights.



Batteries are the heart of the electrical system and are often the single largest electrical expense.

Batteries are sensitive to failure and a shortened life if not charged properly. Modern battery chemistries require adherence to manufacturers' charging recommendations. Battery manufacturers agree precise control of voltage, time, and temperature is critical. Batteries may perform poorly and fail prematurely due to a charger's failure to properly manage these functions. A well designed battery charger will allow these variables to be correctly set for the requirements of each battery type and will manage them properly in the charging process.

Air Brake Compressors

Automatically maintains air brake system at ready status, because lives depend on it.

- Designed for emergency vehicle use
- Automatically turns ON at 95 PSI and OFF at 125 PSI
- Industrial grade compressor provides reliable, long term operation
- Easy installation, no mounting plate required
- Integrated vibration damping mounts
- Serviceable air filter and water separator filter
- Works in conjunction with engine driven compressor
- Integrated auto drain to protect your air system

Nominal Voltage	12V DC
Motor Type	Permanent Magnet
Factory ON-OFF PSI Threshold	ON: 95 PSI, OFF: 125 PSI
Maximum Amp Draw	11A
Operating Temperature Range	4.4°C to 65°C (40°F to 150°F)
Air Outlet	Female 1/4" NPT

Part #	Description
7920	Horizontal Mount Air Brake Compressor
7921	Vertical Mount Air Brake Compressor
7910	Air Filter Assembly - complete
7911	Replacement Air Filter Elements
7912	Replacement Water Separator Filter

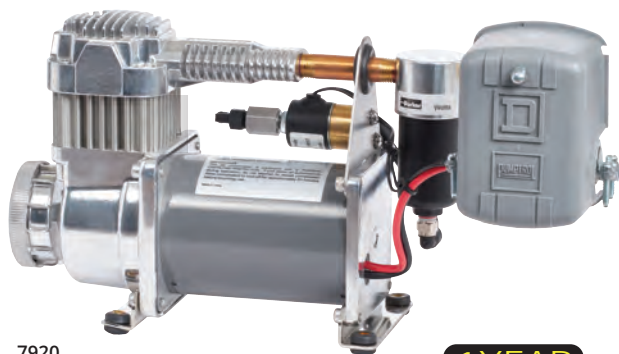

7920

1 YEAR WARRANTY

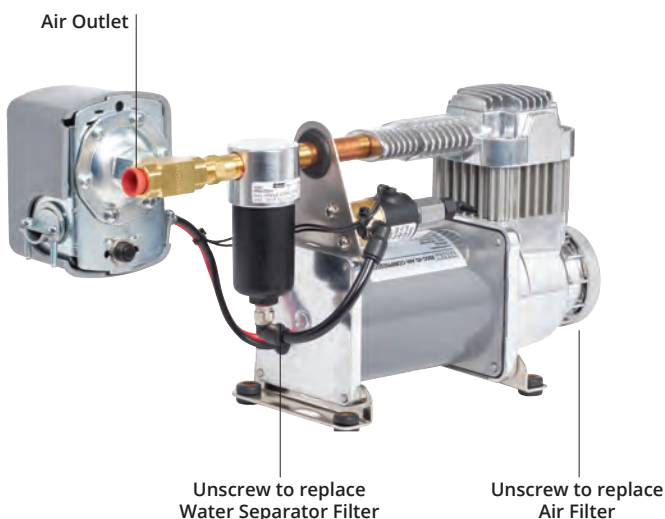

TECH tip™

P12 Four Stage Battery Charging

1. Bulk charges batteries to 75-80% of full charge.
2. Absorption slowly completes remaining charge.
3. PreFloat™ moves each battery individually from Absorption to PreFloat, based on the need of each battery. This prevents overcharging and damage to the batteries. Up to 0.5V difference between Absorption and PreFloat voltages can be achieved.
4. Float maintains battery charge.

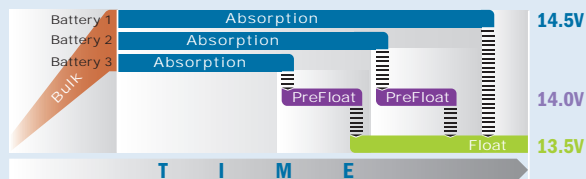

Example of Flooded Lead Acid Battery

Battery Equalization Mode: User selected battery equalizing provides advanced battery conditioning, revitalizing wet acid batteries.

OTHER BATTERY CHARGERS

Conventional battery chargers move all batteries from Absorption to the Float stage simultaneously with no ability to adjust for individual battery requirements.

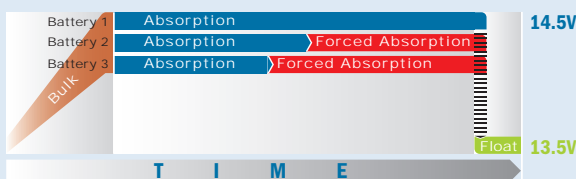

Example of Flooded Lead Acid Battery

Forced Absorption: A period when batteries are potentially over charged.

Charge Coordination

A boat's batteries typically spend less than 2% of their time being charged by the alternator. For the remaining 98% of the time they are being maintained by the AC battery charger. During this time, it is important that the proper charging stage of Bulk, Absorption, PreFloat, or Float be applied to each battery.

UNDERWAY

When engine is running and alternator is charging batteries, ACRs combine batteries, providing charge to each battery from the engine.

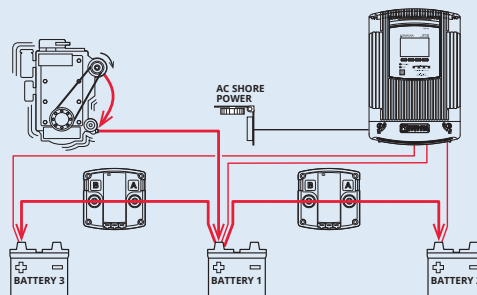

AT THE DOCK

When P12 Battery Charger is operating, communication with ACRs isolates batteries so the proper charge is applied to each battery.

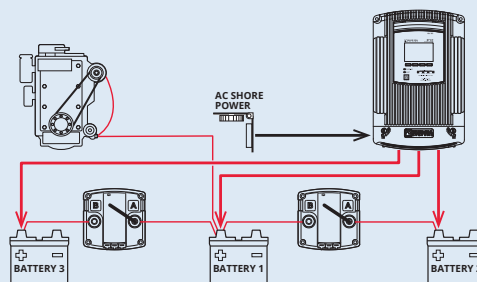

P12 Battery Chargers

Four stage, three output, dry mount design.
Rugged, finned aluminum case

- PreFloat™ stage prevents over charging of start battery
- Power factor corrected for efficient use of AC
- Intuitive diagnostic screens
- User defined charge profiles and customizable settings
- Provides charging for up to three battery banks
- Large, bright display
- Multi-language: English, French, German, Italian, Spanish
- Charge Coordination with Blue Sea Systems Automatic Charging Relays (ACR) controls ACR state ensuring proper float stage for each battery
- Battery Temperature Compensation - adjusts charge voltage based on battery temperature
- AC over and under voltage shut down and automatic restart
- Over and under battery temperature protection - charger will not operate if battery temperature rises above or falls below a set value
- DC over voltage and reverse polarity protection
- Surge and short circuit protection



7532
PATENTED

	7531	7532
Total Output Current	25A	40A
Input AC Current	4.5A @ 115V AC 2.25A @ 230V AC	7.5A @ 115V AC 3.75A @ 230V AC
Recommended Battery Bank Sizes*	60Ah Minimum Example: 1 × Group 24 330Ah Maximum Example: 3 × Group 31	60Ah Minimum Example: 1 × Group 24 440Ah Maximum Example: 4 × Group 31
Nominal Output Voltage	12V DC	
Output Connections	3 positive, 1 negative	
Universal AC Input Voltage	90V-265V AC	
Input Frequency Range	45-65 Hz	
Typical Float Voltage	13.5V DC	
Max. Available Voltage	16.0V DC	
Output Voltage Accuracy	0.05V DC	
Operating Temperature	-20°C (-4°F) to 70°C (158°F)	
Storage Temperature	-30°C (-22°F) to 80°C (176°F)	
Battery Types**	Flooded, Gel, AGM, TPPL, User	
Regulatory	CE marked, Designed and constructed for compliance to UL-1236 Marine, CSA 22.2 No. 107.2, and ABYC A-31 standards. Ignition protection per ISO 8846, and SAE J1171. Meets FCC Part 15, Class B requirements. Designed and tested to comply with California Energy Commission (CEC) efficiency requirements, and ship with these settings by default.	

* Battery bank sizes are tested to California Energy Commission compliance (CEC). Larger and smaller size banks could charge well, but consume slightly more power over the charging cycle.

** Consult battery manufacturer specifications for other battery types to avoid damage. Do not mix battery types.



Part #	Amps	Volts	Width in (mm)	Height in (mm)	Depth in (mm)
7531	25A	12V DC	8.46 (215)	13.00 (330.6)	4.30 (109)
7532	40A	12V DC	8.46 (215)	13.00 (330.6)	4.30 (109)

Related Products



P12 Displays page 22

SI-ACR page 49

ML-Series ACRs page 53

MRBF Fuse Blocks page 70

Battery Charger Mounting Adapter

Easily mount any Blue Sea Systems P12 Battery Charger or ProMariner ProNauticP Battery Charger without drilling new holes

- Mounts directly into industry standard mounting holes from existing chargers
- Integrated nuts allow battery charger mounting fasteners to be inserted from either the front or rear
- Fasteners included with the P-12 Adapter plate:
Qty 4: #10-32 x 0.75" pan head machine screws
Qty 4: #10-32 Nylock Nuts



Part #	Description
7512	Battery Charger Mounting Adapter

EV Battery Charger Display

Intuitive battery monitoring for emergency vehicle use



P12 Charger Summary Screen

5 YEAR WARRANTY

- Designed for emergency vehicle use
- Drop in replacement for traditional rectangular displays
- Automatically detects 1-3 battery banks
- AC charge indication verifies that power is connected and the battery charger is charging
- Plain language fault indication relays if there is a fault with the battery charger
- Dip switch selectable screen configuration allows the display to show voltage bar graphs or the P12 Battery Charger summary screen
- Displays voltage bar graphs even when AC power is not present
- Optional standby mode shuts off screen after 4 hours of inactivity
- Automatic ON based on motion with integrated knock sensor
- Bright, daylight readable, OLED display

Display Size	55mm x 28mm
Display Type	Yellow OLED
Input Voltage	6V-36V DC, reverse polarity protected
Amperage Draw	50 mA - Maximum < 1 mA in Standby Mode - Minimum
Standby Mode	Shuts off screen after 4 hours of inactivity. Will resume normal function upon movement of the vehicle or by tapping the unit several times in succession.
Accuracy	± 1% at 36 Volts DC
Number of Inputs	3 battery inputs with common reference
Regulatory	Monitor face is IP66 - protected against powerful water jets when installed according to instructions.

Part #	Description	Width in (mm)	Height in (mm)	Depth in (mm)
7517	EV Battery Charger Display	4.7 (119.25)	3.2 (80.5)	1.2 (29.7)

P12 Battery Charger LED Remote

Indicates battery charger stage and alerts as well as controlling basic battery charger functions



7520



1521

LED Indicators

- Quick check for green light confirms charging
- Displays charging stage including PreFloat for each battery
- Indicates when the charger is in equalization mode
- Indicates charger's internal fan mode
- Displays the percentage of output current for each battery. Will also indicate maximum output setting when maximum output is adjusted to accommodate for AC source limitations.
- Provides warning and alert status for quick diagnostics

Four Control Buttons

- **Fan:** User adjustable settings (OFF, LOW, or HIGH)
- **Dim/ Alarm:** Provides adjustment to brightness of LEDs on display as well as Silence function for alarms.
- **Output:** User adjustable charger output when AC source limitations exist that require lowering the AC current draw.
- **Standby:** Places P12 Battery Charger into standby mode

Part #	Description	Volts	Width in (mm)	Height in (mm)	Depth in (mm)
7520	LED Remote	12V DC	4.15 (105.46)	3.01 (76.56)	.95 (23.91)
1521	360 Panel	12V DC	4.88 (123.83)	4.75 (120.65)	.95 (23.91)

Related Products



P12 Battery Charger
page 21



Sure Eject™

Automatic AC disconnect ejects power cords upon ignition to prevent damage

- Designed for emergency vehicle use
- Motor driven design ensures years of reliable operation
- The ejection piston is self-recessing, with no cocking required
- Keyed plug design allows for easy one-handed insertion of connector
- Anti-arcing design on insertion and ejection
- Built in status LED indicates the presence of AC power and ejection alerts
- Automatically attempts additional ejections if needed
- Compatible with existing 15A and 20A connectors already in the station
- Standard mounting holes for easy retrofit
- Includes connector, yellow cover and 5 label kit
- 6 color covers available
- Pigtails offer a secondary method of disconnecting from shore power for added reliability (sold separately)

Operating Voltage Range	8V -16V DC
Nominal Voltage	120V AC
Continuous Rating	7850: 15A, 7851: 20A

Part #	Description
7850	15A Sure Eject
7850001	15A Sure Eject - No Cover
7851	20A Sure Eject
7851001	20A Sure Eject - No Cover
7840	15A Connector
7841	20A Connector
7820	Yellow Cover
7821	Red Cover
7822	Black Cover
7823	White Cover
7824	Blue Cover
7825	Grey Cover
7830	15A Sure Eject Yellow Pigtail
7831	20A Sure Eject Yellow Pigtail
7832	15A Standard Black Pigtail
7833	20A Standard Black Pigtail
7834	15A to 20A Adapter Pigtail



5 YEAR WARRANTY

7850 / 7851



7840 / 7841



7830 / 7831



7832 / 7833



7834

Related Products



P12 Battery Charger
page 21



EV Battery Charger
Display
page 22

Sure Eject Mounting Adapter **NEW**

Easily install 15A and 20A Sure Eject units from the outside of a vehicle

- Allows one person installation of Sure Eject
- No special shaped cutouts required
- Threaded backing plate secures Sure Eject to vehicle without added hardware
- Compatible with all 15A and 20A Sure Eject ejection units and covers



Part #	Description
7860	Sure Eject Mounting Adapter

BatteryLink® Chargers

Charge two battery banks with shore power or the engine's alternator

- AC charging at the dock or garage: Use AC shore power to charge two isolated battery banks with the 3 stage battery charger
- DC charging away from the dock or garage: Share the DC power from the alternator with both the start and the auxiliary battery through the integrated ACR
- Emergency jump start by combining both batteries if start battery is low. (20A model only) - single pole/single throw switch required. (sold separately)
- Battery temperature compensation prolongs battery life (temperature sensor 1820 included)
- Start isolation protects sensitive electronics from voltage sags and spikes
- Includes LED remote indicator for charge status at the helm
- Snap-on insulating cover



Nominal Output Voltage	12V DC
Output Connections	2 positive, 1 negative
Universal AC Input	100V-240V AC, 50/60 Hz
Typical Float Voltage (25°C)	13.5V DC
Typical Absorption Voltage (25°C)	14.4V DC
ACR Combine Voltage	13.0V
ACR Open Voltage	12.75V
Terminal Stud Size	1/4"-20 (accepts M6 ring terminal)
Maximum 1/4" Terminal Stud Torque	60 in-lb (6.8 Nm)
Positive Terminal Stud Size (20A model only)	3/8"-16 (accepts M10 ring terminal)
Maximum 3/8" Terminal Stud Torque	140 in-lb (15.8 Nm)
Quick Connect Terminal Size	1/4" x 0.032"
Battery Types	Flooded, AGM, TPPL

North American Models

Part #	Total Output Current	ACR Continuous	Plug Style
7605	10A	65A	North American: NEMA 5-15P
7608	20A	170A	North American: NEMA 5-15P

Regulatory

Designed and constructed for compliance to UL-1236 Marine, CSA 22.2 No. 107.2 and ABYC A-31 standards. Ignition protected per ISO 8846 and SAE J1171. Meets FCC Part 15, Class B requirements. Designed and tested to comply with California Energy Commission (CEC) efficiency standards. Waterproof IP67 - protected against immersion up to 1 meter for 30 minutes (see inside back cover)

International Models

Part #	Total Output Current	ACR Continuous	Plug Style
7604	10A	65A	European: CEE 7/7
7603	10A	65A	International: Bare wire
7607	20A	170A	European: CEE 7/7
7606	20A	170A	International: Bare wire
7609	20A	170A	Australia/New Zealand: AS/NZS 3112

Regulatory

CE Certified, Designed and constructed for compliance to EN60335-2-29. Ignition protected per ISO 8846 and SAE J1171. Waterproof IP67 - protected against immersion up to 1 meter for 30 minutes (see inside back cover)

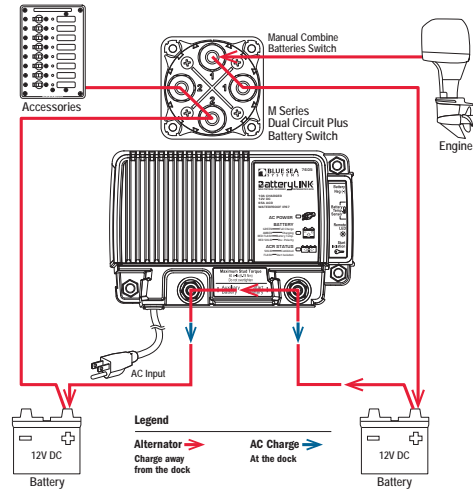

10A BatteryLink Charger

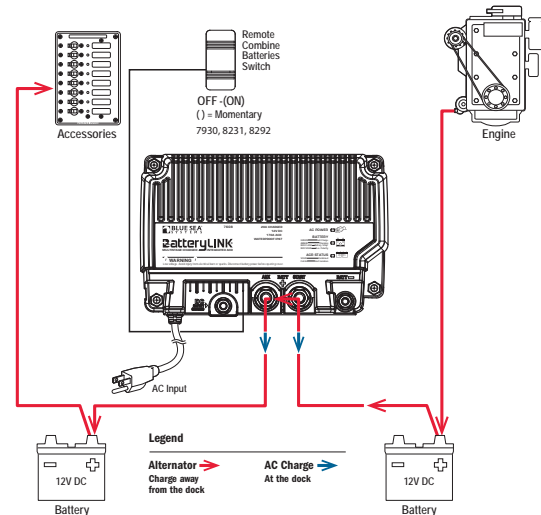

20A BatteryLink Charger



AC & DC Battery Charging Explained

DC Charging (Away from the Dock or Garage)

The BatteryLink Charger incorporates DC charging through an integrated Automatic Charging Relay (ACR). An ACR uses a relay combined with a voltage sensing circuit. When a DC charge is applied to the start battery, and causes the voltage to rise above 13.0V, the relay closes and combines the two batteries to share the charge. When the charge is taken away or a load on the battery causes the voltage to drop below 12.75V, the relay will open, isolating the two batteries. This means that even when the BatteryLink Charger is disconnected from AC power you can charge both your battery banks with a DC charging source, like an engine alternator.

AC Charging (At the Dock or Garage)

The BatteryLink Charger is powered by AC when the cord is plugged in, and will source current to charge your batteries. However, unlike a typical two bank charger, the BatteryLink Charger will charge both batteries simultaneously using the integrated ACR. This works in the same way as when an external DC charging source is used. When AC power is applied, and the voltage of the start battery rises above 13.0V, the ACR will close. This combines the batteries, allowing charge current to flow to the auxiliary battery as well as the start battery. For this reason, the BatteryLink Charger can only be used in 12V applications.



10A Battery Charger - 65A ACR
 7603 International: Bare wire
 7604 European: CEE 7/7
 7605 North American: NEMA 5-15P



20A Battery Charger - 170A ACR
 7606 International: Bare wire
 7607 European: CEE 7/7
 7608 North American: NEMA 5-15P
 7609 Australia/New Zealand: AS/NZS 3112

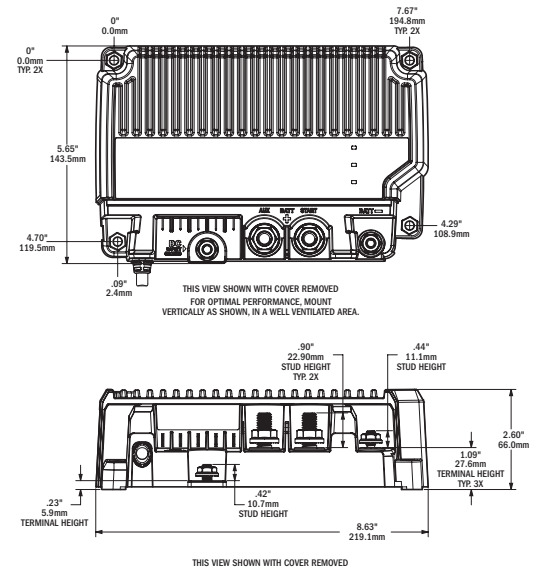
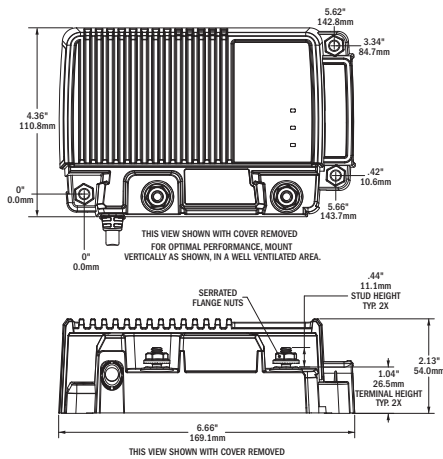

Related Products



Related Product



12/24V Dual USB 2.1A Chargers

Charge two mobile devices on the go



1016

1016200

- Compatible with popular mobile devices
- Internal fusing
- Conformal coated circuit board for the harsh marine environment
- Protective dust cap keeps debris and moisture out
- Mounts in a common 1-1/8" hole

Maximum Output Current	2.1A DC (total)
Input Voltage Range	9V-32V DC
Output Voltage	5V DC ±5%
Port Configuration	D +=2.0V, D-=2.8V
Parasitic Current Draw	15mA
Thermal Overload Protection	Yes
Short Circuit Protection	Yes
Reverse Polarity Protection	Yes
USB	2.0, Type A
Cutout Dimensions	1-1/8" (29 mm) diameter
Regulatory	RoHS, CE certified

Part #	Description	Color
1016	Socket Mount Charger	Black
1016200	Socket Mount Charger	White

Related Products



Water-Resistant USB Accessory Panels page 28



USB Extension

Control a stereo or other device remotely from a phone or tablet in the cockpit.

- USB 2.0 data/voltage port easily mounts at the dash with a prewired connecting cable that conveniently plugs directly into the USB on the stereo.
- Protective dust cap with tether keeps out dust and spray

Cable Length	5 ft (1.524M)
Cutout Dimensions in (mm)	1-1/8" (29 mm) diameter
USB	2.0, Type A

Regulatory

IP66 - protected against powerful water jets (see inside back cover)

PN	Description
1044	12V DC USB

12/24V Dual USB 4.8A Chargers

Intelligent device recognition maximizes charge rate for phones, tablets, or other mobile devices



1039

1045

- Charges at the speed required by specific devices
- Internal filtering for reduced electronic interference
- Over temperature protection
- Conformal coated circuit board for the harsh marine environment
- Protective dust cap keeps debris and moisture out
- 1039 Mounts in an existing contura switch aperture
- 1045 Mounts in a common 1-1/8" hole

Maximum Output Current	4.8A DC (total)
Input Voltage Range	9V-32V DC
Output Voltage	5V DC ±5%
Port Configuration	Intelligent Device Recognition
Parasitic Current Draw	1mA
Thermal Overload Protection	Yes
Short Circuit Protection	Yes
Reverse Polarity Protection	Yes
USB	2.0, Type A
Cutout Dimensions	1039 - 1.45" × 0.83" (36.83 × 21.08 mm) 1045 - 1-1/8" (29 mm) diameter
Regulatory	RoHS, CE certified

Part #	Description
1039	Switch Mount Charger
1045	Socket Mount Charger

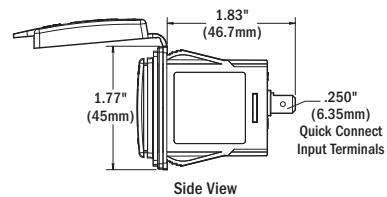

Side View

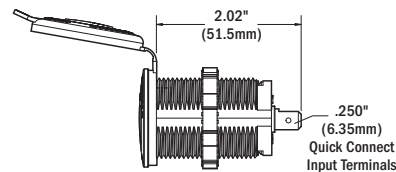

Side View

Related Products



Water-Resistant USB Accessory Panels page 28

48V Dual USB 4A Chargers

Intelligent device recognition maximizes charge rate for phones, tablets, or other mobile devices



1038

1046

- Ideal for golf carts and other 48V systems
- Spring-hinged cover keeps debris and moisture out
- Charges at the speed required by specific devices
- Internal filtering for reduced electronic interference
- Over temperature protection
- Conformal coated circuit board for the harsh marine environment
- 1038 Mounts in an existing contura switch aperture
- 1046 Mounts in a common 1-1/8" hole

Maximum Output Current	4A DC (total)
Input Voltage Range	32V-64V DC
Output Voltage	5V DC ±5%
Port Configuration	Intelligent Device Recognition
Parasitic Current Draw	1mA
Thermal Overload Protection	Yes
Short Circuit Protection	Yes
Reverse Polarity Protection	Yes
USB	2.0, Type A
Cutout Dimensions	1038 - 1.45" × 0.83" (36.83 × 21.08 mm) 1046 - 1-1/8" (29 mm) diameter
Regulatory	RoHS, CE certified

Part #	Description	Part #	Description
1038	Switch Mount Charger	1035	Spring-hinged cover for 1038 & 1039
1046	Socket Mount Charger	1036	Spring-hinged cover for 1046 & 1045

360 Panels

Integrates DC Socket and Dual USB Chargers with 360 Panel System



1472

1478

Part #	Description	Width in (mm)	Height in (mm)	Depth in (mm)
1472	2 × 1011	4.88 (123.83)	4.75 (120.65)	1.50 (38.10)
1478	1 × 1011, 1 × 1016	4.88 (123.83)	4.75 (120.65)	1.50 (38.10)

12 Volt Socket and Plugs

Designed to withstand the rigors of wet environments and constant vibration

- Corrosion resistant materials
- Twist lock system - plug locks securely into socket
- Internal strain relief and cord seal
- Nickel plated copper alloy used for all current carrying components
- Plug has a sealing ring to keep out spray and make it seat firmly in the socket
- Socket features a protective dust cap that keeps debris and moisture out
- 1012 and 1013 heavy duty 18 gauge wire
- 1012 cord reaches up to 6 feet

Voltage Nominal	12V DC
Amperage Max. Operating	15A DC (socket)
Amperage Max. Operating	10A DC (plug)
Socket Cutout Dimensions	1-1/8" (29 mm) diameter

Part #	Description	Dust Cap
1010	Plug	--
1011	Black Socket	Yes
1011200	White Socket	Yes
1012	Single Plug with Single Socket Extension	Yes
1013	Single Plug with Dual Socket Extensions	Yes
1014	Mounting Bracket for Sockets	--
1015	Plug and Socket Set - Includes 1010 and 1011	Yes



1011

1011200

1010

1012

1014

1013

Water-Resistant Accessory Panels

Easy to install accessory panels include a 15A circuit breaker switch and pre-wired harness. Panels offer customizable 12V charging and monitoring options.

- Pre-wired harness included in all panels for easy installation
- Silicon breaker boots and gasket protects against water ingress
- Illuminated Carling Technologies 15A circuit breaker switch allows the ability to shut off panel preventing parasitic draw
- Polycarbonate/ABS panel face is UV-stabilized, flame retardant, and will not corrode
- 12V DC only

Regulatory CE certified (4367, 4364, 4369 Only)
IP66 - protected against powerful water jets (see inside back cover)

Part #	Description	Width in (mm)	Height in (mm)	Depth in (mm)
4363	15A Circuit Breaker, 12V Socket, 2.1A Dual USB Charger	4.94 (125.4mm)	2.25 (57.2mm)	2.53 (64.3mm)
4364	15A Circuit Breaker, 2x Blank Apertures	4.94 (125.4mm)	2.25 (57.2mm)	Based on installed components
4365	15A Circuit Breaker, 12V Socket, 2x 2.1A Dual USB Chargers	6.61 (168.0mm)	2.25 (57.2mm)	2.53 (64.3mm)
4366	15A Circuit Breaker, 12V Socket, 2.1A Dual USB Charger, Mini Voltmeter	6.61 (168.0mm)	2.25 (57.2mm)	2.75 (69.8mm)
4367	15A Circuit Breaker, 3x Blank Apertures	6.61 (168.0mm)	2.25 (57.2mm)	Based on installed components
4368	15A Circuit Breaker, 12V Socket, 2x 2.1A Dual USB Chargers, Mini Voltmeter	8.29 (210.5mm)	2.25 (57.2mm)	2.75 (69.8mm)
4369	15A Circuit Breaker, 4x Blank Apertures	8.29 (210.5mm)	2.25 (57.2mm)	Based on installed components



4367



4364



4365



4363



4366



4368

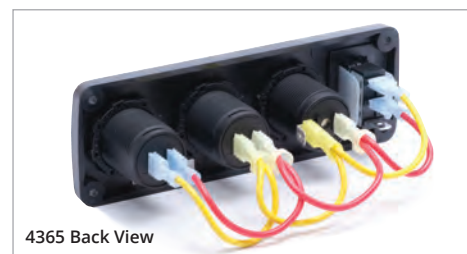

4365 Back View



4369

Related Products



2.1A Dual USB
Chargers
page 26



4.8A Dual USB
Chargers
page 26



12V Socket
page 27



Mini Voltmeter
page 147



Mini Ammeter
page 147



Mini Temp Meter
page 147



Mini Tank Meter
page 147

DeckHand™ Dimmers

Digitally controls dimming of non-regulated LED, incandescent, and halogen lights

- Illuminated exit with adjustable time delay
- Supports multiple switch locations
- Memory for last dimmer setting
- Bulb saver prevents bulb aging while batteries are being charged
- Provides continuous voltage control from 0 to 100% of input voltage
- Offset mounting tabs allow dimmers to be mounted close together
- Retail package includes momentary SPDT (ON)-OFF-(ON) switch 8216 (p. 94)

Maximum Parasitic Current	<2mA
Temperature Rating	-40°C to 85°C
Regulatory	
CE marked	
Meets ISO 8846 and SAE J1171 external ignition protection requirements	

IGNITION PROTECTED

Part #	Amps	Volts	Operating Range	Width in (mm)	Height in (mm)	Depth in (mm)
7506	6A	12V DC	9V-16V	3.23 (82.0)	3.47 (88.1)	1.30 (33.0)
7504	6A	24V DC	18V-32V	3.23 (82.0)	3.47 (88.1)	1.30 (33.0)
7507	12A	12V DC	9V-16V	3.23 (82.0)	3.47 (88.1)	1.30 (33.0)
7509	12A	24V DC	18V-32V	3.23 (82.0)	3.47 (88.1)	1.30 (33.0)
7508	25A	12V DC	9V-16V	3.23 (82.0)	3.47 (88.1)	1.30 (33.0)



7508

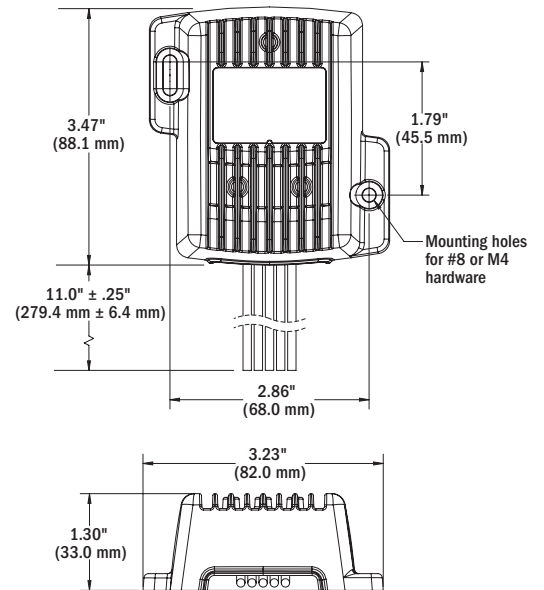

TECH tip™

Illuminated Exit

The illuminated exit feature allows boaters to safely disembark before the lights automatically turn off. Using the illuminated exit feature:

One minute delay: Hold the switch in up position for 2 seconds, lights will flash. Release switch after first flash and the lights will remain on for 1 minute.

Two to five minute delay: Hold the switch in up position for 1-4 seconds after the first flash. Release the switch after 2 to 5 flashes. The lights will remain on for 1 minute for each flash up to a maximum of 5 minutes.

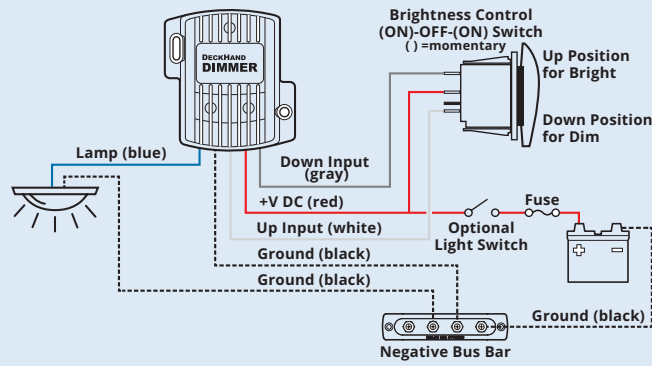

Example of nested DeckHand Dimmers

BATTERY MANAGEMENT

Manual Battery Switches

32



Commonly used on small boats or vehicles where the batteries are located near the operator, allowing the high amperage switching and the control of the switch to be the same location.

Battery Management Panels

40

NEW

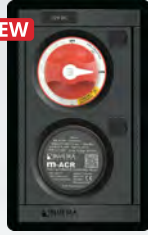

Easily manages multiple battery bank systems.

Solenoid Switches

41

NEW



Electronic switches with no manual control, for circuits where a manual battery disconnect is offered elsewhere in the circuit.

Low Voltage Disconnect (LVD)

42



Senses low battery voltage and disconnects non-critical loads to save power for engine starting.



BATTERY MANAGEMENT

Automatic Timer Disconnect (ATD)

43



Adjustable time or voltage based battery disconnect automatically shuts off devices to preserve battery power.

Remote Battery Switches (RBS)

45



Used when there is not an easily accessible location near the batteries to mount the battery switch, requiring either a long cable run or a battery switch mounted in a difficult to access location.

Automatic Charging Relays (ACR)

46



Automatically combines two battery banks during charging and isolates batteries when discharging and optionally when starting the engine.

Add-A-Battery Kits

50



Simplify switching and automate charging for two battery bank systems. Simply turn the battery switch On when you arrive and Off when you leave.



Battery management is central to the safe operation of a boat or vehicle.

All boats and vehicles with an engine have at least one battery with the primary purpose of starting the engine and providing power for loads such as lights, pumps, and electronics. The safe switching between batteries, loads, and charge sources is achieved using products in this section.

M-Series Battery Switches

300 Amps continuous rating for outboards and small gasoline or diesel engines

- Tin-plated copper studs for maximum conductivity and corrosion resistance
- Studs accept 3/8" (M10) ring terminals
- 7/8" (22 mm) stud length accepts multiple cable terminals
- Blue Sea Systems one-piece terminal stud design never loosens over time
- One-piece stainless flange nuts ensure safe and secure connections
- Isolating cover protects rear contacts
- Breakout tabs allow wire access in any direction
- 6 Circuit label set included (not included with 6004, 6005, 6004200, 6005200)
- Icon Circuit Identification Label Kit available 7902 - sold separately (p. 160)

Part #	6004, 6005, 6006, 6004200, 6005200, 6006200	6007, 6007200, 6008, 6008200	6010, 6011, 6010200, 6011200
Cranking Rating: 30 sec.	900A	900A	675A per circuit
Intermittent Rating: 5 min.	500A	500A	450A per circuit
Continuous Rating	300A	300A	300A per circuit
Voltage Max. Operating	48V DC	32V DC	32V DC

Regulatory
 CE marked, ISO 8846, UL Listed - UL 1107 electric power switches
 Meets American Boat and Yacht Council (ABYC) requirements
 Meets UL 1500 and SAE J1171 external ignition protection requirements
 IP66 - protected against powerful water jets (see inside back cover)

IGNITION PROTECTED

Part #	Description	Color
6004	Single Circuit ON-OFF with Locking Key	Red
6004200	Single Circuit ON-OFF with Locking Key	Black
6005	Single Circuit ON-OFF with Key	Red
6005200	Single Circuit ON-OFF with Key	Black
6006	Single Circuit ON-OFF	Red
6006200	Single Circuit ON-OFF	Black
6007	Selector 4 Position	Red
6007200	Selector 4 Position	Black
6008	Selector 3 Position	Red
6008200	Selector 3 Position	Black
6010	Dual Circuit™	Red
6010200	Dual Circuit™	Black
6011	Dual Circuit Plus™	Red
6011200	Dual Circuit Plus™	Black
7903	Removable key for 6004	Red
7903200	Removable key for 6004200	Black
7900	Removable key for 6005	Red
7900200	Removable key for 6005200	Black
7901	Removable knob	Red
7901200	Removable knob	Black
9159	Paralleling link bus (2 pack)	-
1139	360 Panel Battery Switch Module	-

For the full list of specifications and operation diagrams see pages 38-39
 For the wiring schematics for typical applications see pages 164-165

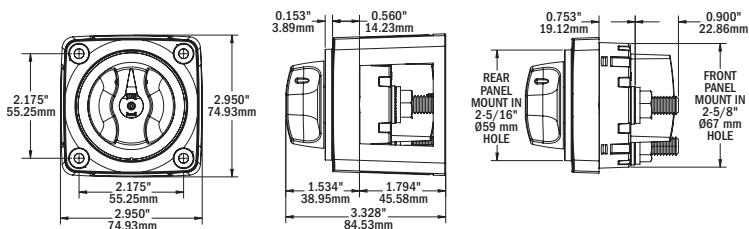

Mounting Options



M-Series Battery Switch Mounting Panel



1139 (switch sold separately)

Dimensions (W x H):

4.88 x 4.75 in
 (123.83 x 120.65 mm)

- 360 Panel System
- Accepts the M-Series Battery Switch, M-ACR, or M-LVD

Single Circuit ON-OFF

Switches a single battery to a single load group



6004



6004, 6005, 6006



6005



6006

Selector 3 Position

Switches isolated battery banks to all loads



6008



6008

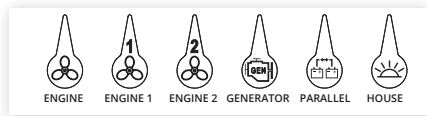

6 Circuit Label Set

Related Products



Paralleling Link Bus
1139 see table



Add-A-Battery
360 Panel page 40



M-LVD
page 42



M-ACR
page 48



Mini Add-A-Battery
page 50



Mini Add-A-Battery Plus
page 51

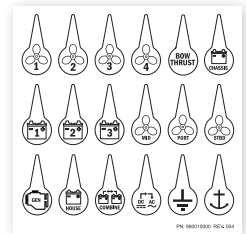

Circuit Identification
Label Kit page 160

Selector 4 Position

Switches isolated battery banks to all loads or combines battery banks to all loads



6007



6007

Dual Circuit™

Simultaneously switches two isolated battery banks or circuits. May be used to switch the positive and negative conductors for required applications.



6010



6010

⚠ WARNING

The positive and negative conductors should not be attached to the same battery switch. The only exceptions are the Dual Circuit™ Battery Switches, 6010 and 5510. Since these models have electrically isolated circuits and do not include a combine feature, they can provide disconnect to the positive and negative conductors simultaneously.

Dual Circuit Plus™

Simultaneously switches two isolated battery banks or combines battery banks to all loads. CAN NOT be used to switch positive and negative conductors because of the combine feature.



6011



6011

e-Series Battery Switches

350 Amps continuous rating for inboard gasoline or diesel engines

- Tin-plated copper studs for maximum conductivity and corrosion resistance
- Accepts up to 4/0 AWG (120 mm²) battery cables
- Studs accept 3/8" (M10) ring terminals
- 7/8" (22 mm) stud length accepts multiple cable terminals
- Blue Sea Systems one-piece terminal stud design never loosens over time
- One-piece stainless flange nuts ensure safe and secure connections
- Fits most standard Perko and Guest battery switch hole patterns
- Tactile indicator conveys knob position by feel
- Icon Circuit Identification Label Kit available 7902 - sold separately (p. 160)

Part #	9003E, 9004E	9001E, 9002E, 11001	5510E, 5511E
Cranking Rating: 30 sec.	1,200A	1,200A	700A per circuit
Intermittent Rating: 5 min.	600A	600A	525A per circuit
Continuous Rating	350A	350A	350A per circuit
Voltage Max. Operating	48V DC	32V DC	32V DC

Regulatory

CE marked, ISO 8846, UL Listed - UL 1107 electric power switches
 Meets American Boat and Yacht Council (ABYC) requirements
 Meets UL 1500 and SAE J1171 external ignition protection requirements
 IP66 - protected against powerful water jets (see inside back cover)

IGNITION PROTECTED

Part #	Description	AFD*
5510E	Dual Circuit™	--
5511E	Dual Circuit Plus™	--
9001E	Selector 4 Position	--
9002E	Selector 4 Position	Yes
9003E	Single Circuit ON-OFF	--
9004E	Single Circuit ON-OFF	Yes
11001	Selector 3 Position	Yes

* Includes Alternator Field Disconnect (AFD) which protects the diodes in the alternator in the event of the switch being switched to the OFF position while the engine is running. If the AFD is not used to protect the alternator, an LED can be connected to the AFD terminals to indicate when the battery switch is in any position but OFF.

For the full list of specifications and operation diagrams see pages 38-39
 For the wiring schematics for typical applications see pages 164-165

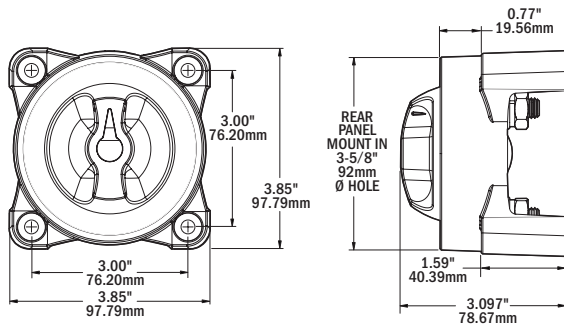

Related Products



SI-ACR
page 49



Add-A-Battery
page 50

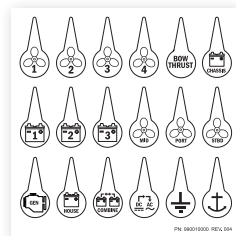

Circuit Identification
Label Kit
page 160

Mounting Options

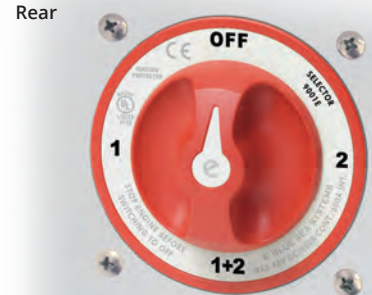

TECH tip

Choose the Dual Circuit Plus™

- Easily manage two battery banks
- When battery bank selection is not necessary
- When using sensitive electronics
- When paired with an Automatic Charging Relay (ACR)

The Dual Circuit Plus is a double pole switch that supplies power to devices connected to a specific battery bank.

House electronics are isolated from the Start bank. This preserves the Start Battery and prevents sensitive electronics from being subjected to voltage sags and spikes during starting. Designed for use with an Automatic Charging Relay (ACR) to provide simultaneous charging of two battery banks from the engine's alternator.

How to use the Dual Circuit Plus with an ACR:

1. Power is Needed - Turn the switch into the ON position.
2. No Power Needed (Storage) - Select OFF to prevent current draw.
3. Emergency Parallel (Jump Starting) - Turn the switch to the Combine Batteries position. Once the engine is running, turn the switch to the ON position.

Single Circuit ON-OFF

Switches a single battery to a single load group



9003E, 9003E*



9003E



9004E

Dual Circuit™

Simultaneously switches two isolated battery banks or circuits. May be used to switch the positive and negative conductors for required applications.



5510E
PATENTED



5510E

Selector 3 Position

Switches isolated battery banks to all loads



11001*



11001

⚠ WARNING

The positive and negative conductors should not be attached to the same battery switch. The only exceptions are the Dual Circuit™ Battery Switches, 6010 and 5510E. Since these models have electrically isolated circuits and do not include a combine feature, they can provide disconnect to the positive and negative conductors simultaneously.

Dual Circuit Plus™

Simultaneously switches two isolated battery banks or combines battery banks to all loads. CAN NOT be used to switch positive and negative conductors because of the combine feature.



5511E
PATENTED



5511E

Selector 4 Position

Switches isolated battery banks to all loads or combines battery banks to all loads



9001E, 9002E*



9001E



9002E

TECH tip™

One Piece Stud

<p>Blue Sea Systems ONE PIECE STUD Can never loosen over time</p> <p>Cold formed terminal 7/8" (22 mm) stud length Tin-plated electrical copper</p>	<p>Competitors TWO PIECE STUD Can loosen and create a poor connection</p> <p>Vibration may loosen nut 1/2" (12.70 mm) stud length</p>
--	--

* Includes Alternator Field Disconnect (AFD)

HD-Series Battery Switches

Up to 600 Amps continuous rating for large diesel engines

- Tin-plated copper studs for maximum conductivity and corrosion resistance
- Accepts up to 4/0 AWG (120 mm²) battery cables
- Studs accept 1/2" (M12) ring terminals
- 7/8" (22 mm) stud length accepts multiple cable terminals
- Blue Sea Systems one-piece terminal stud design never loosens over time
- One-piece stainless flange nuts ensure safe and secure connections
- Fits most Perko and Guest low amperage battery switch hole patterns
- Case design allows surface or rear mounting options
- Tactile indicator conveys knob position by feel
- Icon Circuit Identification Label Kit available 7902 - sold separately (p. 160)

Part #	3000, 3001	3002, 3003, 11003
Cranking Rating: 30 sec.	1,750A	1,600A
Intermittent Rating: 5 min.	900A	700A
Continuous Rating	600A	500A
Voltage Max. Operating	32V DC	32V DC

Regulatory

CE marked, ISO 8846, UL Listed - UL 1107 electric power switches
 Meets American Boat and Yacht Council (ABYC) requirements
 Meets UL 1500 and SAE J1171 external ignition protection requirements
 IP66 - protected against powerful water jets (see inside back cover)

IGNITION PROTECTED

Part #	Description	AFD*
3000	Single Circuit ON-OFF	--
3001	Single Circuit ON-OFF	Yes
3002	Selector 4 Position	--
3003	Selector 4 Position	Yes
11003	Selector 3 Position	Yes

* Includes Alternator Field Disconnect (AFD) which protects the diodes in the alternator in the event of the switch being switched to the OFF position while the engine is running. If the AFD is not used to protect the alternator, an LED can be connected to the AFD terminals to indicate when the battery switch is in any position but OFF.

For the full list of specifications and operation diagrams see pages 38-39
 For the wiring schematics for typical applications see pages 164-165

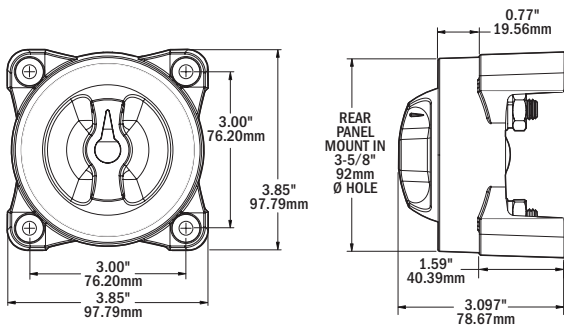

Mounting Options

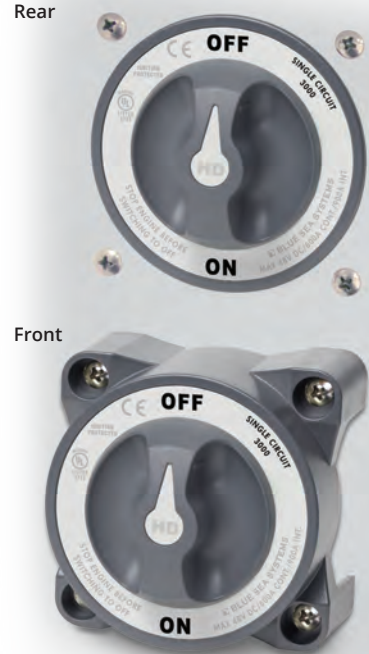

Related Products

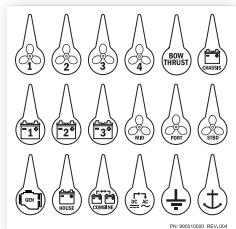

Circuit Identification Label Kit page 160



Single Circuit ON-OFF

Switches a single battery to a single load group



3000, 3001*



3000



3001

Selector 4 Position

Switches isolated battery banks to all loads or combines battery banks to all loads



3002, 3003*



3002



3003

Selector 3 Position

Switches isolated battery banks to all loads



11003*



11003

TECH tip™

HD-Series Connections

3000 and 3001 HD-Series ON-OFF battery switches have three studs; one stud for the battery connections and two studs for the common load terminations.

3002 and 3003 HD-Series Selector battery switches also have three studs; but the configuration is different with one stud for Battery 1, one stud for Battery 2, and one stud for the common load terminations.

3000 and 3001 Connections

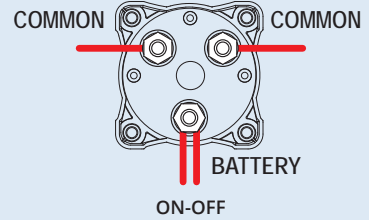

3002, 3003, and 11003 Connections

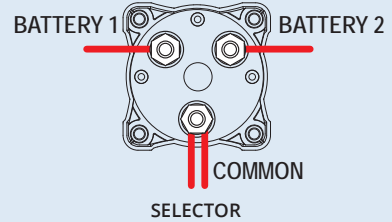

SeaForce IX builds custom sport fishing and cruising yachts which rely on Blue Sea Systems HD Heavy Duty Battery Switches for battery management in the engine room.

* Includes Alternator Field Disconnect (AFD)

Manual Battery Switch Specification Table

Switch Type	Single Circuit ON-OFF			Selector 3 Position					
Function	Switches a single battery to a single load group			Switches either isolated battery bank to loads					
Switch Family	m-Series	e-Series	HD-Series	m-Series	e-Series	HD-Series			
Part #	6004	6005	6006	9003E, 9004E*	3000, 3001*	6008	11001	11003	
Page Number	32			34	36	32			
Battery Inputs	1			2			2		
Switch Positions	2			3			3		
Battery Combine	--			--			--		
Make Before Break Contact	N/A			N/A			N/A		
Cranking Rating (30 sec.)	900A			1,200A	1,750A	900A	1,200A	1,600A	
Intermittent Rating (5 min.)	500A			600A	900A	500A	600A	700A	
Continuous Rating	300A			350A	600A	300A	350A	500A	
Voltage Maximum Operating	48V DC			48V DC	32V DC	32V DC	32V DC		
Width in (mm)	2.83" (72 mm)			3.85" (98 mm)			2.83" (72 mm)		
Height in (mm)	2.83" (72 mm)			3.85" (98 mm)			2.83" (72 mm)		
Mounting Centers	2.18" (55 mm)			3.00" (76 mm)			2.18" (55 mm)		
Mounting Hardware	#10 (M5) Screws			1/4" (M6) Screws			#10 (M5) Screws		
Terminal Stud Size	3/8"-16 (M10)			1/2" (M12)			3/8"-16 (M10)	3/8"-16 (M10)	1/2" (M12)
Terminal Stud Length	7/8" (22 mm)			7/8" (22 mm)			7/8" (22 mm)		
Max. Terminal Stud Torque	120 in-lb (13.56 N-m)			140 in-lb (15.82 N-m)	220 in-lb (24.86 N-m)	120 in-lb (13.56 N-m)	140 in-lb (15.82 N-m)	220 in-lb (24.86 N-m)	
Terminal Stud Material	Tin-plated copper			Tin-plated copper			Tin-plated copper		
Cable Size to Meet Ratings ‡	4/0 AWG (120 mm²)			4/0 AWG (120 mm²)			4/0 AWG (120 mm²)		
Cable Clearance for 4/0 Cables	1.12" (28.4 mm)			1.10" (27.9 mm)			1.12" (28.4 mm)	1.10" (27.9 mm)	
Ignition Protected	UL 1500, SAE J1171			UL 1500, SAE J1171			UL 1500, SAE J1171		
Ingress Protected	IP66 - protected against powerful water jets			IP66 - protected against powerful water jets			IP66 - protected against powerful water jets		

With Lockout



These diagrams are intended for reference of how the switches operate and are not wiring diagrams. Consult an ABYC certified marine electrical professional for system design and circuit protection.

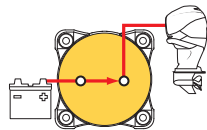

Switch set to ON

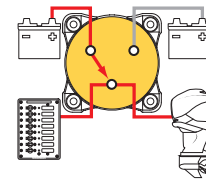



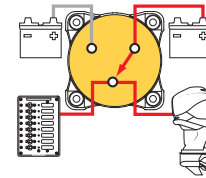



Switch set to 1



Switch set to 2

* Alternator Field Disconnect (AFD) protects the diodes in the alternator in the event of the switch being switched to the OFF position while the engine is running. If the AFD is not used to protect the alternator, an LED can be connected to the AFD terminals to indicate when the battery switch is in any position but OFF.

‡ Reducing cable size will reduce current rating

Selector 4 Position			Dual Circuit™		Dual Circuit Plus™	
Switches isolated battery banks to all loads or combines battery banks to all loads			Simultaneously switches two isolated battery banks		Simultaneously switches two isolated battery banks or combines battery banks to all loads	
m-Series	e-Series	HD-Series	m-Series	e-Series	m-Series	e-Series
						
6007	9001E, 9002E*	3002, 3003*	6010	5510E	6011	5511E
32	34	36	32	34	32	34
	2			2		2
	4			2		3
	Yes			--		Yes
	Yes			--		Yes
900A	1,200A	1,600A	675A per circuit	700A per circuit	675A per circuit	700A per circuit
500A	600A	700A	450A per circuit	525A per circuit	450A per circuit	525A per circuit
300A	350A	500A	300A per circuit	350A per circuit	300A per circuit	350A per circuit
	32V DC			32V DC		32V DC
2.83" (72 mm)	3.85" (98 mm)		2.83" (72 mm)	3.85" (98 mm)	2.83" (72 mm)	3.85" (98 mm)
2.83" (72 mm)	3.85" (98 mm)		2.83" (72 mm)	3.85" (98 mm)	2.83" (72 mm)	3.85" (98 mm)
2.18" (55 mm)	3.00" (76 mm)		2.18" (55 mm)	3.00" (76 mm)	2.18" (55 mm)	3.00" (76 mm)
#10 (M5) Screws	1/4" (M6) Screws		#10 (M5) Screws	1/4" (M6) Screws	#10 (M5) Screws	1/4" (M6) Screws
3/8"-16 (M10)	3/8"-16 (M10)	1/2" (M12)	3/8"-16 (M10)		3/8"-16 (M10)	
	7/8" (22 mm)		7/8" (22 mm)		7/8" (22 mm)	
120 in-lb (13.56 N-m)	140 in-lb (15.82 N-m)	220 in-lb (24.86 N-m)	120 in-lb (13.56 N-m)	140 in-lb (15.82 N-m)	120 in-lb (13.56 N-m)	140 in-lb (15.82 N-m)
	Tin-plated copper			Tin-plated copper		Tin-plated copper
	4/0 AWG (120 mm²)			4/0 AWG (120 mm²)		4/0 AWG (120 mm²)
1.12" (28.4 mm)	1.10" (27.9 mm)		1.12" (28.4 mm)	1.10" (27.9 mm)	1.12" (28.4 mm)	1.10" (27.9 mm)
	UL 1500, SAE J1171			UL 1500, SAE J1171		UL 1500, SAE J1171
	IP66 - protected against powerful water jets			IP66 - protected against powerful water jets		IP66 - protected against powerful water jets

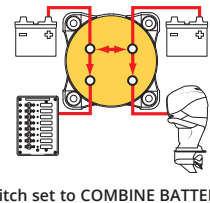
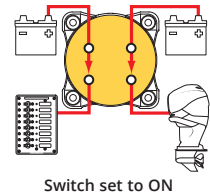
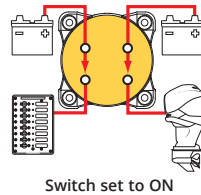
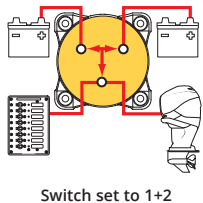
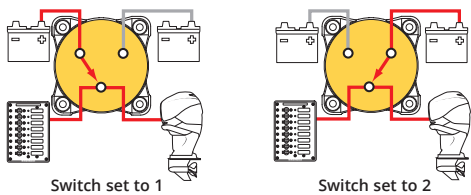

Battery Management Panels

Easily manage multiple battery bank systems

- Isolates the Start circuit from the House circuit
- Allows emergency cross connect between isolated battery banks
- Protects electronics from sags and spikes caused by engine cranking

Regulatory

Meets UL 1500 and SAE J1171 external ignition protection requirements

IGNITION PROTECTED

Related Products



M-ACR
page 34



SI-ACR
page 34

EXPANDED OFFERING



Part #	8280	8080
Description	Dual Battery Bank-Traditional Metal Panel	Dual Battery Bank-Traditional Metal Panel
Voltage Max. Operating	48V DC	48V DC
Circuit Breakers	--	1 × C-Series Flat Rocker, MAIN 100A
Battery Switch	3 × M-Series, 6006	2 × M-Series, 6006
Width x Height in (mm)	6.25 (158.75) × 7.50 (190.50)	5.25 (133.35) × 6.50 (165.10)
Depth in (mm)	2.25 (57.15)	3.00 (76.20)
Labels Included	Square Format Label Set 4218	Square Format Label Set 4218



Part #	1408	8686	8690
Description	Dual Battery Bank - 360 Panel	Dual Battery Bank - Traditional Metal Panel	Dual Battery Bank - Traditional Metal Panel
Nominal Voltage	12V DC	12V / 24V DC	12V / 24V DC
24-hour circuits	3 unswitched	2 unswitched	2 unswitched
Circuit Breakers	1 × C-Series Flat Rocker, MAIN 100A 3 × Push Button Reset-Only, BRANCH 15A	1 × C-Series Flat Rocker, MAIN 100A 2 × Push Button Reset-Only, BRANCH 15A Spare apertures for additional Flat Rocker or Push Button Reset-Only	1 × C-Series Flat Rocker, MAIN 100A 2 × Push Button Reset-Only, BRANCH 15A Spare apertures for additional Flat Rocker or Push Button Reset-Only
Battery Switch	M-Series, 6011200	M-Series, 6011	E-Series, 5511E
Width x Height in (mm)	4.88 (123.83) × 7.75 (196.85)	4.50 (114.30) × 7.50 (190.50)	5.25 (133.35) × 8.00 (203.20)
Depth in (mm)	3.50 (88.90)	3.25 (82.55)	3.00 (76.20)
LEDs	ON Indicating LEDs in all circuits	ON Indicating LEDs in all circuits	ON Indicating LEDs in all circuits
Labels Included	Square Format Label Set 4218	24-hour Round Label Set Square Format Label Set 4218	24-hour Round Label Set Square Format Label Set 4218



Part #	1494	8689	8693
Description	Mini Add-A-Battery - 360 Panel	Triple Battery Bank - Traditional Metal Panel	Triple Battery Bank - Traditional Metal Panel
Nominal Voltage	12V DC	12V / 24V DC	12V / 24V DC
24-hour circuits	--	3 unswitched	4 unswitched
Circuit Breakers	--	1 × C-Series Flat Rocker, MAIN 100A 3 × Push Button Reset-Only, BRANCH 15A Spare apertures for additional Flat Rocker or Push Button Reset-Only	1 × C-Series Flat Rocker, MAIN 100A 4 × Push Button Reset-Only, BRANCH 15A Spare apertures for additional Flat Rocker or Push Button Reset-Only
Battery Switch	M-Series, 6011	2 × M-Series, 6011	2 × E-Series, 5511E
Automatic Charging Relay	M-ACR, 7601	--	--
Width x Height in (mm)	4.88 (123.83) × 7.75 (196.85)	7.25 (184.15) × 8.00 (203.20)	10.50 (266.70) × 8.00 (203.20)
Depth in (mm)	3.25 (82.55)	3.25 (82.55)	3.50 (88.90)
LEDs	--	ON Indicating LEDs in all circuits	ON Indicating LEDs in all circuits
Labels Included	--	24-hour Round Label Set Square Format Label Set 4218	24-hour Round Label Set Square Format Label Set 4218

L-Series Solenoid Switches

EXPANDED OFFERING

150A or 250A switches are remotely activated using a low amp switch and smaller gauge wire

- Continuous duty, SPST - Normally Open
- Hermetically sealed contacts
- Activated by a remote ON-OFF switch 8230 (sold separately) p. 94
- Coil control circuit minimizes heating and amperage draw

Part #	7765	9012
Description	150A L-Series Solenoid Switch	250A L Series Solenoid Switch
Operating Temperature	-40°C to +85°C	-55°C to +85°C
Coil Circuit Connection	22 AWG Tinned Wire	20 AWG Tinned Wire
Voltage Nominal	12/24V DC	12/24V DC
Coil Function	Normally Open	Normally Open
Operating Current Changing State:	3.8A	3.6A
Operating Current Continuous:	0.13A @ 12V, 0.07A @ 24V	0.13A @ 12V, 0.07A @ 24V
Voltage Input	9V-36V DC	9V-36V DC
Mounting Screws	#10 or M5	#10 or M5
Mounting Screw Torque	15-30 in-lb (1.7-3.4 Nm)	15-35 in-lb (1.7-4 Nm)
Weight	0.95 lb (0.43 kg)	0.9 lb (0.41 kg)
Contact Rating:		
Continuous Rating	150A	250A (1/0 AWG Cable in 50°C ambient)
Cranking Rating (30 sec.)	--	1000A (1/0 AWG Cable in 50°C ambient)
Voltage Maximum	900V DC	800V DC
Regulatory		
CE marked		
IP67-protected against immersion up to 1 meter for 30 minutes (see inside back cover)		
9012 ONLY - Ignition protected - ISO 8846 and SAE J1171		
9012 ONLY - UL Certified - UL 508 Industrial Control Equipment		



7765
NEW



9012
IGNITION PROTECTED

9012 Wire Size and Current Ratings (50°C Ambient)

Wire Size	Cranking 30 sec.	Intermittent 5 min.	Continuous (UL 1107)
1/0 AWG	900A	275A	250A
2/0 AWG (70 mm²)	1000A	400A	300A
2× 2/0 AWG (2× 70 mm²)	1,450A	600A	450A

For the full list of specifications see page 54

TECH tip

Solenoid vs Remote Battery Switch

Solenoid: An electronic switch with no manual control, for circuits where a manual battery disconnect is offered elsewhere in the circuit.

Remote Battery Switch: A solenoid or relay with a manual control switch allowing for switching if control circuit is compromised and for service lockout.

Related Product



ON-OFF Switch 8230
page 94

ML-Series Solenoid Switches

EXPANDED OFFERING

500A magnetic latching solenoid provides switching under load where manual control is not required



Remote Control Contura Switch included in retail package



Deutsch DTM Cable End now offered for both retail and bulk units. Other connector plugs are available for high volume OEM applications.



- Silver alloy contacts provide high reliability for switching live loads
- LED output to remotely indicate switch state - requires optional LED (p. 155) or Remote Control Contura Switch with integrated LED (included in retail package)
- 3/8"-16 tin-plated copper studs for maximum conductivity and corrosion resistance
- One-piece stainless flange nuts for safe and secure connections
- Label recesses for circuit identification
- Retail package includes Remote Control Contura Switch (p. 95)

Regulatory

CE marked, meets ISO 8846 and SAE J1171 external ignition protection requirements IP66 - protected against powerful water jets (see inside back cover)

IGNITION PROTECTED

Part #	Contact Voltage	Control Voltage	Control Signal	Cable End
7701	0-64V	9-16V	12V Momentary	Stripped Wire
7701100	0-64V	9-16V	12V Momentary	Deutsch DTM
7703	0-64V	18-32V	24V Momentary	Stripped Wire
7703100	0-64V	18-32V	24V Momentary	Deutsch DTM
7718	NEW 9-16V	9-16V	12V Continuous	Stripped Wire
7718100	NEW 9-16V	9-16V	12V Continuous	Deutsch DTM
7719	NEW 18-32V	18-32V	24V Continuous	Stripped Wire
7719100	NEW 18-32V	18-32V	24V Continuous	Deutsch DTM

Wire Size and Current Ratings

Wire Size	Cranking 30 sec.	Intermittent 5 min.	Continuous (UL 1107)
2/0 AWG (70 mm ²)	1,000A	400A	225A
4/0 AWG (120 mm ²)	1,100A	400A	300A
2x 4/0 AWG (2x 120 mm ²)	1,450A	700A	500A

For the full list of specifications see page 54

For the dimensioned drawing see page 45

Related Products



m-LVD Low Voltage Disconnect

VIDEO blueseas.com/video

Senses low battery voltage and disconnects non-critical loads, saving power to start engine



Remote Control Contura Switch included in retail package

- Status light provides warning of low voltage state prior to disconnect
- Alarm output for audible warning of low voltage state prior to disconnect (optional alarm required)
- One-piece stainless flange nuts for safe and secure connections
- Remote Control Switch functions:
 - Adjusts disconnect voltage
 - Temporarily delays circuit disconnect for 10 minutes
 - Temporarily disconnects circuits until voltage rises
 - Silences alarm (optional alarm required)
- Retail package includes Remote Control Contura Switch 7928 (p. 95)

Intermittent Rating: 5 min.	115A
Continuous Rating	65A
Nominal Voltage	12V DC
Cable Size (to meet current ratings)	6 AWG (16mm ²)
Terminal Stud Size	1/4"-20 (M6)
Disconnect Voltage	11.3V-12.1V Adjustable
Reconnect Voltage	13V DC

Regulatory
Meets ISO 8846 and SAE J1171 external ignition protection requirements

IGNITION PROTECTED

Part #	Description
7635	m-LVD Low Voltage Disconnect

For the full list of specifications see page 55

System Diagram

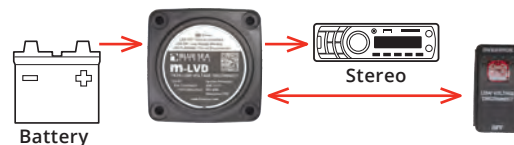

Related Products



Automatic Timer Disconnect (ATD)

Select from 4 methods to manage your batteries: Timer Disconnect, Low Voltage Disconnect, Automatic Charging Relay, or Solenoid

Timer Disconnect

- 12V signal triggers relay to connect battery power to devices
- When signal is removed the timer is activated and will disconnect devices after a preset time
- Timer ranges from 15 minutes to 4 hours
- Optional charge sense can be used instead of 12V signal to reduce wiring
- Test mode disconnects devices after 5 seconds to confirm relay and timer are operational

Low Voltage Disconnect

- Senses low battery voltage and automatically disconnects devices to save power
- Adjustable voltage setting at 11.0V, 11.5V, or 12.0V
- Low voltage setting can be used in conjunction with timer disconnect
- Low voltage will disconnect devices prior to preset time to preserve battery power

Automatic Charging Relay

- Automatically combines two battery banks for charging off a single charging source (i.e. alternator)
- Isolates batteries when charging source is not present or discharging
- Single side sensing design only monitors the voltage of the start battery
- Ideal for auxiliary batteries that are AGM or larger than the start battery

Solenoid

- 12V signal will connect or disconnect relay without any time delay



Nominal Voltage	12V DC
Input Voltage Range	9.5-16V
Continuous Rating	120A
Intermittent Rating: 5 min.	210A
Amperage Operating Current (Combine)	175mA
Amperage Operating Current (Open)	4mA
Cable Size (to meet current ratings)	1 AWG (50mm ²)
Maximum Cable Size	1/0 AWG (50mm ²)
Terminal Stud Size	3/8"-16 (M10)
Terminal Stud Torque	140 in-lb (15.82Nm)
Time Range	15 Minutes - 4 Hours

Regulatory
 CE marked, Meets ISO 8846 and SAE J1171 external ignition protection requirements
 IP67-protected against immersion up to 1 meter for 30 minutes (see inside back cover)

IGNITION PROTECTED

Part #	Description
7615	Automatic Timer Disconnect

For the full list of specifications see page 55

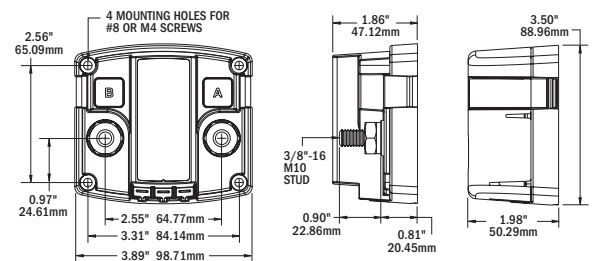

Related Products



MRBF Terminal Fuse Blocks page 70



LEDs page 155



Remote Battery Switches

A Remote Battery Switch (RBS) is a 500A relay and remote control switch connected by small gauge single wire. High amperage switching is achieved with the relay mounted next to the batteries and controlled either manually by a switch on the remote battery switch or by the remote switch mounted in an accessible location. Read the TECH Tip, Solenoid vs Remote Battery Switch RBS Explained on page 41.

The installed cost of a remote battery compared to manual battery switch may not be that different. The cost savings from eliminating long runs of expensive large gauge battery cables and replacing them with light gauge control wires can often offset the cost of a remote battery switch.

4 Position Selector Switch

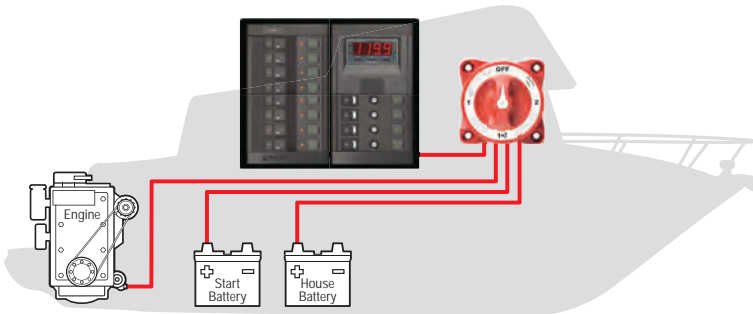

Traditional Battery Switch (40' of 4/0 AWG Cable)

- Long runs of large cable create voltage drop
- Decreased power to engine
- Increases weight
- More expensive

ML-Series Remote Battery Switches and Automatic Charging Relay

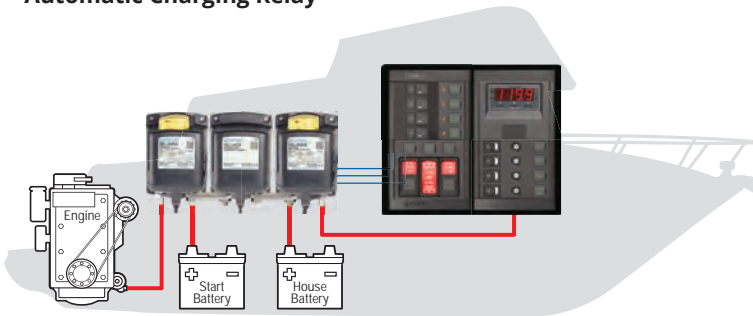

Remote Battery Management with small control wire (5' of 4/0 AWG Cable)

- Minimizes cable run and voltage drop
- Maximizes power to engine
- Reduces weight
- Saves money

TECH tip™

Mastervolt Lithium Ion Battery System

Mastervolt utilizes Blue Sea Systems ML Remote Battery Switches (ML-RBS) on their Lithium Ion Battery systems. The advanced Lithium Ion Batteries have a built in Battery Management System (BMS) with active cell balancing. The ML-RBS is utilized for its rapid ability to disconnect the batteries under full load. At any time the Mastervolt BMS can trigger the ML-RBS to safely disconnect the batteries. Once the system is restored the ML-RBS can be re-connected for quick operation. The latching operation of the ML-RBS means that no amperage is consumed during an open or closed state, which further prolongs the available power in the Lithium Ion Batteries. The override knob allows the ML-RBS to be manually disconnected for safe servicing of the battery system. With a rating of 500A continuous, the ML-RBS pairs perfectly with all of the Mastervolt Lithium Ion Batteries.

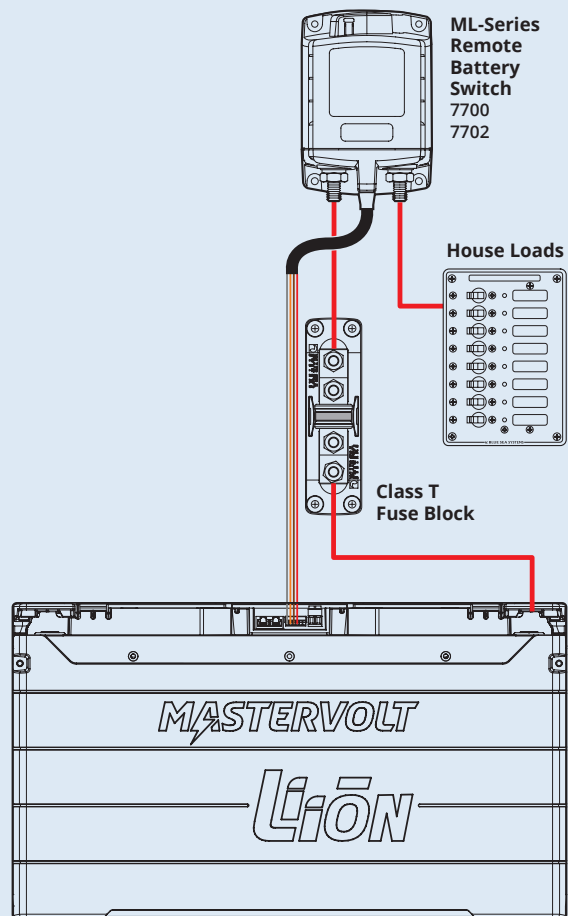

ML-Series Remote Battery Switches

500A magnetic latching switch provides high amperage switching under load, manually or from remote locations

- Silver alloy contacts provide high reliability for switching live loads
- LED output to remotely indicate switch state - requires optional LED (p. 155) or Remote Control Contura Switch with integrated LED (included in retail package)
- 3/8"-16 tin-plated copper studs for maximum conductivity and corrosion resistance
- One-piece stainless flange nuts ensure safe and secure connections
- Label recesses for circuit identification
- Retail package includes a Remote Control Contura Switch (p. 95)

Terminal Stud Size	3/8"-16 (M10)
Maximum Terminal Stud Torque	140 in-lb (15.8 N•m)
Cable Size (to meet current ratings)	4/0 AWG (120mm ²)
Terminal Ring Diameter Clearance	1.12" (28.4 mm)

Regulatory
 CE marked, meets ISO 8846 and SAE J1171 external ignition protection requirements IP66 - protected against powerful water jets (see inside back cover)

IGNITION PROTECTED

Wire Size and Current Ratings

Wire Size	Cranking 30 sec.	Intermittent 5 min.	Continuous (UL 1107)
2/0 AWG (70 mm ²)	1,000A	400A	225A
4/0 AWG (120 mm ²)	1,100A	400A	300A
2x 4/0 AWG (2x 120 mm ²)	1,450A	700A	500A

Part #	Contact Voltage	Control Voltage	Signal Voltage	Cable End
7700	0-64V	9-16V	12V Momentary	Stripped Wire
7700100	0-64V	9-16V	12V Momentary	Deutsch DTM
7702	0-64V	18-32V	24V Momentary	Stripped Wire
7702100	0-64V	18-32V	24V Momentary	Deutsch DTM
7713	9-16V	9-16V	12V Continuous	Stripped Wire
7713100	9-16V	9-16V	12V Continuous	Deutsch DTM
7717	18-32V	18-32V	24V Continuous	Stripped Wire
7717100	18-32V	18-32V	24V Continuous	Deutsch DTM
9160	Paralleling link bus			

For the full list of specifications see page page 54

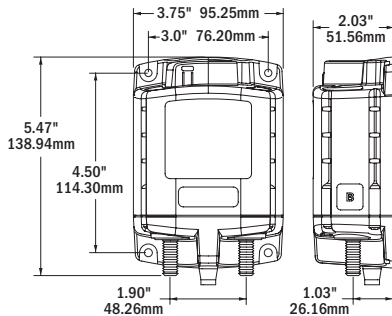

Remote Control Contura Switch included in retail package



Duetch DTM Cable End now offered for both retail and bulk units. Other connector plugs are available for high volume OEM applications.



7700



7713

TECH tip™

ML-Series Solenoid & RBS Update

A number of ML-Series Solenoids and Remote Battery Switches are now rated to 64V DC, making them ideal for use in 36V DC and 48V DC nominally-rated systems. The new 64V DC rating applies only to the contact voltage, while maintaining the existing 12V DC or 24V DC signal voltage, making them ideal for use in multi-voltage systems like solar or golf-carts. The new higher voltage rating was tested to 2,000 live-switching cycles at maximum operating voltage per UL 1107 requirements.

Related Products



Paralleling Link Bus 9160 see table



ML-Series ACR page 53



Remote Control Switch 360 Panels page 96



LEDs page 155



Stud Mount Insulators page 110

Intro to Automatic Charging Relays

Automatic Charging Relay Operation

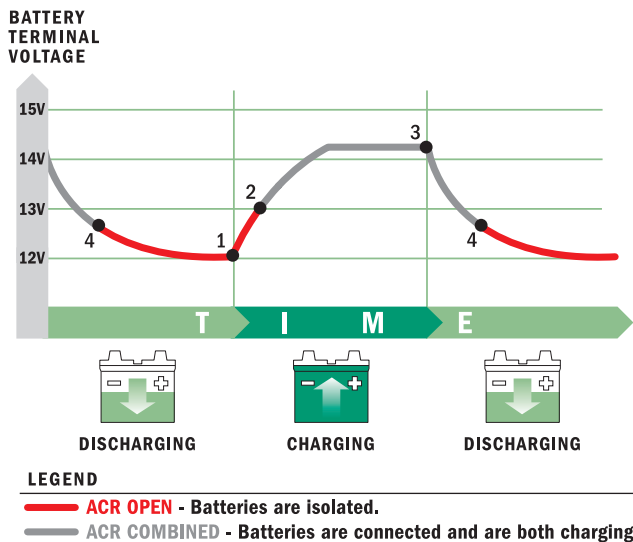

1. ACR relay is open and batteries are isolated. Voltage begins to rise slowly after engine starts or battery charger is turned on.
2. When voltage rises to COMBINE voltage 13.0V in this example, ACR relay closes, connecting and charging both batteries.
3. When engine stops or battery charger is turned off, voltage rapidly begins falling.
4. When voltage falls to ISOLATE voltage 12.75 in this example ACR relay opens, isolating batteries while discharging.



Back Cove Yachts installs the SI ACR as original equipment aboard their yachts, including the Back Cove 37.

TECH tip

Automatic Charging Relays

In a boat or vehicle with two battery banks, it is useful to be able to charge both banks while underway. Charge management devices allow two battery banks to be charged from a single source, such as an alternator, but keep batteries isolated when not charging. If one battery becomes depleted, there will be a charged bank available for emergency starting.

There are two types of charge management devices used on boats: Automatic Charging Relays (ACR) use a relay combined with a voltage sensing circuit. When a charge is being applied to a battery and the voltage rises over 13V DC, the relay closes and combines the two batteries. When the charge is taken away or the load on the battery is greater than the charging input causing the voltage to drop to 12.75V DC, the relay opens and isolates the two batteries.

Battery Isolators are one-way electrical check valves that allow current to flow to, but not from, the battery. Their disadvantage is that they use diodes, which cause a voltage drop that consumes charging energy, creates heat, and causes batteries to be undercharged. Although alternators with external voltage sensing can correct for undercharging, voltage drop and heat remain a problem.

Zero Drop Isolators have more recently been developed to address the voltage drop issue of the traditional isolator but often have a higher price than either of the other two options mentioned above.

Automatic Charging Relay vs. Battery Isolator

Automatic Charging Relay

A lower voltage drop replacement for battery isolators
.05V Drop - Batteries Fully Charged

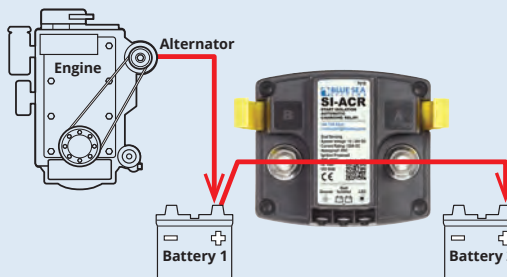

An ACR passes the current from one battery to the other

Battery Isolator

.6V Drop - Batteries Under Charged

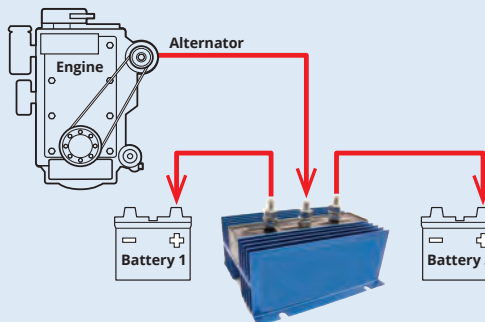

An isolator splits the current

Selection Chart

Choose the right Automatic Charging Relay for your application

1. Select an ACR that has a **CONTINUOUS** rating above the maximum alternator output rating and an **INTERMITTENT** rating that is above the largest load on the auxiliary battery.

2. Review the **PRESET ACR SETTINGS**

3. Select the ACR with the desired **PRODUCT FEATURES**



PN	7601	7611	7610	7620	7622
CONTINUOUS	65A	120A	120A	500A	500A
INTERMITTENT	115A	210A	210A	700A	700A

PRESET ACR SETTINGS

Combine Voltage

- Charge present and loads do not exceed charge input
- Voltage of either battery is $\geq 13.0V$ for 2 min.
- Relay will close, combining batteries
- Combined batteries share charge

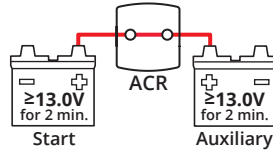

✓	✓	✓	✓	✓
---	---	---	---	---

Open Voltage

- No charge present or loads exceed charge input
- Combine voltage is $\leq 12.75V$ for 30 sec.
- Relay will open, isolating batteries
- Isolated batteries do not share charge

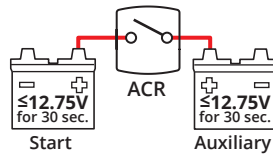

✓	✓	✓	✓	✓
---	---	---	---	---

Under Voltage Lockout

- Charge may or may not be present
- Voltage of either battery is $\leq 9.5V$ (ML-ACR 9.6V)
- Relay will not close even with charge on other battery, protecting ACR and wiring from high surge current
- Isolated batteries do not share charge

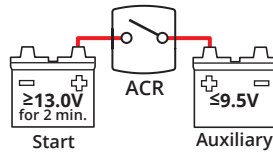

✓		✓	✓	✓
---	--	---	---	---

PRODUCT FEATURES

Auxiliary Battery Priority (optional)

Condition: Engine running

- Open voltage is lowered to 12.25V from 12.75V
- Relay remains closed longer, combining batteries, to allow use of auxiliary loads for a longer period of time

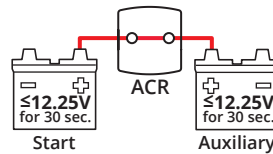

	✓			
--	---	--	--	--

Start Isolation (optional)

Condition: Engine starting

- Relay is open, isolating batteries
- Batteries are isolated to protect sensitive electronics from voltage sags and spikes

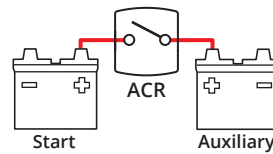

✓		✓	✓	✓
---	--	---	---	---

Start Assist

Condition: Engine starting – (Press Contura Switch)

- Relay is closed, combining batteries
- Batteries are combined to share power in the event of a low start battery

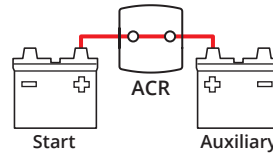

			✓	✓
--	--	--	---	---

Engine Isolation

Condition: Two engines are running

- One relay is open and one relay is closed
- Engine 1 Start and Engine 2 Start batteries are isolated to protect engine electronics
- If requested by engine manufacturer

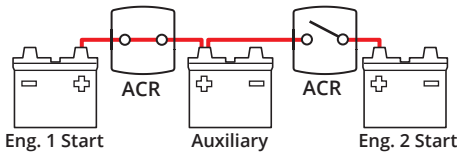

			✓	✓
--	--	--	---	---

Manual Override

Manual override knob provides an added level of safety allowing manual control of ON-OFF

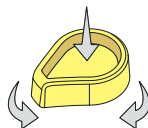

				✓
--	--	--	--	---

M-ACR Automatic Charging Relay

with optional Start Isolation

Automatically combines batteries during charging, isolates batteries when discharging and when starting engines

- 65 Amp continuous rating
- 12V/24V DC auto ranging voltage input
- Senses charging on two battery banks
- Case design allows surface, rear, or front panel mounting options
- Snap-on cover insulates terminal connections
- One-piece stainless flange nuts ensure safe and secure connections
- Integrated LED indicates ACR states
- Quick connect terminals for ground and start isolation
- Optional Start Isolation allows temporary isolation of House loads from Engine circuit during engine cranking to protect sensitive electronics from sags and spikes



Intermittent Rating: 5 min.	115A
Continuous Rating	65A
Amperage Operating Current (Combine)	90mA
Amperage Operating Current (Open)	15mA
Nominal Voltage	12V / 24V DC
Cable Size (to meet current ratings)	6 AWG (16mm ²)
Maximum Cable Size	1/0 AWG (50mm ²)
Terminal Stud Size	1/4"-20 (M6)
Terminal Stud Length	7/16" (11 mm)
Relay Contact Position	12V DC 24V DC
Combine (30 sec.)	13.6V DC 27.2V DC
Combine (2 min.)	13.0V DC 26.0V DC
Open (10 sec.)	12.35V DC 24.7V DC
Open (30 sec.)	12.75V DC 25.5V DC
Over Voltage Lockout	16.0V DC --
Under Voltage Lockout	9.5V DC 19.0V DC
Under Voltage Recovery	10.0V DC 20.0V DC

Regulatory

CE marked, ISO 8846, meets SAE J1171 external ignition protection requirements
IP67 - protected against immersion up to 1 meter for 30 minutes (see inside back cover)

IGNITION PROTECTED

Part #	Description
7601	m-ACR Automatic Charging Relay

For the full list of specifications see page 55

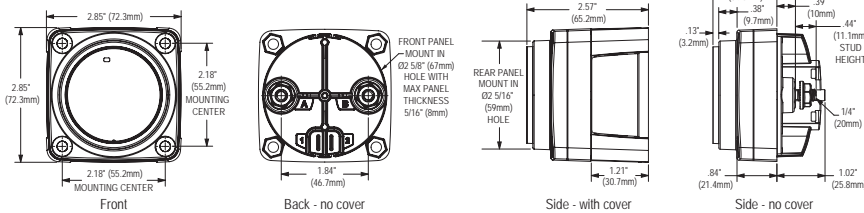

Mounting Options



Rear



Front



Surface

Related Products



M-Series Battery Switch
page 32



Mini Add-A-Battery
360 Panel
page 40



Mini Add-A-Battery
page 50



MRBF Terminal
Fuse Blocks
page 70



WeatherDeck OFF-ON
Toggle Switch
page 98

SI-ACR Automatic Charging Relay with optional Start Isolation

Automatically combines batteries during charging, isolates batteries when discharging and when starting engines

- 120A continuous rating to support high output alternators
- 12V/24V DC auto ranging voltage input
- Senses charging on two battery banks
- Side and bottom knockouts for cable connections
- Clip-on cover insulates terminal connections
- Studs accept multiple cable terminals
- One-piece stainless flange nuts ensure safe and secure connections
- Integrated LED indicates ACR status
- Quick connect terminals for ground and optional features
- Optional Start Isolation allows temporary isolation of House loads from Engine circuit during engine cranking to protect sensitive electronics from sags and spikes
- Remote LED indicates ACR states - requires optional LED (p. 155)



Intermittent Rating: 5 min.	210A
Continuous Rating	120A
Amperage Operating Current (Combine)	175mA
Amperage Operating Current (Open)	15mA
Nominal Voltage	12V / 24V DC
Cable Size (to meet current ratings)	1 AWG (50mm ²)
Maximum Cable Size	1/0 AWG (50mm ²)
Terminal Stud Size	3/8"-16 (M10)
Relay Contact Position	12V DC 24V DC
Combine (30 sec.)	13.6V DC 27.2V DC
Combine (2 min.)	13.0V DC 26.0V DC
Open (10 sec.)	12.35V DC 24.7V DC
Open (30 sec.)	12.75V DC 25.5V DC
Over Voltage Lockout	16.0V DC 30.0V DC
Under Voltage Lockout	9.5V DC 19.0V DC
Under Voltage Recovery	10.0V DC 20.0V DC
Regulatory	
CE marked, ISO 8846, meets UL 1500 and SAE J1171 external ignition protection requirements	
IP67 - protected against immersion up to 1 meter for 30 minutes (see inside back cover)	



cover off

IGNITION PROTECTED

Part #	Description
7610	SI-ACR Automatic Charging Relay

For the full list of specifications see page page 55
 For the dimensioned drawing see page page 43

Related Products



e-Series Battery Switch page 34



Add-A-Battery page 50



MRBF Terminal Fuse Blocks page 70



WeatherDeck OFF-ON Toggle Switch page 98



LEDs page 155

Mini Add-A-Battery Kit

Simplifies switching and automates charging for a 65A, two battery bank solution for outboard powered boats

- For alternators up to 65A
- Includes the m-Series Dual Circuit Plus Battery Switch 6011 (p. 32) and the m-ACR Automatic Charging Relay 7601 (p. 48)

m-Series Dual Circuit Plus™ Battery Switch

- Switches two battery banks simultaneously while maintaining battery bank isolation
- Can combine two battery banks in the event of a low start battery
- IP66 - protected against powerful water jets (see inside back cover)

m-ACR Automatic Charging Relay

- Automatically combines battery banks when charging and isolates when discharging
- Start isolation protects sensitive electronics
- Dual Sensing senses charge on two battery banks
- IP67 - protected against immersion up to 1 meter for 30 minutes (see inside back cover)

Part #	Description	Retail Package
7649	Mini Add-A-Battery Kit	Clam
7649003	Mini Add-A-Battery Kit	Box

Add-A-Battery Kit

Simplifies switching and automates charging for a 120A, two battery bank solution for inboard and outboard powered boats

- For alternators up to 120A
- Includes the e-Series Dual Circuit Plus Battery Switch 5511E (p. 34) and the SI-ACR Automatic Charging Relay 7610 (p. 49)

e-Series Dual Circuit Plus™ Battery Switch

- Switches two battery banks simultaneously while maintaining battery bank isolation
- Can combine two battery banks in the event of a low start battery
- IP66 - protected against powerful water jets (see inside back cover)

SI-ACR Automatic Charging Relay

- Automatically combines battery banks when charging and isolates when discharging
- Start isolation protects sensitive electronics
- Dual Sensing senses charge on two battery banks
- IP67 - protected against immersion up to 1 meter for 30 minutes (see inside back cover)

Part #	Description	Retail Package
7650	Add-A-Battery Kit	Clam
7650003	Add-A-Battery Kit	Box

Alternators up to 65A



7649

VIDEO bluesease.com/video

IGNITION PROTECTED

Alternators up to 120A



7650

VIDEO bluesease.com/video

IGNITION PROTECTED

Related Products



Related Products



TECH tip™

Add-A-Battery Kits Explained

Avoid the inconvenience and cost of a tow by adding a second battery to your electrical system.

The Add-A-Battery Kits include a Dual Circuit Plus™ Battery Switch and an Automatic Charging Relay. These components simplify switching and automate charging. Simply turn the battery switch ON when you arrive and OFF when you leave.

Adding a second battery prevents getting stranded with a dead battery by isolating the Start battery from the House loads that can quickly discharge a battery. The Add-A-Battery Kits offer a simple way to control switching with the Dual Circuit Plus™ Battery Switch and automatically shares a single source of charging between two batteries with the Automatic Charging Relay.

ENGINE ON

ACR combines batteries sharing the charge with House battery

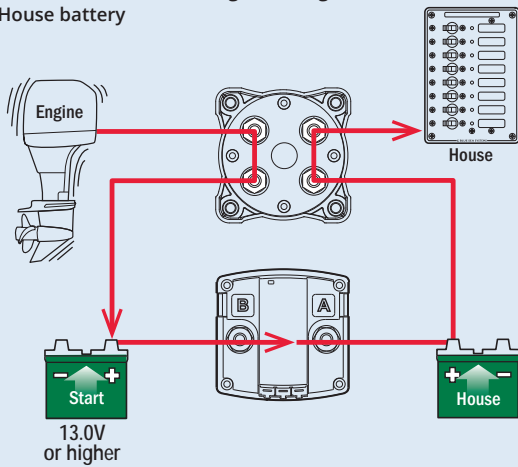

ENGINE OFF

ACR isolates batteries when discharging and when starting engine

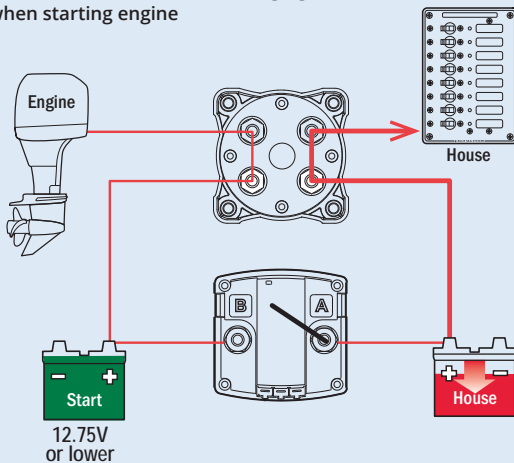

DC Current

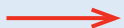

The diagrams above illustrate how the 7650 and 7649 Add-A-Battery Kits work and are intended for reference only. Consult an ABYC certified marine electrical professional for system design and circuit protection.

Mini Add-A-Battery Plus Kits

A complete small boat battery management system. Charge two batteries at or away from the dock.

- For alternators up to 65A
- Includes an m-Series Dual Circuit Plus™ Battery Switch 6011 (p. 32) and a BatteryLink® Charger (p. 24)

m-Series Dual Circuit Plus Battery Switch

- Switches two battery banks simultaneously while maintaining battery bank isolation
- Can combine two battery banks in the event of a low start battery
- IP66 - protected against powerful water jets (see inside back cover)

BatteryLink Charger

- Integrated ACR provides DC charging from engine alternator
- AC plug-in while at the dock
- Battery temperature compensation prolongs battery life
- Includes a remote LED indicator
- Start isolation protects sensitive electronics
- IP67 - protected against immersion up to 1 meter for 30 minutes (see inside back cover)

Part #	Description	Plug Style
7655	Mini Add-A-Battery Plus Kit	North American: NEMA 5-15P
7654	Mini Add-A-Battery Plus Kit	European: CEE 7/7
7653	Mini Add-A-Battery Plus Kit	Bare wire



7655

IGNITION PROTECTED

For the AC & DC Battery Charging Explained TECH Tip see page 24

Related Products



BatteryLink Chargers page 24



m-Series Battery Switch page 32

BatteryLink® Automatic Charging Relay (ACR)

with optional Auxiliary Battery Priority

Automatically shares single source of charge with Auxiliary Battery

- 120A continuous rating to support high output alternators
- 12V/24V DC auto ranging voltage input
- Senses charging on two battery banks
- Side and bottom knockouts for cable connections
- Clip-on cover insulates terminal connections
- Studs accept multiple cable terminals
- One-piece stainless flange nuts ensure safe and secure connections
- Integrated LED indicates ACR status
- Quick connect terminals for ground and optional features
- Optional Auxiliary Battery Priority connection shares the alternator charge with the Auxiliary battery longer when the engine is running to allow the use of auxiliary loads for an extended period of time
- Remote LED remotely indicates ACR states - requires optional LED (p. 155)



Intermittent Rating: 5 min.	210A
Continuous Rating	120A
Amperage Operating Current (Combine)	175mA
Amperage Operating Current (Open)	15mA
Nominal Voltage	12V / 24V DC
Cable Size (to meet current ratings)	1 AWG (50mm ²)
Maximum Cable Size	1/0 AWG (50mm ²)
Terminal Stud Size	3/8"-16 (M10)
Maximum Battery Size	850 CCA
Relay Contact Position	12V DC 24V DC
Combine (30 sec.)	13.6V DC 27.2V DC
Combine (2 min.)	13.0V DC 26.0V DC
Open Low (30 sec.)	12.75V DC 25.5V DC
Over Voltage Lockout	16.0V DC --
Optional Auxiliary Priority	
Open Low (30 sec.)	12.25V DC 24.5V DC
Regulatory	
CE marked, ISO 8846, UL 1500, meets SAE J1171 external ignition protection requirements	
IP67 - protected against immersion up to 1 meter for 30 minutes (see inside back cover)	



cover off

IGNITION PROTECTED

Part #	Description
7611	BatteryLink ACR

For the full list of specifications see page 55
For the dimension drawing see page 43

Related Products



E-Series Battery Switch page 34



MRBF Terminal Fuse Blocks page 70



WeatherDeck OFF-ON Toggle Switch page 98



LEDs page 155



ML-Series Automatic Charging Relays (ACR)

500 Amp magnetic latching relay automatically combines batteries during charging and isolates batteries when discharging and when starting engine

- Magnetic Latching (ML) relay draws very low current in the ON state
- Start Isolation (SI) can be configured for temporary isolation of House loads from Engine circuit during engine cranking to protect sensitive electronics
- Engine Isolation (EI) can be configured for isolation of two engines while both are running to protect engine electronics and maximize alternator output
- Manual override knob provides an added level of safety allowing control with or without power and offering LOCKED OFF capability for servicing
- Senses charging on two battery banks
- LED output to remotely indicate switch state - requires optional LED (p. 155) or Remote Control Contura Switch with integrated LED (included in retail package)
- 3/8"-16 tin-plated copper studs for maximum conductivity and corrosion resistance
- One-piece stainless flange nuts ensure safe and secure connections
- Silver alloy contacts provide high reliability for live switching
- Retail packaging includes a Remote Control Contura Switch (p. 95)

Live Current Switching		300A @ 12V DC-10,000 Cycles	
Relay Contact Position		12V DC	24V DC
Combine	(30 sec.)	13.5V DC	27.0V DC
Combine	(2 min.)	13.0V DC	26.0V DC
Open	(10 sec.)	12.35V DC	24.7V DC
Open Low	(30 sec.)	12.75V DC	25.5V DC
Over Voltage Lockout		16.2V DC	32.4V DC
Under Voltage Lockout		9.6V DC	19.2V DC
Under Voltage Recovery		10.0V DC	20.0V DC

Regulatory
 CE marked, meets ISO 8846 and SAE J1171 external ignition protection requirements
 IP66 - protected against powerful water jets (see inside back cover)

IGNITION PROTECTED

Wire Size and Current Ratings

Wire Size	Cranking 30 sec.	Intermittent 5 min.	Continuous (UL 1107)
2/0 AWG (70 mm ²)	1,000A	400A	225A
4/0 AWG (120 mm ²)	1,100A	400A	300A
2x 4/0 AWG (2x 120 mm ²)	1,450A	700A	500A

Part #	Coil Volts	Cable End	Manual Control
7620	12V DC	Stripped Wire	No
7620100	12V DC	Deutsch DTM	No
7622	12V DC	Stripped Wire	Yes
7622100	12V DC	Deutsch DTM	Yes
7621	24V DC	Stripped Wire	No
7621100	24V DC	Deutsch DTM	No
7623	24V DC	Stripped Wire	Yes
7623100	24V DC	Deutsch DTM	Yes

For the full list of specifications see page 55
 For the dimension drawing see page 45

Related Products



ML-Series Remote Battery Switches
page 45



MRBF Terminal Fuse Blocks
page 70



Remote Control Switch 360 Panels
page 96



Paralleling Link Bus
page 45 (see table)



LEDs
page 155



Stud Mount Insulators
page 110



7622



Remote Control Contura Switch included in retail package



7620











Duetch DTM Cable End now offered for both retail and bulk units. Other connector plugs are available for high volume OEM applications.

Solenoid and Remote Battery Switch Specification Table

Product Type	Solenoid Switches						Remote Battery Switches (RBS)			
Function	Provides high-amp switching						Provides high-amp switching with manual override			
Product	L-Series Solenoid		ML-Series Solenoid				ML-Series RBS			
										
Part #	9012	7765	7701	7703	7718	7719	7700	7702	7713	7717
Page Number	41	41	42	42	42	42	42	45	45	45
Manual Control	--	--	--	--	--	--	Yes	Yes	Yes	Yes
Nominal Voltage	12V/24V DC	12V/24V DC	12V DC	24V DC	12V DC	24V DC	12V DC	24V DC	12V DC	24V DC
Operating Voltage (contacts)	0-800V	0-900V	0-64V	0-64V	9-16V	18-32V	0-64V	0-64V	9-16V	18-32V
Control Voltage	9-36V	9-36V	9-16V	18-32V	9-16V	18-32V	9-16V	18-32V	9-16V	18-32V
Cranking Rating (30 sec.)	1,000A DC	--	1,450A DC		1,450A DC		1,450A DC			
Intermittent Rating (5 min.)	275A DC	225A DC	700A DC		700A DC		700A DC			
Continuous Rating	250A DC	150A DC	500A DC		500A DC		500A DC			
Amperage Operating Current - continuous @ 25°C nominal VDC	0.13A @ 12V DC 0.07A @ 24V DC	0.13A @ 12V DC 0.07A @ 24V DC	0mA		< 13mA		0mA		< 13mA	
Amperage Operating Current - when changing state	3.6A DC	3.8A DC	< 7.0A DC	< 4.0A DC	< 7.0A DC	< 4.0A DC	< 7.0A DC	< 4.0A DC	< 7.0A DC	< 4.0A DC
Switching Cycles	1,000,000	200,000	100,000		100,000		100,000			
Live Switching Cycles	40,000 @ 24V, 250A 1,500 @ 450V, 250A 1,000 @ 800V, 250A	80,000 @ 28V, 150A 10,000 @ 450V, 150A 300 @ 900V, 150A	10,000 @ 12V, 300A 10,000 @ 24V, 150A 2000 @ 48V, 100A		10,000 @ 12V, 300A	10,000 @ 24V, 150A	10,000 @ 12V, 300A 10,000 @ 24V, 150A 2000 @ 48V, 100A		10,000 @ 12V, 300A	10,000 @ 24V, 150A
Control Signal	Continuous	Continuous	Momentary		Continuous		Momentary		Continuous	
Coil Function	Normally Open	Normally Open	Magnetic Latching Bi-Stable		Magnetic Latching Auto-Releasing		Magnetic Latching Bi-Stable		Magnetic Latching Auto-Releasing	
Remote Control Switch Included	--	--	2145 SPDT (ON)-OFF-(ON)		2155 SPDT ON-ON		2145 SPDT (ON)-OFF-(ON)		2155 SPDT ON-ON	
Control Circuit Connection	Tinned Wire	Tinned Wire	Tinned Wire or Deutsch Connector		Tinned Wire or Deutsch Connector		Tinned Wire or Deutsch Connector		Tinned Wire or Deutsch Connector	
Mounting	#10 or M5	#10 or M5	#10 or M5		#10 or M5		#10 or M5		#10 or M5	
Terminal Stud Size	5/16" (M8)	5/16" (M8)	3/8"-16 (M10)		3/8"-16 (M10)		3/8"-16 (M10)		3/8"-16 (M10)	
Terminal Stud Length	5/8" (16 mm)	5/8" (16 mm)	7/8" (22 mm)		7/8" (22 mm)		7/8" (22 mm)		7/8" (22 mm)	
Maximum Terminal Stud Torque	90 in-lb (10.0 Nm)	90 in-lb (10.0 Nm)	140 in-lb (15.5 Nm)		140 in-lb (15.5 Nm)		140 in-lb (15.5 Nm)		140 in-lb (15.5 Nm)	
Cable Size to Meet Ratings	1/0 AWG (50 mm ²)	--	4/0 AWG (120 mm ²) × 2		4/0 AWG (120 mm ²) × 2		4/0 AWG (120 mm ²) × 2		4/0 AWG (120 mm ²) × 2	
Terminal Ring Diameter Clearance	not rated	not rated	1.12" (28.4 mm)		1.12" (28.4 mm)		1.12" (28.4 mm)		1.12" (28.4 mm)	
Width	3.17" (80.5 mm)	3.18" (80.8 mm)	3.75" (95.2 mm)		3.75" (95.2 mm)		3.75" (95.2 mm)		3.75" (95.2 mm)	
Height	2.21" (56.1 mm)	2.29" (58.2 mm)	5.47" (138.9 mm)		5.47" (138.9 mm)		5.47" (138.9 mm)		5.47" (138.9 mm)	
Depth	2.86" (72.6 mm)	2.90" (73.7 mm)	2.03" (51.6 mm)		2.03" (51.6 mm)		2.03" (51.6 mm)		2.03" (51.6 mm)	
Ignition Protected	ISO 8846 SAE J1171	--	ISO 8846, SAE J1171		ISO 8846, SAE J1171		ISO 8846, SAE J1171			
Ingress Protected (see inside back cover)	IP67	IP67	IP66		IP66		IP66			

Non-Critical Load Disconnect and Automatic Charging Relay Specification Table

Non-critical Load Disconnects		Automatic Charging Relays (ACR)						
Disconnects non-critical loads after a set voltage	Disconnects non-critical loads after a set time	Allows charging of multiple batteries from a single charge source						
m-LVD	ATD	m-ACR	SI-ACR	BatteryLink ACR	ML-Series ACR			
								
7635	7615	7601	7610	7611	7620	7622	7621	7623
42	43	48	49	52	53	53	53	53
--	--	--	--	--	--	Yes	--	Yes
12V DC	12V DC	12V/24V DC	12V/24V DC	12V/24V DC	12V DC	12V DC	24V DC	24V DC
--	--	--	--	--	--	--	--	--
				--				
		--			1,450A DC			
115A DC	210A DC	115A DC	210A DC		700A DC			
65A DC	120A DC	65A DC	120A DC		500A DC			
4mA open 95mA connected	15mA open 175mA connected	15mA open 90mA combined	15mA open 175mA combined		< 13mA			
		--			< 7.0A DC		< 4.0A DC	
		--			100,000			
				--				
				--				
		Normally Open			Magnetic Latching Bi-Stable			
SPDT (ON)-OFF-(ON)	--			2146 SPDT ON-OFF-ON				
		1/4" Quick Connect			Tinned Wire or Deutsch Connector			
#10 or M5	#8 or M4	#10 or M5	#8 or M4	#10 or M5				
1/4"-20 (M6)	3/8"-16 (M10)	1/4"-20 (M6)	3/8"-16 (M10)	3/8"-16 (M10)				
7/16" (11 mm)	7/8" (22 mm)	7/16" (11 mm)	7/8" (22 mm)	7/8" (22 mm)				
60 in-lb (6.8 Nm)	140 in-lb (15.8 Nm)	60 in-lb (6.8 Nm)	140 in-lb (15.8 Nm)	140 in-lb (15.8 Nm)				
6 AWG (16 mm ²)	1/0 AWG (50 mm ²)	6 AWG (16 mm ²)	1/0 AWG (50 mm ²)	4/0 AWG (120 mm ²) × 2				
0.80" (20.3 mm)	1.05" (26.7 mm)	0.80" (20.3 mm)	1.05" (26.7 mm)	1.12" (28.4 mm)				
2.85" (72.3 mm)	3.89" (98.7 mm)	2.85" (72.3 mm)	3.89" (98.7 mm)	3.75" (95.3 mm)				
2.85" (72.3 mm)	3.50" (89.0 mm)	2.85" (72.3 mm)	3.50" (89.0 mm)	5.47" (138.9 mm)				
2.57" (65.2 mm)	1.98" (50.3 mm)	2.57" (65.2 mm)	1.98" (50.3 mm)	2.03" (51.6 mm)				
ISO 8846 SAE J1171	ISO 8846 SAE J1171	ISO 8846 SAE J1171	ISO 8846, UL1500 SAE J1171	ISO 8846, SAE J1171				
IP67	IP66	IP67		IP66				

CIRCUIT PROTECTION & SWITCHES

Fuses

58



Available in amperage ranges of .25A in the smallest glass fuse to 750A in a fuse intended to provide DC Main protection on large battery banks.

Fuses Holders

62



In-line fuse holders are compact and hold a single low-amperage fuse.

Fuse Blocks

63



Fuse blocks mount to a solid surface and may hold a single fuse or multiple fuses.

ST-Blade Water-Resistant Fuse Block

64

NEW



Provides water-resistant circuit protection for ATO/ATC fuses & circuit breakers in a compact footprint. The single side nesting design allows for wire entry from one side to maximize space.

Circuit Breaker Blocks

76



Innovative block designed for Push-Button CLB Circuit Breakers with quick connect terminals. Easily snap circuit breakers into place. Common Source versions eliminate the need for a wiring harness.



CIRCUIT PROTECTION & SWITCHES

ATO/ATC-Style Circuit Breakers

79



Use a manually resettable circuit breaker instead of an ATO or ATC fuse

Thermal Circuit Breakers

80



Circuit breakers offer the ability to reset instead of replace the device after a fault. Available circuit breakers include styles with and without switching, and for DC and AC systems.

UL-489 Circuit Breakers

83



Circuit breakers offer the ability to reset instead of replace the device after a fault. Available circuit breakers include styles with and without switching, and for DC and AC systems.

Surface Mount Systems

90



Panel enclosure for ELCI Main circuit breakers and other large frame devices. Meets ABYC E-11 when used with an ELCI Main circuit breaker and mounted within 10 feet of the shore power inlet.

Switches

94



Switching options for different apertures and configurations.



Best practices recommend every wire, except the engine starting circuit, have circuit protection.

When excessive current flows in an electrical circuit, wire insulation can melt and possibly start a fire. Circuit breakers and fuses protect the wire in electrical circuits. Blue Sea Systems' selection of circuit breakers, fuses, fuse holders, and fuse blocks offer a range of choices for main and branch circuit protection. To help in the selection process, Blue Sea Systems developed the Circuit Wizard to determine the correct size wire and fuse or circuit breaker for the application. Go to circuitwizard.blueseasystems.com to download the app.

TECH tip™

Color Coding

The circuit protection color coded packaging matches fuses with the corresponding fuse holder or fuse block for easier component selection. Look for color rectangles on the packaging of each fuse holder and fuse block, and match the color with the fuse packaging to find the correct fuse type. Some fuse blocks require two different fuse types.



CIRCUIT wizard™

Determine Your Circuit Requirements

Use the Blue Sea Systems Circuit Wizard to select the correct wire size, circuit breaker, or fuse and fuse holder. www.circuitwizard.blueseas.com



Scan to use the Circuit Wizard



Circuit Wizard App



GMA® and AGA® Fuses

Fast-acting glass fuses

- Visible indication of blown condition
- Used for 12V/24V DC applications

Blow Time Delay See blueseas.com



GMA®



AGA®

Blow Time Delay See blueseas.com

Part #	Fuse Type	Amps	DC Volts	AC Volts	Retail Pack
5280	GMA	1A	24V DC	250V AC	3
5281	GMA	2A	24V DC	250V AC	3
5282	GMA	3A	24V DC	250V AC	3
5283	GMA	5A	24V DC	125V AC	3
5284	GMA	7A	24V DC	125V AC	3
5285	GMA	10A	24V DC	125V AC	3
5275	AGA	20A	32V DC	--	5

Protect your boat with the correct size wire and fuse, see p. 161

AGC® and MDL® Fuses

AGC – Fast-acting glass fuses

MDL – Slow blow glass fuses

- Visible indication of blown condition

Voltage Max. Operating 32V DC / See table for AC

Blow Time Delay See blueseas.com



AGC®



MDL®

AGC Fuses

Part #	Amps	Volts	Retail Pack
5201	.25A	250V AC	5
5202	.5A	250V AC	5
5204	1A	250V AC	5
5204100	1A	250V AC	25
5205	1.5A	250V AC	5
5206	2A	250V AC	5
5206100	2A	250V AC	25
5207	2.5A	250V AC	5
5208	3A	250V AC	5
5208100	3A	250V AC	25
5209	4A	250V AC	5
5210	5A	250V AC	5
5210100	5A	250V AC	25
5211	6A	250V AC	5
5212	7A	250V AC	5
5213	7.5A	250V AC	5
5213100	7.5A	250V AC	25
5215	10A	250V AC	5
5215100	10A	250V AC	25
5217	15A	--	5
5217100	15A	--	25
5218	20A	--	5
5218100	20A	--	25
5219	25A	--	5
5219100	25A	--	25
5220	30A	--	5
5220100	30A	--	25
5288	1A, 3A, 5A, 10A, 15A		5
5289	4 each 1A, 2A, 3A, 5A, 7.5A, 10A, 15A, 20A, 25A, 30A		40

MDL Fuses

Part #	Amps	Volts	Retail Pack
5226	3A	250V AC	2
5227	5A	250V AC	2
5228	6.25A	250V AC	2
5229	7.5A	250V AC	2
5230	10A	--	2
5231	15A	--	2
5232	20A	--	2
5233	25A	--	2
5234	30A	--	2



5289
Includes a Heavy Duty In-Line Fuse Holder 5063 p. 62

Related Products

AGC or MDL In-Line fuse holders page 62



ST-Glass Fuse Blocks page 63

Protect your boat with the correct size wire and fuse, see p. 161

ATM® Fuses

Mini blade-type fuse

- Color-coded for easy identification
- Visible indication of blown condition
- Tin-plated connector blades for corrosion resistance



Interrupting Capacity	1,000A
Voltage Max. Operating	32V DC
Blow Time Delay	See blueseas.com

Part #	Amps	Retail Pack
5261	2A	2
5262	3A	2
5263	4A	2
5270	5A	2
5264	7.5A	2
5271	10A	2
5272	15A	2
5273	20A	2
5265	25A	2
5274	30A	2
5286	5A, 10A, 15A, 20A, 30A	5

Protect your boat with the correct size wire and fuse, see p. 161

ATO® or ATC® Fuses

Fast-acting blade fuse

- Color-coded for easy identification
- Visible indication of blown condition
- Tin-plated connector blades for corrosion resistance



Interrupting Capacity	1,000A
Voltage Max. Operating	32V DC
Blow Time Delay	See blueseas.com

Part #	Amps	Retail Pack	Part #	Amps	Retail Pack
5235	1A	2	5235100	1A	25
5236	2A	2	5236100	2A	25
5237	3A	2	5237100	3A	25
5238	4A	2	5239100	5A	25
5239	5A	2	5240100	7.5A	25
5240	7.5A	2	5241100	10A	25
5241	10A	2	5242100	15A	25
5242	15A	2	5243100	20A	25
5243	20A	2	5244100	25A	25
5244	25A	2	5245100	30A	25
5245	30A	2			
5246	40A	2			
5287	5A, 10A, 15A, 20A, 25A, 30A	6			

Protect your boat with the correct size wire and fuse, see p. 161

Related Products



Fuse Holders page 62



ST-Blade Fuse Blocks page 64



SafetyHub Fuse Blocks page 73



WeatherDeck Waterproof Fuse Panels page 117

NEW



ST-Blade Water-Resistant Fuse Block page 64

easyID™ ATC® Fuses

Fast-acting easyID™ illuminated blade fuses use Light Emitting Diode (LED) technology to show when a fuse has blown.

- Color-coded for easy identification
- Visible indication of blown condition
- Tin-plated connector blades for corrosion resistance



Interrupting Capacity	1,000A
Voltage Max. Operating	32V DC
Blow Time Delay	See blueseas.com

Part #	Amps	Retail Pack
5291	3A	2
5292	5A	2
5293	7.5A	2
5294	10A	2
5295	15A	2
5296	20A	2
5297	25A	2
5298	30A	2
5299	40A	2
5290	3x 3A, 3x 5A, 3x 7.5A, 3x 10A, 6x 15A, 3x 20A, 3x 25A, 3x 30A, 3x 40A	30

Protect your boat with the correct size wire and fuse, see p. 161



5290

MAXI® Fuses

Provides economical branch circuit protection

- Color-coded for easy identification
- Silver-plated connector blades for corrosion resistance
- Visible indication of blown condition



Interrupting Capacity	1,000A
Voltage Max. Operating	32V DC
Blow Time Delay	See blueseas.com

Part #	Amps	Retail Pack
5138	30A	1
5139	40A	1
5140	50A	1
5141	60A	1
5142	70A	1
5143	80A	1

Protect your boat with the correct size wire and fuse, see p. 161

Related Products



MAXI In-Line Fuse Holder p. 62



MAXI Fuse Block p. 63

AMI® or MIDI® Fuses

Compact fuse for main or branch
30A to 200A circuit protection

- Color-coded for easy identification
- Visible indication of blown condition
- Tin-plated connector blades for corrosion resistance



Interrupting Capacity	5,000A @ 16V DC 2,000A @ 32V DC
Voltage Max. Operating	32V DC

Regulatory

Meets SAE J1171 external ignition protection requirements when used with Blue Sea Systems' Fuse Blocks IP66 – protected against powerful water jets (see inside back cover)

IGNITION PROTECTED

Part #	Amps	Color	Retail Pack
5250	30A	Orange	2
5251	40A	Green	2
5252	50A	Red	2
5253	60A	Yellow	2
5254	70A	Brown	2
5255	80A	White	2
5256	100A	Blue	2
5257	125A	Pink	2
5258	150A	Lt Blue	2
5259	175A	Tan	2
5260	200A	Purple	2

Related Products



Safety Fuse Block 7720
p. 72



SafetyHub Fuse Blocks
p. 73

MEGA® or AMG® Fuses

Economical fuse for 100A to
300A circuit protection

Interrupting Capacity	1,000A
Voltage Max. Operating	32V DC
Trip Time Delay	See bluesease.com



Regulatory

Meets SAE J1171 external ignition protection requirements When used with Blue Sea Systems' Safety Fuse Block 7721 (p. 72) IP66 – protected against powerful water jets (see inside back cover)

IGNITION PROTECTED

Part #	Amps	Retail Pack
5101	100A	1
5102	125A	1
5103	150A	1
5104	175A	1
5105	200A	1
5107	250A	1
5108	300A	1

Protect your boat with the correct size wire and fuse, see p. 161

Related Products



MEGA or AMG
Fuse Block
page 70



Safety Fuse Block 7721
page 72

MRBF Fuses

MRBF—Marine Rated Battery Fuse

Space-saving ignition protected fuse for
30 to 300 Amp loads. Must use with
MRBF Fuse Blocks (p. 70)

- Color-coded for easy identification
- Visible indication of blown condition



Interrupting Capacity	10,000A @ 14V DC 5,000A @ 32V DC 2,000A @ 58V DC
-----------------------	--

Voltage Max. Operating 58V DC

Fuse Hole Opening M8 (5/16")

Trip Time Delay See bluesease.com

Regulatory

Meets SAE J1171 external ignition protection requirements IP66 – protected against powerful water jets (see inside back cover)

IGNITION PROTECTED

ABYC E-11.10.1.1.1. Overcurrent Protection Device Location - Ungrounded conductors shall be provided with overcurrent protection within a distance of seven inches (175mm) of the point at which the conductor is connected to the source of power measured along the conductor

Part #	Amps	Color	Retail Pack
5175	30A	LT Green	1
5176	40A	LT Blue	1
5177	50A	Red	1
5178	60A	Gold	1
5180	75A	Brown	1
5181	80A	Lime	1
5182	90A	Purple	1
5183	100A	Yellow	1
5184	125A	Green	1
5185	150A	Orange	1
5186	175A	White	1
5187	200A	Blue	1
5189	250A	Pink	1
5190	300A	Gray	1

Protect your boat with the correct size wire and fuse, see p. 161

Related Products



MRBF Fuse Blocks
page 70

Class-T Fuses

High interrupt capacity for large battery banks including Lithium-Ion and TPPL batteries



- Extremely fast short-circuit response
- Recommended by most inverter manufacturers

Interrupting Capacity	20,000A @ 125V DC
Voltage Max. Operating	125V DC
Trip Time Delay	See bluesease.com
Regulatory	UL listed to standard 248-15

Part #	Amps	Retail Pack
5112	110A	1
5113	125A	1
5114	150A	1
5115	175A	1
5116	200A	1
5117	225A	1
5118	250A	1
5119	300A	1
5120	350A	1
5121	400A	1

Protect your boat with the correct size wire and fuse, see p. 161

Related Products

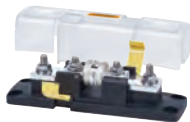

Class-T Fuse Blocks page 71

ANL Fuses

For 35A to 750A circuit protection



- Silver-plated connector blades for corrosion resistance
- Visible indication of blown condition

Interrupting Capacity	6,000A @ 32V DC
Voltage Max. Operating	32V DC
Trip Time Delay	See bluesease.com
Regulatory	35-500A ONLY - Meets SAE J1171 external ignition protection requirements

IGNITION PROTECTED

Part #	Amps	Retail Pack
5164	35A	1
5165	40A	1
5122	50A	1
5123	60A	1
5124	80A	1
5125	100A	1
5126	130A	1
5127	150A	1
5128	175A	1

Part #	Amps	Retail Pack
5129	200A	1
5131	250A	1
5133	300A	1
5135	350A	1
5136	400A	1
5137	500A	1
Not Ignition Protected		
5161	600A	1
5163	750A	1

Protect your boat with the correct size wire and fuse, see p. 161

Related Products



ANL Fuse Blocks page 71



AGC® or MDL® In-Line Fuse Holders

Crimpable In-Line Fuse Holder

- Accepts 12-16 AWG wire
- 30A Max. fuse amperage
- Fuse sold separately (p. 58)



Part #	Description
5060	AGC or MDL In-Line Fuse Holder

Waterproof In-Line Fuse Holder

- Accepts 12-18 AWG wire
- 30A Max. fuse amperage
- Fuse sold separately (p. 58)



Part #	Description
5061	Waterproof In-Line Fuse Holder

Waterproof In-Line Fuse Holder

- Accepts 12-16 AWG wire
- 20A Max. fuse amperage
- Fuse sold separately (p. 58)



Part #	Description
5062	Waterproof In-Line Fuse Holder

Heavy Duty In-Line Fuse Holder

- Accepts 12-18 AWG wire
- 30A Max. fuse amperage
- Fuse sold separately (p. 58)



Part #	Description
5063	Heavy Duty In-Line Fuse Holder

Water-Resistant Fuse Holder Panel Mount

- Rated IP66 on front – protected against powerful water jets
- 20A Max. fuse amperage
- 0.50" (12.70 mm) mounting hole
- Fuse sold separately (p. 58)



5022 Replacement cap for 5021

Part #	Description
5021	Water Resistant Panel Mount Fuse Holder
5022	Replacement Cap

Related Products



AGC Fuses
page 58

MDL Fuses
page 58

ATO® or ATC® In-Line Fuse Holders

In-Line Fuse Holder

- Supplied with 12 AWG pigtails
- 30A Max. fuse amperage
- Fuse sold separately (p. 59)



5064

Waterproof In-Line Fuse Holder

- Supplied with 12 AWG pigtails
- 30A Max. fuse amperage
- Fuse sold separately (p. 59)



5065

Part #	Description
5064	ATO or ATC In-Line Fuse Holder
5065	ATO or ATC Waterproof In-Line Fuse Holder

Related Products

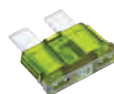

ATO or ATC Fuses
p. 59



easyID ATC Fuses
p. 59

MAXI® In-Line Fuse Holder

In-line fuse holder for MAXI Fuses



- Supplied with 5 inch #6 lead wires and two adhesive lined sealing shrink wrap tubes for sealed terminations
- Firewall mounting hole permits two or more holders to be mounted together
- Protective cover with retaining strap
- Fuse sold separately (p. 59)

Voltage Max. Operating	32V DC
Amperage Max. Continuous	8A
Fuse Max. Amperage	60A
Mounting Hole	1/4", M6, or #12 Screws

Part #	Description
5068	MAXI In-Line Fuse Holder

Related Products



MAXI Fuses
page 59

MAXI® Fuse Block

Ignition protected fuse block allows for installation in a gasoline engine compartment



NOTE: 5006100 replaces 5006

- Snap-on terminal cover insulates all conductive parts, satisfying ABYC/USCG requirements
- Cover breakouts allow wires from sides or bottom
- Terminal screws compress fuse blades within blocks for low resistance connections
- Label recess accepts large format label (p. 156)
- Fuses sold separately (p. 59)

Voltage Max. Operating	32V DC
Amperage Max. Operating	80A
Wire Size	14–4 AWG
MAXI® Fuses available	30A–80A
Screw Terminal Torque	25 in-lb
Mounting	#10 Screws

Regulatory
 CE marked
 Meets ISO 8846 and SAE J1171 external ignition protection requirements when cover is securely latched and all mounting screws are installed.

IGNITION PROTECTED

Part #	Description
5006100	MAXI Fuse Block

For the full list of specifications see page 75

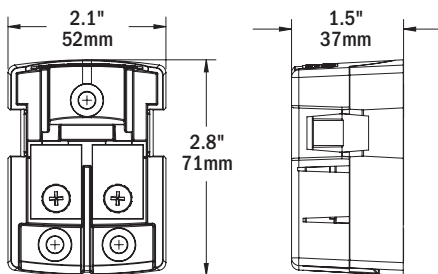

Related Products



MAXI Fuses
page 59

ST-Glass Fuse Blocks

Innovative design allows for labeling, spare fuse storage, and easy fuse removal



5015

- Can be used for 24-hour circuits
- Screw terminals for securing wires
- Integrated fuse ejector levers
- Clear insulating cover satisfies ABYC/USCG insulation requirements, accepts Large Format Labels (p. 156), and provides storage for spare fuses
- Tin-plated phosphor bronze fuse clips are encapsulated and cannot be sprung
- One-piece stainless flange nuts ensure safe and secure connections
- Fuses sold separately (p. 58)

Voltage Max. Operating	32V DC
Amperage Max. Operating	30A per circuit
Amperage Max. Operating	100A per block
Fuse Type	AGC or MDL Fuses
Screw Terminal	#8-32 with captive star lock washer
Mounting	#8 Screw (M4)

Part #	Circuits	Tin-plated copper negative bus
5015	6	#10-32 stud
5018	6	--

For the full list of specifications see page 75

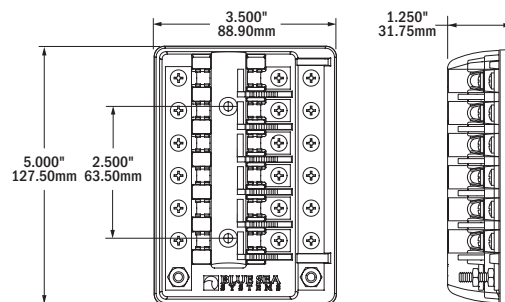

Related Products



AGC Fuses
page 58

MDL Fuses
page 58

ST-Blade Water-Resistant Fuse Block NEW

Provides water-resistant circuit protection for ATO/ATC fuses & circuit breakers in a compact footprint.

- Water-resistant IP66 design
- Accepts standard ring or fork type terminals to allow for simple wiring with standard tools
- Accepts a wide range of wire sizes
- Integral plugs maintain water-resistant rating if less than four loads are required
- Accepts ATO and ATC fast-acting blade fuses (p. 59)
- Accepts ATO/ATC-Style Low Profile Circuit Breakers (p. 79)
- Nests with ST-Blade Water-Resistant Fuse Block (5056 or 5056100) and Water-Resistant 100A Bus Bar (2356 or 2356100)
- Tin-plated copper busses and fuse clips
- Includes four write-on circuit labels
- Small format standard and custom labels available
- Spare fuse and fastener storage in cover
- Fuses (p. 59) and circuit breakers (p. 79) sold separately

Voltage Max. Operating	32V DC
Amperage Max. Operating	80A per block / 25A per circuit
Fuse Type	ATO or ATC fuses & circuit breakers
Input Wire Size	(1) 8 AWG to 4 AWG
Load Wire Size	(4) 16 AWG to 10 AWG
Bus Material	Tin-Plated Copper C11000
Mounting Thru-hole	Accepts 1/4" (6mm) screws
Screw Terminal	4x #8-32 Screws with captive star lock washer
Stud Terminal	1x #10-32

Regulatory For an ABYC/USCG compliant design use (5056100) CE marked, IP66 - protected against powerful water jets (see inside back cover)



5056100



5056

Part #	Description	Cover
5056	ST-Blade Water-Resistant Fuse Block	Screw Cover
5056100	ST-Blade Water-Resistant Fuse Block	Manual Cover

For the full list of specifications see page 75
For the mounting diagram see page 102

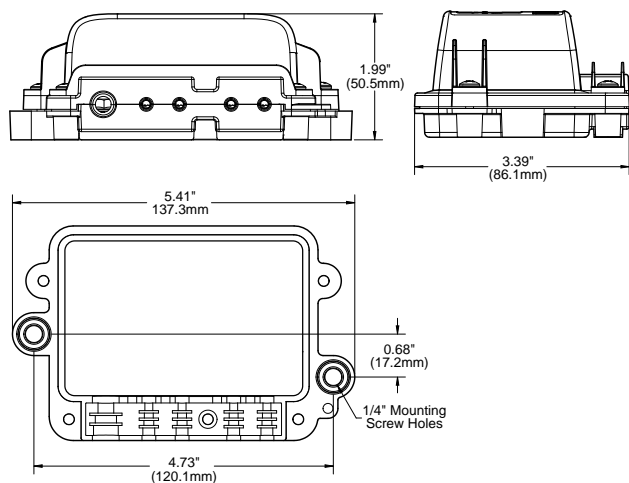

Related Products

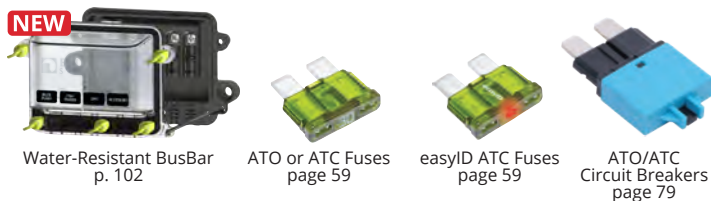

TECH tip™

ST-Blade Water-Resistant Fuse Block

The difference between our new ST-Blade Water-Resistant Fuse Blocks and Busbars are how the fuses and terminations are accessed. Part numbers 5056 / 2356 utilize #8 screws to secure the cover to the rest of the housing, requiring a screwdriver – or tool – for access; and do not meet ABYC requirements for panel boards. Part numbers 5056100 / 2356100 utilize yellow wing-screws that can be manipulated by hand, and comply to the following:

ABYC E-11.4.23 states:

Panelboard - an assembly of devices for the purpose of controlling and/or distributing power on a boat. It may include devices such as circuit breakers, fuses, switches, instruments, and indicators.

ABYC E-11.4.27 states:

Readily Accessible - capable of being reached quickly and safely for effective use under emergency conditions without the use of tools.

ABYC E-11.9.1.2 states:

A panelboard shall be installed in a readily accessible location and shall be weatherproof or be protected from weather and water splash.

The ST-Blade Water-Resistant Fuse Blocks and Busbars are rated IP66 and withstand water from heavy seas or projected in powerful jets, allowing for flexible installations anywhere on boats or vehicles.

ST-Blade Battery Terminal Mount Fuse Block



Easily add 4 fused circuits to the terminal of a battery. Provides power to new accessories in your boat or vehicle.

- Mounts on the battery terminal stud
- Screw terminals for securing wires
- Nylon insulated ring terminals included for each screw terminal
- Insulating cover meets ABYC/USCG insulation requirements
- Ignition protected - for use in a gasoline engine compartment
- Includes four 16-14 AWG and four 12-10 AWG Nylon insulated ring terminals
- Includes four write-on circuit labels
- Small format standard and custom labels available
- Fuses sold separately (p. 59)

Voltage Max. Operating	32V DC
Amperage Max. Operating	100A per block / 30A per circuit
Fuse Type	ATO or ATC Fuses
Bus Material	Tin-Plated Copper C11000
Mounting Thru-hole	Clearance for 3/8" [M10] stud
Screw Terminal	#8-32 Screws with captive star lock washer

Regulatory
Meets ISO 8846 and SAE J1171 external ignition protection requirements

IGNITION PROTECTED

Part #	Description
5023	ST-Blade Battery Terminal Mount Fuse Block
5024	ST-Blade Battery Terminal Mount Fuse Block Kit

For the full list of specifications see page 75

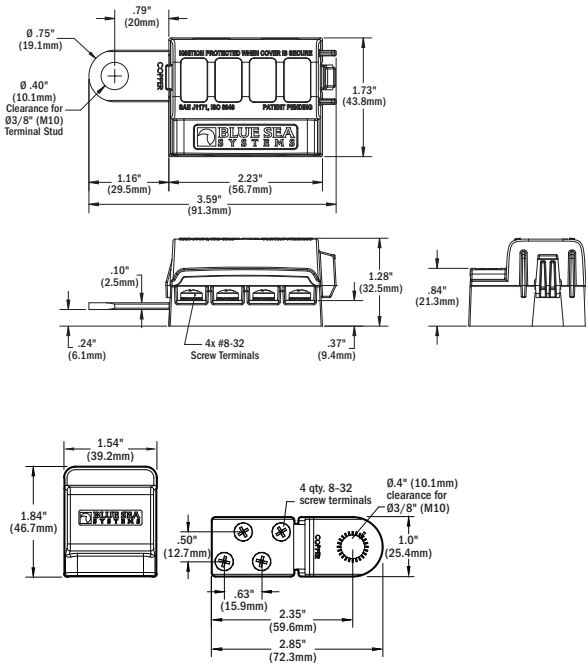

Related Products



5023



Nylon insulated ring terminals



5024

- Includes a 4-circuit negative busbar see page 107

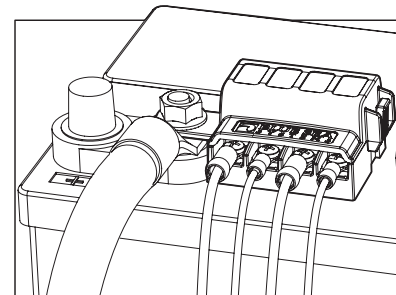

5023 Installed

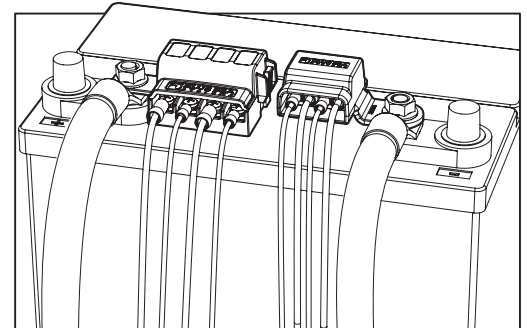

5024 Installed

ST-Blade Fuse Blocks

Independent Source

Consolidates branch circuits and eliminates in-line fuses

- Independent source fuse block
- Can be used for 24-hour circuits and switched circuit in same block
- Screw terminals for securing wires accept ring terminals
- Clear insulating cover with label recesses and storage for one fuse, satisfies ABYC/USCG insulation requirements
- Easy to open, push button latch for easy access to fuses
- Tin-plated copper buses and fuse clips
- Fuse Block with cover includes 20 write-on circuit labels and two Terminal Block Jumpers Part # 9217 (p. 105)
- Small format standard and custom labels available
- Fuses sold separately (p. 59)

Voltage Max. Operating	32V DC
Amperage Max. Operating	30A per circuit
Amperage Max. Operating	40A per jumped circuit group
Fuse Type	ATO or ATC Fuses
Screw Terminal	#8-32 Screws with captive star lock washer
Mounting	#8 Screw (M4)

Part #	Circuits	Cover
5035	6	Yes
5037	6	-

For the full list of specifications see page 75

Application Diagram

Two 24-Hour Circuits and Four Switched Circuits

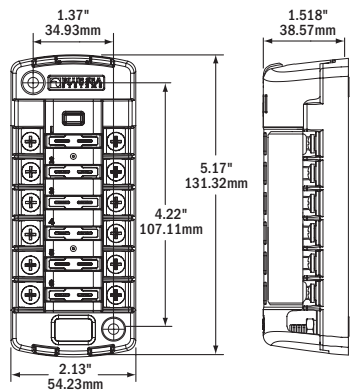
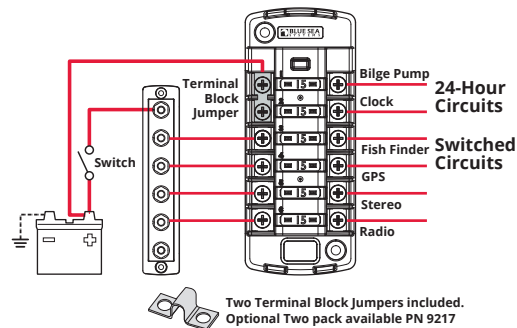

Related Products

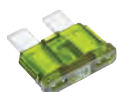

ATO or ATC Fuses
page 59



easyID ATC Fuses
page 59



Terminal Block Jumpers
page 105



5035



5037

TECH tip

Fuse Sizing Best Practices - 80% Rule

It is a common misconception that a fuse should be rated for the same amperage as the circuit. Fuses include a metal component designed to heat up when current runs through them. The more current the hotter the metal gets. When too much current runs through the fuse, the metal heats up enough to separate, breaking the circuit. This means that rating a fuse at the same amperage as the circuit will produce the maximum heat in the fuse without actually breaking the circuit. For this reason the National Electrical Code recommends limiting the amount of current in a circuit to 80% of the fuse rating in that circuit. In other words a 40A fuse would be appropriate for a circuit with a maximum of 32A continuous. This is why you will see many fuse blocks with maximum continuous amperage ratings around 80% of the largest available fuse.

ST-Blade Split Bus Fuse Block

Common and/or Independent Source

Two isolated 6-circuit fuse blocks with a negative bus. For use when a mix of switched and 24-hour circuits are desired in the same block

- Common and/or independent source fuse block
- Provides two isolated groups of six ATO/ATC circuits
- For use with either two isolated batteries or with a single battery providing a mix of 24-hour and switched circuits
- Clear insulating cover satisfies ABYC/USCG insulation requirements and provides storage for two spare fuses
- Accepts ring terminals
- Easy to open, push button latch provides easy access to fuses
- Tin-plated copper buses and fuse clips
- Includes 20 write-on circuit labels
- Fuses sold separately (p. 59)

Voltage Max. Operating	32V DC
Amperage Max. Operating	30A per circuit 100A total (not to exceed 80A per load group)
Fuse Type	ATO or ATC Fuses
Screw Terminal	#8-32 Screws with captive star lock washer
Mounting	#8 Screw (M4)
Recommended Wire Size	Positive Feed: 4-6 AWG (25-16 mm ²) Branch Circuits: 10-16 AWG (6-15 mm ²)
Recommended Torque	#10 Stud: 24 in-lb (2.71 N-m) #8 Screw: 18 in-lb (2.03 N-m)



Part #	Circuits	Cover	Negative Bus	Positive Bus
5032	12	Yes	#10-32 stud	#10-32 stud



For the full list of specifications see page 75

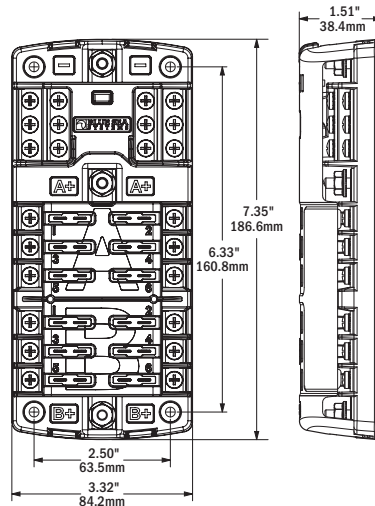
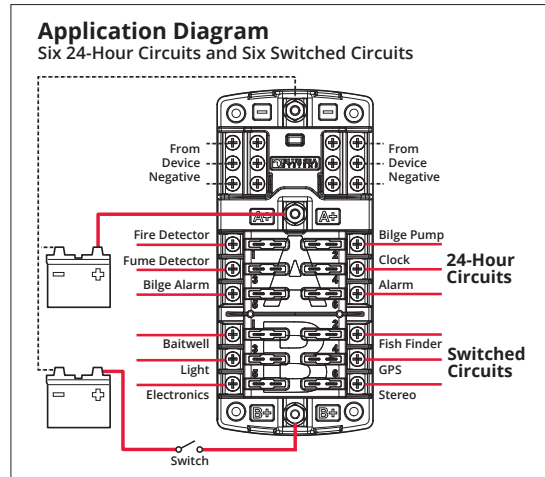
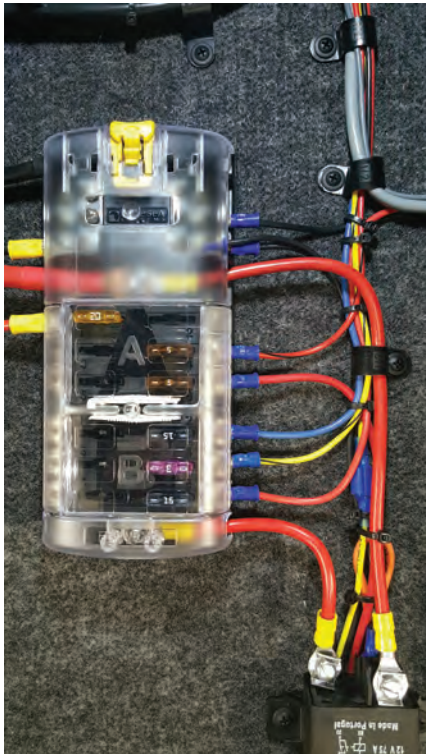

Related Products

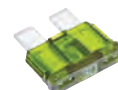

ATO or ATC Fuses
page 59



easyID ATC Fuses
page 59

ST-Blade Common Source Fuse Blocks

Common Source

Consolidates branch circuits and in-line fuses

- Common source fuse block
- Screw terminals for securing wires accept ring terminals
- One-piece stainless flange nuts ensure safe and secure connections
- Clear insulating cover with label recesses and storage for two fuses, satisfies ABYC/USCG insulation requirements
- Easy to open, push button latch for easy access to fuses
- Tin-plated copper buses and fuse clips
- Fuse blocks with covers include 20 write-on circuit labels small format standard and custom labels available
- Fuses sold separately (p. 59)

Voltage Max. Operating	32V DC
Amperage Max. Operating	30A per circuit 100A per block
Fuse Type	ATO or ATC Fuses
Screw Terminal	#8-32 Screws with captive star lock washer
Mounting	#8 Screw (M4)

Part #	Circuits	Cover	Negative Bus	Positive Bus	[A] Width in (mm)	[B] Mounting Centers in (mm)	[C] Height in (mm)	[D] Mounting Centers in (mm)
5025	6	Yes	#10-32 stud	#10-32 stud	3.32 (84.20)	2.50 (63.50)	4.89 (124.31)	3.88 (95.58)
5028	6	Yes	--	#10-32 stud	3.32 (84.20)	2.50 (63.50)	3.65 (92.76)	2.64 (67.03)
5030	6	--	#10-32 stud	#10-32 stud	3.32 (84.20)	2.50 (63.50)	4.89 (124.31)	3.88 (95.58)
5033	6	--	--	#10-32 stud	3.32 (84.20)	2.50 (63.50)	3.65 (92.76)	2.64 (67.03)
5026	12	Yes	#10-32 stud	#10-32 stud	3.32 (84.20)	2.50 (63.50)	6.47 (164.39)	5.46 (138.66)
5029	12	Yes	--	#10-32 stud	3.32 (84.20)	2.50 (63.50)	5.23 (132.84)	4.22 (107.11)
5031	12	--	#10-32 stud	#10-32 stud	3.32 (84.20)	2.50 (63.50)	6.47 (164.39)	5.46 (138.66)
5034	12	--	--	#10-32 stud	3.32 (84.20)	2.50 (63.50)	5.23 (132.84)	4.22 (107.11)

For the full list of specifications see page 75

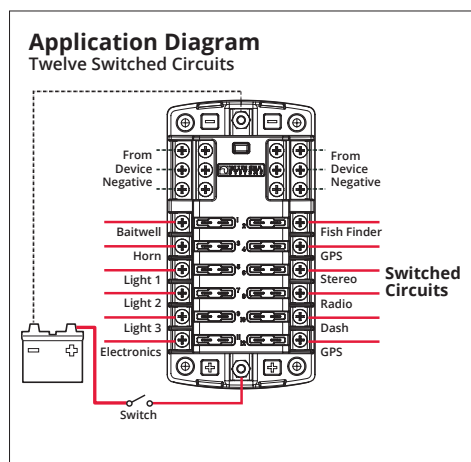
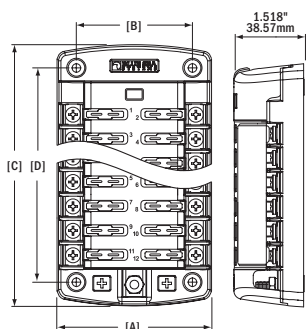

5028 with cover
5033 without cover



5025 with cover
5030 without cover



5029 with cover
5034 without cover



5026 with cover
5031 without cover

Related Products



ATO or ATC Fuses
page 59

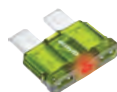

easyID ATC Fuses
page 59



WeatherDeck Switch Only
page 117

ST-Blade Compact Fuse Blocks

Common Source

Provides surface mount circuit protection for ATO or ATC Fuses in a compact footprint. The single side design allows wire entry from one side to maximize space.

- Compact common source fuse block
- Accepts ATO and ATC fast acting blade fuses
- Single side entry wiring
- Ignition Protected - for use in a gasoline engine compartment
- Insulating cover meets ABYC/USCG insulation requirements
- Tin-plated copper buses and fuse clips
- Accepts ring or snap fork type terminals
- Includes write-on circuit labels for each circuit
- Small format standard and custom labels available
- Fuses sold separately (p. 59)

Voltage Max. Operating	32V DC
Amperage Max. Operating	30A per circuit 100A per block
Fuse Type	ATO or ATC Fuses
Screw Terminal	#8-32 Screws with captive star lock washer
Mounting	#8 Screw (M4)
Regulatory Meets ISO 8846 and SAE J1171 external ignition protection requirements	

Part #	Circuits	Cover
5045	4	Yes
5046	8	Yes



For the full list of specifications see page 75



5045



5046

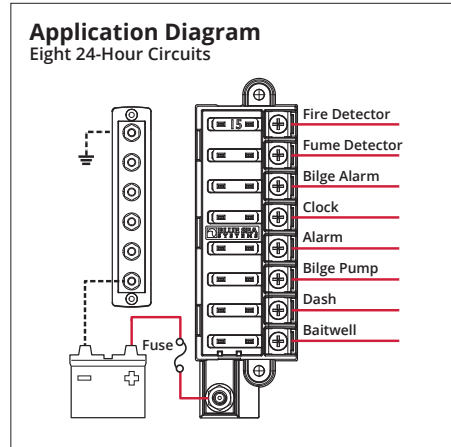
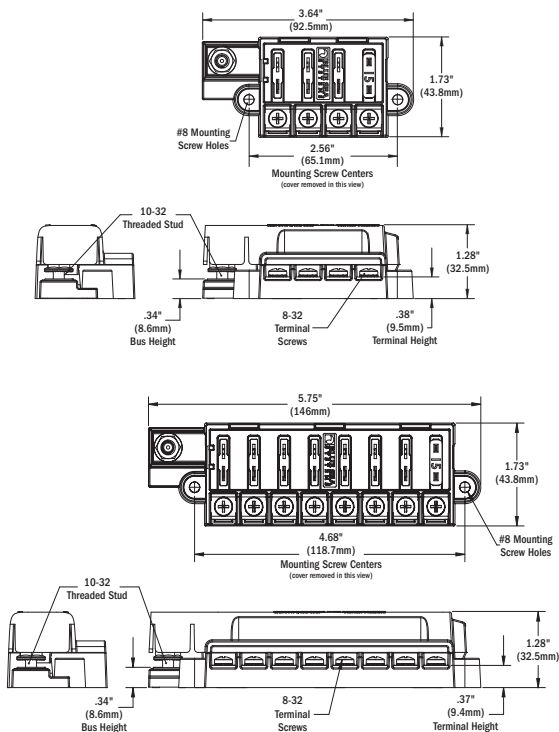

Related Products



ATO or ATC Fuses
page 63



easyID ATC Fuses
page 63

MRBF Surface Mount Fuse Blocks

MRBF—Marine Rated Battery Fuse

- Surface mount fuse blocks accommodate three MRBF fuses for consolidated high amperage circuit protection
- The independent source fuse block (5194) is ideal for 3 output battery chargers
- The common source fuse block (5196) provides 3 loads from a single source
- Clip-on cover insulates terminal connections
- Versatile wiring options allow all wires to come out a single side
- Label recesses for easy circuit identification
- One-piece stainless flange nuts ensure safe and secure connections
- Ignition protected when used with MRBF fuses
- Fuses sold separately (p. 60)

	5194	5196
Voltage Max. Operating	58V DC	58V DC
Amps Max. Operating (using 4/0 cables)	300 per block	300 per block
	--	240A per circuit
Terminal Fuses Available	30A–300A	30A–300A
Terminal Stud Size	5/16" -18 (8mm)	5/16" -18 (8mm)
Mounting Hole Size	#10 (5mm)	#10 (5mm)

Regulatory

Meets ISO 8846 and SAE J1171 external ignition protection requirements when used with MRBF fuses and cover is securely latched

IGNITION PROTECTED

Part #	Description	Fuses
5194	Independent Source	3
5196	Common Source	3

For the full list of specifications see page 75

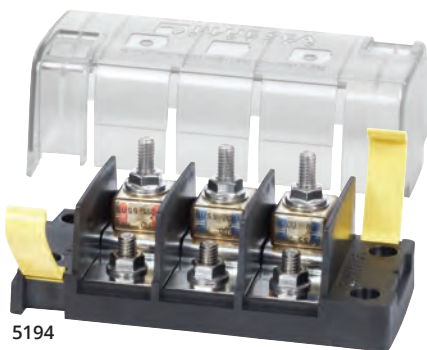

5194

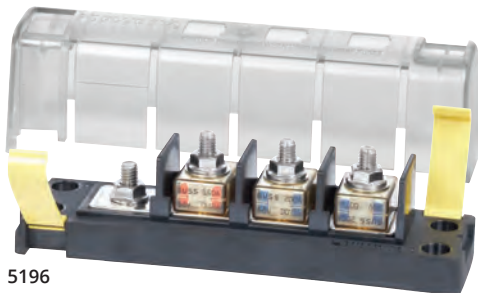

5196

Related Products



MRBF Fuses
page 60

MRBF Terminal Fuse Blocks

MRBF—Marine Rated Battery Fuse

Satisfies ABYC 7" circuit protection rule by mounting on a 3/8" battery post, battery switch, or bus bar

- Appropriate for DC Main, inverter, windlass, and bow thruster circuit protection
- Weatherproof – suitable for small open-cockpit boats and other harsh environments
- Insulating cap prevents accidental shorts
- Ignition protected when used with MRBF fuses
- Fuses sold separately (p. 60)

Voltage Max. Operating	58V DC
Amperage Max. Operating	300A
Terminal Fuses Available	30–300 Amps
Regulatory	
Meets SAE J1171 external ignition protection requirements	

IGNITION PROTECTED

Part #	Terminal Stud Size	Mounting	Fuses
5191	M8 (5/16"-18)	3/8"	1
2151	M8 (5/16"-18)	3/8"	2

For the full list of specifications see page 75

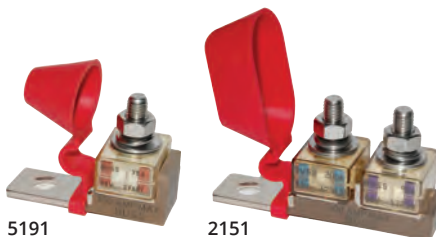

5191

2151

Related Products



MRBF Fuses
page 60

MEGA® or AMG® Fuse Block

Provides an economical system for 100 to 300 Amp fusing

- Insulating cover with breakouts satisfies ABYC/USCG insulation requirements
- Stainless steel studs provide resistance to corrosion and allow high torque
- UL 94-V0 base resists high heat
- Fuses sold separately (p. 64)

Voltage Max. Operating	32V DC
Amperage Max. Operating	300A
Wire Size to Meet Rating	4/0 AWG (120mm ²)
Fuses available	100–300 Amps



Part #	Terminal Stud Size	Mounting
5001	5/16"-18 (M8)	#10 (M5) Screws

For the full list of specifications see page 75

Related Products



MEGA or AMG Fuses
page 60

Class-T Fuse Blocks

Allows the use of Class T fuses for fast acting circuit protection of inverters and other electronics



5502

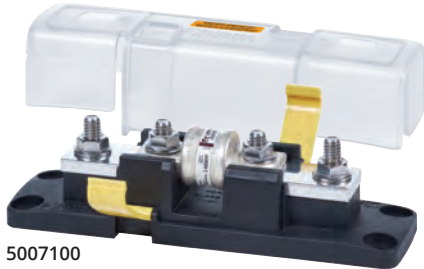

5007100

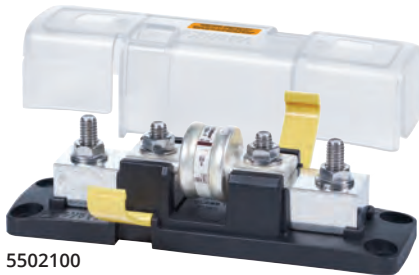

5502100

- Four stud design provides ample access around connecting stud to install large cable lugs without obstruction from the fuse
- Insulating cover satisfies ABYC/USCG insulation requirements
- Cover breakouts allow wire access in any direction
- Stud design ensures secure fuse mounting even with high heat
- Stainless steel studs provide resistance to corrosion and high torque
- One-piece stainless flange nuts ensure safe and secure connections
- UL 94-V0 base resists high heat
- Fuse sold separately (p. 61)

Voltage Max. Operating	160V DC
Mounting	1/4" (M6) Screws
Fuse Mounting Blocks	Tin-Plated Copper
Regulatory	5007100 & 5502100 Meets ISO 8846 and SAE J1171 external ignition protection requirements when cover is secure

IGNITION PROTECTED

Part #	Class T Fuses	Terminal Stud Size	Amps Max. Operating
5502	225A-400A	3/8"-16 (M10)	320A
5007100	110A-200A	1/4"-20 (M6)	160A
5502100	225A-400A	5/16"-18 (M8)	320A

For the full list of specifications see page 75

Related Products



Class-T Fuses
page 661

ANL® Fuse Blocks

Accepts a wide range of ANL fuse amperages for versatile fusing



5005



5503

- Swing out design allows replacement of the fuse without removing fasteners
- Insulating cover satisfies ABYC/USCG insulation requirements
- Cover breakouts allow wire access in any direction
- Insert molded studs ensure secure fuse mounting
- Stainless steel studs provide resistance to corrosion and high torque
- One-piece stainless flange nuts ensure safe and secure connections
- UL 94-V0 base resists high heat
- Fuse sold separately (p. 61)

	5503	5005
Voltage Max. Operating	32V DC	32V DC
Terminal Stud Size	5/16"-18 (M8)	5/16"-18 (M8)
Cable Size	Up to 4/0 AWG	Up to 2/0 AWG
Fuse Mounting Blocks	Tin-Plated Copper	Tin-Plated Copper
ANL Fuses Available	35-750 Amps	35-300 Amps

Part #	Terminal Stud Size	Amps Max. Operating	Mounting
5005	5/16"-18 (M8)	300A	#10 (M5) Screws
5503	5/16"-18 (M8)	750A	1/4" (M6) Screws

For the full list of specifications see page 75

Related Products



ANL Fuses
page 61

TECH tip™

ABYC guidelines and Ignition Protection

Blue Sea Systems fuse blocks marked ignition protected

are designed and tested for ignition protection, enabling them to be installed in a compartment where gasoline or other explosive fumes may be present.

Blue Sea Systems' fuse blocks that meet the U.S. Coast Guard ignition protection requirements include the MAXI®, ST-Blade Battery Terminal Mount, ST-Blade Compact, Terminal MRBF, Class-T, Safety, and SafetyHub Fuse Blocks.

The U.S. Coast Guard states:

An electrical component that is "ignition protected" is capable of operating in an explosive environment without igniting that environment. "Ignition protection" of electrical devices is accomplished by the use of seals, flame arrestors and potting (sealing), or a combination of such means.

Safety Fuse Block AMI® or MIDI®

Ignition protected for use on gasoline powered boats with 30A to 200A circuits



- Sealed cover protects fuses from the harsh marine environment and satisfies ABYC/USCG insulation requirements
- Cover breakouts allow wire access in three directions
- Cover accommodates a spare fuse
- One-piece stainless flange nuts ensure safe and secure connections
- Accepts square format standard or custom label
- Fuses sold separately (p. 60)

Voltage Max. Operating	32V DC
Wire Size to Meet Rating	2/0 AWG (70 mm ²)
Mounting holes	Accept 1/4" (M6) Screws
Terminal Stud Size	M8
Terminal Screw Size	M5 Stainless Steel

Regulatory

CE marked
Meets ISO 8846 and SAE J1171 external ignition protection requirements when cover is secure
IP66 – protected against powerful water jets (see inside back cover)

Part #	Fuse Type	Fuse Amperages Available	IGNITION PROTECTED
7720	AMI or MIDI	30–200A	

For the full list of specifications see page 75

Related Products



AMI or MIDI Fuses
page 60



ABYC guidelines and Ignition Protection

Blue Sea Systems fuse blocks marked ignition protected

are designed and tested for ignition protection, enabling them to be installed in a compartment where gasoline or other explosive fumes may be present.

Blue Sea Systems' fuse blocks that meet the U.S. Coast Guard ignition protection requirements include the MAXI®, ST-Blade Battery Terminal Mount, ST-Blade Compact, Terminal MRBF, Class-T, Safety, and SafetyHub Fuse Blocks.

The U.S. Coast Guard states:

An electrical component that is "ignition protected" is capable of operating in an explosive environment without igniting that environment. "Ignition protection" of electrical devices is accomplished by the use of seals, flame arrestors and potting (sealing), or a combination of such means.

Safety Fuse Block MEGA® or AMG®

Ignition protected for use on gasoline powered boats with 30A to 300A circuits

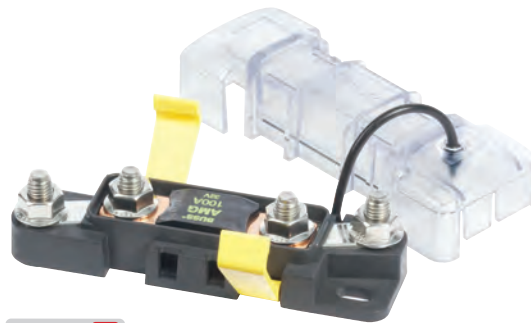

- Sealed cover protects fuses from the harsh marine environment and satisfies ABYC/USCG insulation requirements
- Cover breakouts allow wire access in three directions
- One-piece stainless flange nuts ensure safe and secure connections
- Accepts square format standard or custom label
- Fuses sold separately (p. 60)

Voltage Max. Operating	32V DC
Wire Size to Meet Rating	2/0 AWG (70 mm ²)
Mounting holes	Accept 1/4" (M6) Screws
Terminal Stud Size	M8

Regulatory

CE marked
Meets ISO 8846 and SAE J1171 external ignition protection requirements when cover is secure
IP66 – protected against powerful water jets (see inside back cover)

Part #	Fuse Type	Fuse Amperages Available	IGNITION PROTECTED
7721	MEGA or AMG	100–300A	

For the full list of specifications see page 75

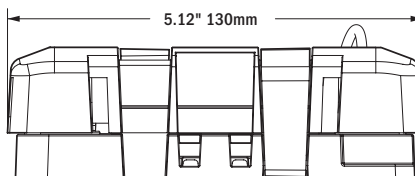
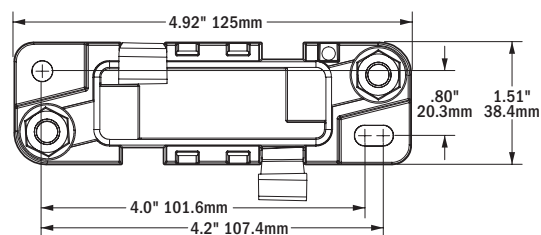

Related Products



MEGA or AMG Fuses
page 60

SafetyHub 100 Fuse Block

The SafetyHub 100 combines an ignition protected fuse block and integrated connecting plugs. It is safe for use on gasoline powered boats, reduces wiring connections, and consolidates up to seven fused circuits.



- Accepts three AMI or MIDI Fuses for high-amp circuits including panel feeds, windlasses, and stereo amplifiers
- Accepts four ATO or ATC Fuses for circuits including bilge pumps, electronics and lights
- Sealed cover protects fuses from the harsh marine environment and satisfies ABYC/USCG insulation requirements
- Integrated connector plug eliminates loose wires and provides a secure, waterproof connection
- Fuses sold separately (p. 59-60)

Amperage Max. Operating (combined)	280A
Voltage Nominal Operating	12V DC
Minimum Cable Size to Meet Ratings	4/0 AWG (120 mm ²)
Recommended Ring Terminal	M8 (5/16")
MIDI or AMI Fuse Block	
Amperage Max. Operating (per block)	240A [†]
Amperage Max. Operating (per circuit)	170A [†]
Fuse Amperages Available	30–200A
Minimum Cable Size to Meet Ratings	2/0 AWG (70 mm)
ATO or ATC Fuse Block	
Amperage Max. Operating (per block)	50A [†]
Amperage Max. Operating (per circuit)	20A [†]
Fuse Amperages Available	1A–20A
Regulatory	
CE marked	
Meets ISO 8846 and SAE J1171 external ignition protection requirements when cover is secure	
IP66 – protected against powerful water jets (see inside back cover)	

[†] Ratings are dependent on input cable sized for appropriate amperages

Part #	Description
7725	SafetyHub 100 Fuse Block



For the full list of specifications see page 75

Related Products



ATO or ATC Fuses
page 59



easyID ATC Fuses
page 59



AMI or MIDI Fuses
page 60

SafetyHub 150 Fuse Block

The SafetyHub 150 is an ignition protected fuse block with screw termination. It is safe for use on gasoline powered boats, reduces wiring connections, and consolidates up to ten fused circuits.

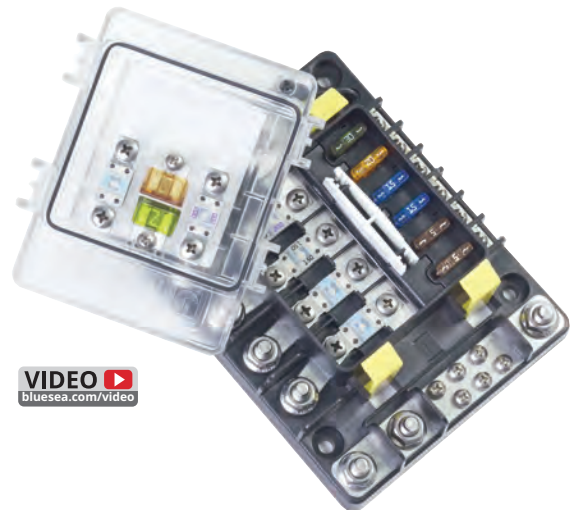

- Accepts four AMI or MIDI Fuses for high-amp circuits including panel feeds, windlasses, and stereo amplifiers
- Accepts six ATO or ATC Fuses for circuits including bilge pumps, electronics and lights
- Sealed cover protects fuses from the harsh marine environment and satisfies ABYC/USCG insulation requirements
- Negative bus provides common location for negative connection
- Circuit identification label with write-on capability
- Fuse puller to remove ATO or ATC Fuses
- Cover provides storage space for spare fuses and mounting screws
- One-piece stainless flange nuts ensure safe and secure connections
- Fuses sold separately (p. 59-60)

Amperage Max. Operating (combined)	280A
Voltage Max. Operating	32V DC
Minimum Cable Size to Meet Ratings	4/0 AWG (120 mm ²)
Recommended Ring Terminal	M8 (5/16")
Stud Size	M8
MIDI or AMI Fuse Block	
Amperage Max. Operating (per block)	280A [†]
Amperage Max. Operating (per circuit)	170A [†]
Fuse Amperages Available	30–200A
Minimum Cable Size to Meet Ratings	2/0 AWG (70 mm)
Screw Size	M5
ATO or ATC Fuse Block	
Amperage Max. Operating (per block)	50A [†]
Amperage Max. Operating (per circuit)	25A [†]
Fuse Amperages Available	1A–20A
Screw Size	#8-32
Regulatory	
CE marked	
Meets ISO 8846 and SAE J1171 external ignition protection requirements when cover is secure	
IP66 – protected against powerful water jets (see inside back cover)	







[†] Ratings are dependent on input cable sized for appropriate amperages

Part #	Description
7748	SafetyHub 150 Fuse Block





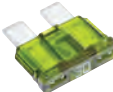
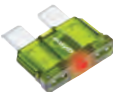

For the full list of specifications see page 75







Fuse Specification Table

Product	GMA	AGA	AGC	MDL	ATM	ATO or ATC	easyID	MAXI
	AC/DC		AC/DC	AC/DC				
								
Page Number	58	58	58	58	59	59	59	59
Interrupting Capacity DC	-	-	-	-	1,000A DC	1,000A DC	1,000A DC	1,000A DC
Maximum Voltage DC	24V DC	32V DC	32V DC	32V DC	32V DC	32V DC	32V DC	32V DC
Maximum Voltage AC	5-10A: 125V AC 1-3A: 250V AC	-	.25-10A: 250V AC	3-7.5A: 250V AC	--	--	--	--
Amperage Range	1-10A	20A	.25-30A	3-30A	2-30A	1-30A	3-40A	30-80A
Quantity Per Package	3	5	5 or 25	2	2	2 or 25	2	1









* Certain amperages of GMA®, AGC®, and MDL® fuses are AC/DC rated. See product page for specific ratings

Product	MRBF	AMI or MIDI	MEGA or AMG	Class-T	ANL
					
Page Number	60	60	60	61	61
Interrupting Capacity	10,000A @ 14V DC 5,000A @ 32V DC 2,000A @ 58V DC	5,000A @ 16V DC 2,000A @ 32V DC	2,000A @ 32V DC	20,000A @ 125V DC	6,000A @ 32V DC
Maximum Voltage	58V DC	32V DC	32V DC	125V DC	32V DC
Amperage Range	30-300A	30-200A	100-300A	110-400A	35-750A
Quantity Per Package	1	2	1	1	1
Regulatory	SAE J1171 IP66 - protected against powerful water jets.	ISO 8846 and SAE J1171 when used with Blue Sea Systems' SafetyHubs and Safety Fuse Block Part # 7720.	ISO 8846 and SAE J1171 when used with Blue Sea Systems' Safety Fuse Block Part # 7721.	--	35-500A Meets ISO 8846 and SAE J1171.



In-Line Fuse Holder Specification Table

Product	Crimpable	Waterproof	Heavy Duty	Water Resistant	ATO or ATC	Waterproof ATO or ATC	MAXI	
								
Part #	5060	5061	5062	5063	5021	5064	5065	5068
Page Number	62	62	62	62	62	62	62	62
For use with	AGC or MDL	AGC or MDL	AGC or MDL	AGC or MDL	AGC or MDL	ATO or ATC	ATO or ATC	MAXI
Wire Size	12-16 AWG	12-18 AWG	12-16 AWG	12 AWG Pigtails	-	12 AWG Pigtails	12 AWG Pigtails	#6 Red Lead Wire
Maximum Amperage	30A per circuit	30A per circuit	20A per circuit	30A per circuit	20A per circuit	30A per circuit	30A per circuit	60A per circuit
Regulatory	--	--	--	--	IP66 on front - protected against powerful water jets.	--	--	--

Fuse Block Specification Table

Product	MAXI	ST-Glass	ST-Blade					
								
Part #	5006100	5015 & 5018	5056 & 5056100	5023	5035 & 5037	5032	5028, 5025, 5029 & 5026	5045 & 5046
Page Number	63	63	64	65	66	67	68	69
For use with	MAXI	AGC or MDL	ATO or ATC	ATO or ATC	ATO or ATC	ATO or ATC	ATO or ATC	ATO or ATC
Maximum Voltage	32V DC	32V DC	32V DC	32V DC	32V DC	32V DC	32V DC	32V DC
Maximum Amperage per circuit	80A	30A	25A	30A	30A	30A	30A	30A
Maximum Amperage per block	80A	100A	80A	100A	40A per jumped circuit group	100A (not to exceed 80A per load group)	100A	100A
Available Fuses	30-80A	.25-30A	1-30A	1-30A	1-30A	1-30A	30-300A	1-30A
Ingress Protected	--	--	IP66-protected against powerful water jets.	--	--	--	--	IP66-protected against powerful water jets.
Ignition Protected	ISO 8846, SAE J1171 when cover is secure.	--	--	ISO 8846, SAE J1171 when cover is secure.	--	--	--	ISO 8846, SAE J1171 when cover is secure.

Product	MRBF Terminal	MRBF Surface	MRBF Surface	MEGA or AMG	Class-T	Class-T	Class-T
							
Part #	2151 & 5191	5194	5196	5001	5502	5007100	5502100
Page Number	70	70	70	71	71	71	71
For use with	Terminal (MRBF)	Terminal (MRBF)	Terminal (MRBF)	MEGA or AMG	Class-T	Class-T	Class T
Maximum Voltage	58V DC	58V DC		32V DC	160V DC	160V DC	160V DC
Maximum Amperage per circuit	300A	240A	240A	300A	320A	160A	320A
Maximum Amperage per block	300A	--	300A	300A	320A	160A	320A
Available Fuses	30-300A	30-300A	30-300A	100-300A	225-400A	110-200A	225-400A
Ingress Protected	IP66 when used with Blue Sea Systems' Terminal (MRBF) Fuses.	--	--	--	--	--	--
Ignition Protected	--	SAE J1171 when used with Blue Sea Systems' MRBF fuses.		--	--	ISO 8846, SAE J1171 when cover is secure.	ISO 8846, SAE J1171 when cover is secure.

Product	ANL	ANL	Safety	SafetyHub 100	SafetyHub 150
					
Part #	5005	5503	7720 & 7721	7725	7748
Page Number	71	72	72	73	
For use with	ANL	ANL	7720: AMI or MIDI 7721: MEGA or AMG	AMI or MIDI and ATO or ATC	
Maximum Voltage	32V DC	32V DC	32V DC	12V DC	32V DC
Maximum Amperage per circuit	300A	750A	7720: 200A 7721: 300A	AMI or MIDI: 250A ATO or ATC: 30A	AMI or MIDI: 170A ATO or ATC: 25A
Maximum Amperage per block	300A	750A	7720: 200A 7721: 300A	ATO or ATC: 50A	AMI or MIDI: 280A ATO or ATC: 50A
Maximum Total Amperage (combined)	35-300A	--	--	280A	280A
Available Fuses	--	35-750A	7720: 30-200A 7721: 100-300A	AMI or MIDI: 30-200A ATO or ATC: 1-30A	AMI or MIDI: 30-200A ATO or ATC: 1-30A
Ingress Protected	--	--	--	IP66-protected against powerful water jets.	
Ignition Protected	--	--	--	ISO 8846, SAE J1171 when cover is secure.	

ST-CLB Circuit Breaker Blocks

Compact surface mount solution providing secure screw termination where Push Button Reset-Only CLB Circuit Breakers are desired

- Clear insulating cover with square format label recesses, satisfies ABYC/USCG insulation requirements
- Quick connect clips allow circuit breakers to snap easily into place
- Tin-plated copper busses and screw terminals
- Breakouts allow wire access in two directions
- Accepts ring terminals
- Optional push button waterproof boots or dress nuts can be installed over cover
- Accepts square labels
- Optional jumper 5049, for use with 5050 and 5051
- Circuit breakers sold separately (p. 77)

Voltage Max. Operating	32V DC
Amperage Max. Operating	32A (per circuit)
Amperage Max. Operating	100A (per block - common source)
Amperage Max. Operating	40A (per jumped circuit group - independent source)
Temp. Operating Range	-10°C to 60°C
Breaker Type	Push Button Reset-Only Circuit Breaker with Quick Connect Terminals
Screw Terminal	#8-32 Screws with Captive Star Lock Washer
Ring Terminals	Screw Terminals #8 (M4), Negative Bus #10 (M5)
Mounting	#8 Screw (M4) or #8 Nut

Part #	Positions	Negative Bus	Source	[A] Mounting Centers in (mm)	[B] Mounting Centers in (mm)	[C] Height in (mm)
5050	6	--	Independent	5.63 (142.9)	1.40 (35.6)	6.69 (169.9)
5051	12	--	Independent	10.13 (257.2)	1.71 (43.4)	11.19 (284.2)
5052	6	#10-32 stud	Common	5.63 (142.9)	1.40 (35.6)	6.69 (169.9)
5054	12	#10-32 stud	Common	10.13 (257.2)	1.71 (43.4)	11.19 (284.2)
5049	ST CLB Block Jumper, 5 per pack					

VIDEO
blueseaa.com/video

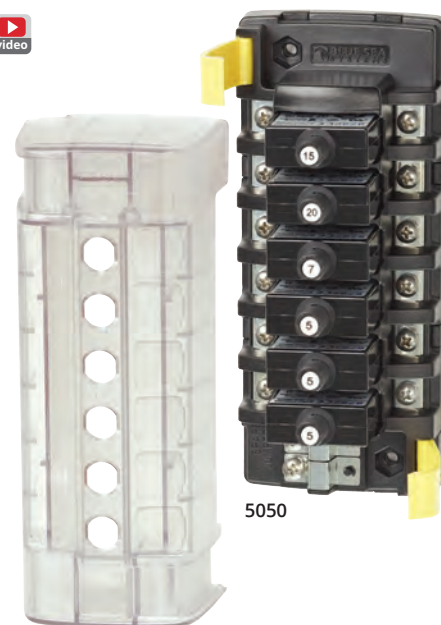

5050

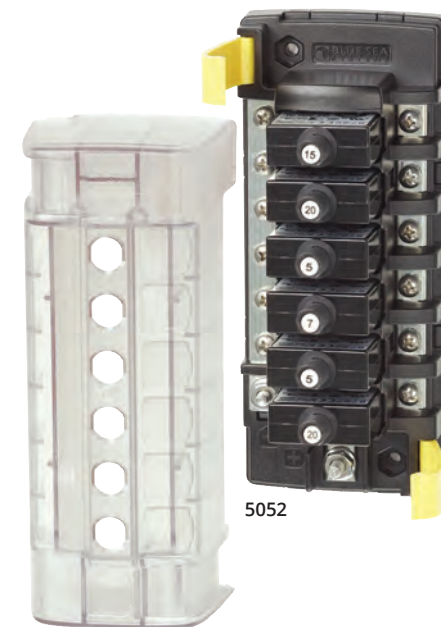

5052

Three Switched Circuits, Three 24-Hour Circuits

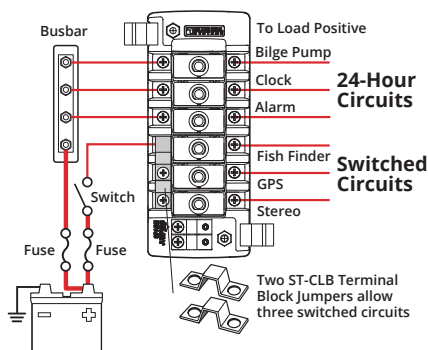

Six Switched or Six 24-Hour Circuits

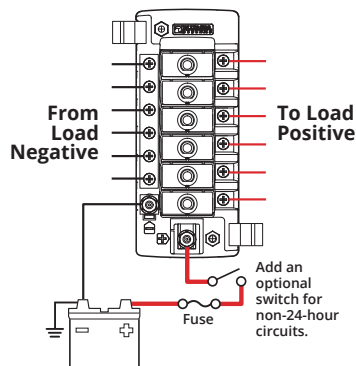

Related Products

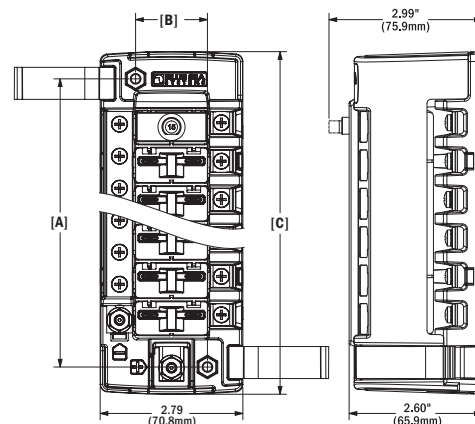

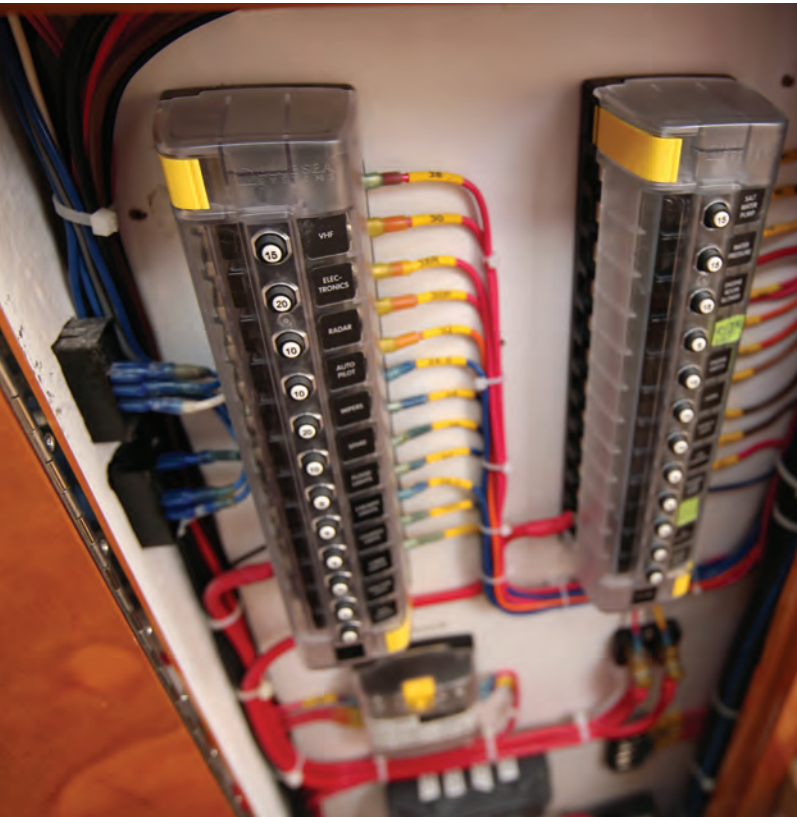

True North Yachts installs ST-CLB blocks aboard their boats, including the True North 38.

CLB Circuit Breaker Waterproof Boots

Protects push button circuit breakers in wet environments

- Used on waterproof panels (p. 116-117)
- Replaces dress nut mounting on circuit breakers

Thread Material	Nickel-Plated Brass
Thread	3/8"-27

Regulatory IP67 - protected against immersion up to 1 meter for 30 minutes



Part #	Description	Retail Pack
4135	Clear	2
4136	White	2
4137	Black	2

Related Products

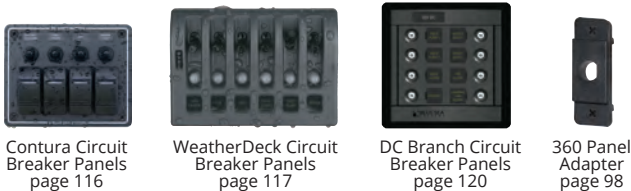

Contura Circuit Breaker Panels page 116

WeatherDeck Circuit Breaker Panels page 117

DC Branch Circuit Breaker Panels page 120

360 Panel Adapter page 98

Push Button Reset-Only CLB Circuit Breakers

Provides economical circuit protection for 3 to 40 Amp loads when switching is provided elsewhere or not required



- Quick connect or screw terminal style
- Compact design enables high density circuit protection configurations
- Push-to-reset operation
- Trip Free design cannot be held ON during fault current condition
- Optional push button waterproof boot

Interrupting Capacity	3,000A @ 14.7V DC / 2,500A @ 28V DC
Voltage Max. Operating	32V DC
Temperature Min. Operating	-10°C
Temperature Max. Operating	60°C
Type	Thermal trip, manual reset
Terminals	#8 Screw Terminals or 1/4" Male Quick Connect (QC) Terminals
Screw Terminal Torque	6 in-lb max.
Trip Time Delay	See blueseas.com
Thread	3/8"-27 UNS
Regulatory	CE marked UL Recognized - UL 1077 - UL/cUL (USA and Canada), TUV certified Meets UL 1500 and ISO 8846 external ignition protection requirements

IGNITION PROTECTED

Screw Terminals Part #	QC Terminals Part #	Amps
2129	7050	3A DC
2130	7052	5A DC
2131	7053	7A DC
2132	7054	10A DC
2133	7056	15A DC
2134	7057	20A DC
2135	7058	25A DC
2136	7059	30A DC
2137	7061	40A DC

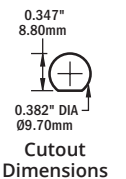

See p. 166 for ABYC Interrupting Capacity Requirements.

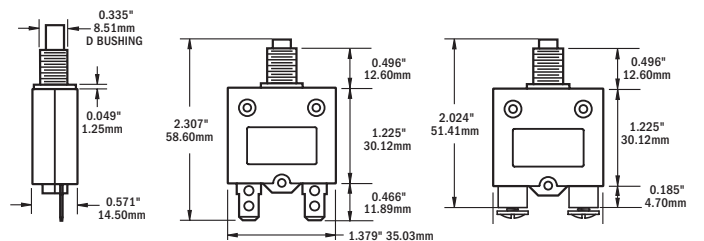

1/4" Male Quick Connect Terminals

#8 Screw Terminals

Medium Duty Push Button Reset-Only Circuit Breakers

Provides circuit protection for 15 to 60 Amp loads when switching is provided elsewhere or not required

- Weatherproof
- Can be used as Main or Branch
- Push-to-reset operation
- Trip Free design cannot be held ON during fault current condition
- Captive star lock washers meet requirements for anti-rotation and eliminate handling of small, easily dropped parts

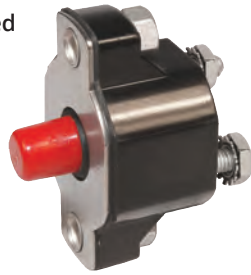

Interrupting Capacity	5,000A @ 32V DC 3,000A @ 120V AC
Voltage Max. Operating	32V DC / 120V AC
Temperature Min. Operating	-54°C
Temperature Max. Operating	74°C
Type	Thermal trip, manual reset
Terminal Stud	#10-32 Stainless Steel
Terminal Stud Torque	30 in-lb max.
Trip Time Delay	See blueseas.com
Mounting Thread	#8 -32

Regulatory
SAE J1428, SAE J553, UL 1077
Meets UL 1500 external ignition protection requirements

IGNITION PROTECTED

See p. 166 for ABYC Interrupting Capacity Requirements.

Part #	Amps
2138	15A DC
2139	20A DC
2140	30A DC
2141	40A DC
2142	50A DC
2143	60A DC

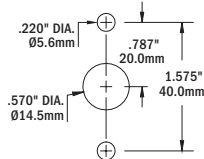

Cutout Dimensions

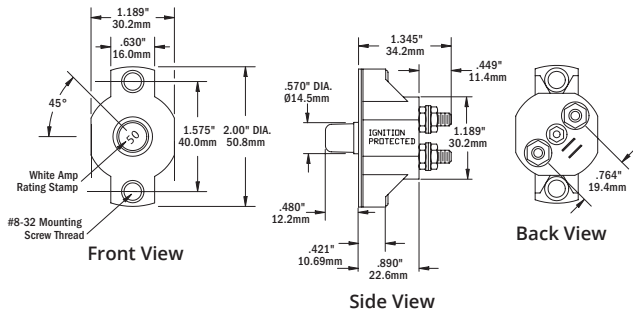

Marine Grade Short Stop Circuit Breakers

Use a circuit breaker instead of a fuse

- Designed with corrosion resistant materials to withstand harsh environments
- IP64 water resistant boot protects against dust and splashing water
- Push-to-reset operation only disconnects when tripped
- Stainless steel nyloc nuts for secure connections
- Red insulating boot included in retail package only



Interrupting Capacity	2,500A @ 28V DC
Voltage Max. Operating	28V DC
Temperature Min. Operating	-10°C
Temperature Max. Operating	60°C
Type	Thermal trip, manual reset
Terminals	#10-32" Studs
Screw Terminal Torque	24 in-lb max.
Trip Time Delay	See blueseas.com

Regulatory
IP64, SAE J553, Meets SAE J1171 external ignition protection requirements

IGNITION PROTECTED

See p. 166 for ABYC Interrupting Capacity Requirements.

Part #	Amps
7151	10A DC
7152	15A DC
7153	20A DC
7154	25A DC
7155	30A DC
7156	40A DC
7157	50A DC
7160	Insulating Boot



Shown with Insulating Boot

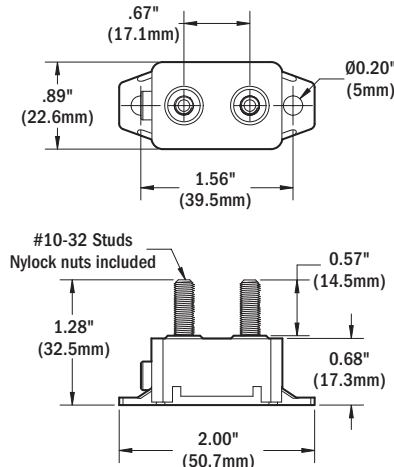

Push-Button to Reset

ATO®/ATC®-Style Low Profile Circuit Breakers **NEW**

Use a manually resettable circuit breaker instead of an ATO or ATC fuse

- Drop in replacement for ATO and ATC blade style fuses
- Manual push button reset complies with ABYC circuit protection requirements
- Compatible with Water-Resistant ST-Blade Fuse Block (5056) with cover secured (p. 64)
- Compatible with all other ST-Blade Fuse blocks without cover

Interrupting Capacity	2,000A @ 28V DC
Voltage Max. Operating	32V DC
Temperature Min. Operating	-40°C (-40°F)
Temperature Max. Operating	85°C (185°F)
Type	Thermal trip, manual reset
Trip Time Delay	See blueseas.com
Regulatory SAE J553, UL 1500, ISO 10924-4, Meets SAE J1171 external ignition protection requirements	

IGNITION PROTECTED

See p. 166 for ABYC Interrupting Capacity Requirements.

Part #	Amps	Color	Retail Pack
7062	5A	LT. Brown	2
7063	7.5A	Moss Green	2
7064	10A	Red	2
7065	15A	Blue	2
7066	20A	Yellow	2
7067	25A	White	2
7068	30A	Green	2

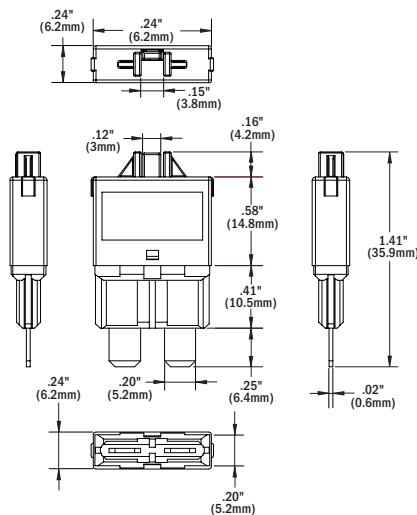

Related Products

NEW



ST-Blade Water-Resistant Fuse Block page 64



285-Series Circuit Breakers

Provides circuit protection for 25 to 150 Amp loads when switching and circuit protection are both required

- Visible yellow reset lever shows open condition
- Trip-free design cannot be held closed after trip
- Drop in replacement for 185 Series Circuit Breakers
- 3,000A AIC for medium battery banks



Main circuit protection for battery banks up to



Interrupting Capacity	3,000A @ 48V DC†
Voltage Max. Operating	48V DC
Temperature Min. Operating	-40°C (-40°F)
Temperature Max. Operating	85°C (185°F)
Type	Thermal
Class	Thermal Reset - Trip Free
Terminal Stud	M6 (accepts 1/4" Ring Terminal)
Terminal Stud Torque	50 in-lb (7.9 Nm)
Mounting Hole	Accepts 1/4" screw (M6)

Regulatory
 CE marked
 Meets SAE J1171 external ignition protection requirements, †AIC ratings achieved using SAE J1625
 IP67 – protected against immersion up to 1 meter for 30 minutes (see inside back cover)



See p. 166 for ABYC Interrupting Capacity Requirements.

Panel Mount Part #	Surface Mount Part #	Amps
7080	7180	25A DC
7081	7181	30A DC
7082	7182	40A DC
7083	7183	50A DC
7084	7184	60A DC
7085	7185	70A DC
7086	7186	80A DC
7087	7187	100A DC
7088	7188	120A DC
7089	7189	150A DC



7087

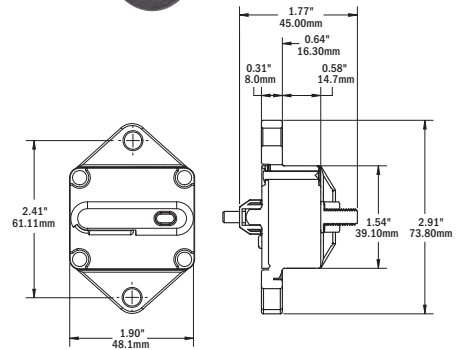

7187

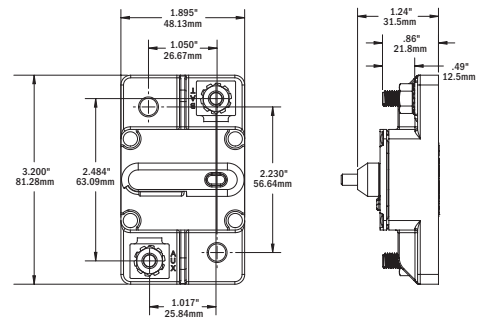

Circuit Breaker Mounting Options

Provides mounting for Cooper Bussmann® Klaxon, 285-Series or 185-Series Panel Mount Circuit Breakers

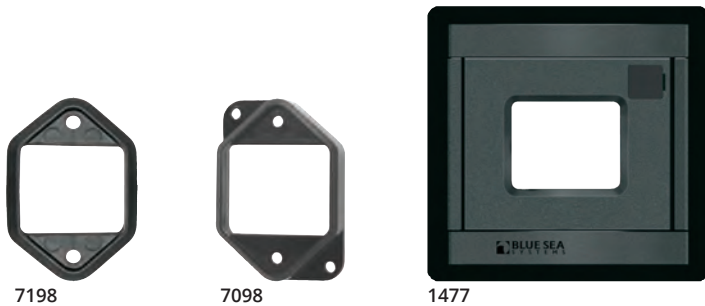

Part #	Description	Width in (mm)	Height in (mm)
7198	Self-trimming molded rubber bezel	2.44 (61.90)	3.31 (84.07)
7098	Circuit breaker adapter bezel allows circuit breaker mounting in a 2-1/8" round hole	2.44 (61.90)	3.31 (84.07)
1477	Provides circuit breaker mounting in the 360 Panel System	4.88 (123.83)	4.75 (120.65)

Related Products



2719 Enclosure
page 104

187-Series Circuit Breakers

Provides circuit protection for 25 to 200 Amp loads when switching and circuit protection are both required

- Self-trimming case eliminates need for mounting panels or trim bezels
- Visible yellow reset lever shows open condition
- Trip-free design cannot be held closed after trip
- Large clearance around terminal studs accepts up to 1/0 AWG lugs
- Recessed mounting holes for clean appearance
- Robust 5/16"-18 terminals provide high torque connections
- 5,000A AIC for large battery banks



Main circuit protection for battery banks up to



7044

Interrupting Capacity	5,000A @ 14V DC 3,000A @ 28V DC 1,500A @ 48V DC
Voltage Max. Operating	48V DC
Temperature Min. Operating	-40°C (-40°F)
Temperature Max. Operating	85°C (185°F)
Type	Thermal
Class	Type III - Switchable/Manual Reset - Trip Free
Terminal Stud	5/16"-18
Terminal Stud Torque	75 in-lb max.
Trip Time Delay	See bluesease.com
Mounting Hole	Accepts #10 (M5) Screw
Regulatory	
	CE marked
	Meets SAE J1171 external ignition protection requirements
	IP66 - protected against powerful water jets (see inside back cover)

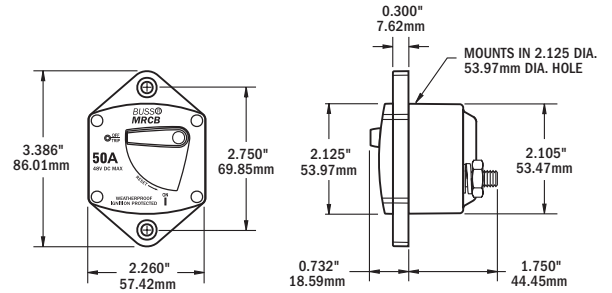

IGNITION PROTECTED

See p. 166 for ABYC Interrupting Capacity Requirements.

Panel Mount Part #	Surface Mount Part #	Amps
7035	7135	25A DC
7036	7136	30A DC
7038	7138	40A DC
7039	7139	50A DC
7040	7140	60A DC
7041	7141	70A DC
7042	7142	80A DC
7043	7143	90A DC
7044	7144	100A DC
7046	7146	120A DC
7047	7147	135A DC
7048	7148	150A DC
7049	7149	200A DC



7140

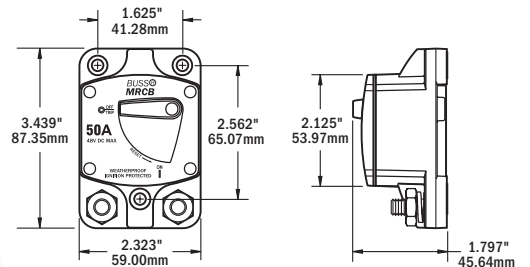

Grady White uses Blue Sea Systems 187 Series Thermal Circuit Breakers aboard their boats, including the Express 306.

COTS Circuit Breakers Water-Resistant

Suitable for use when government specifications are required

Interrupting Capacity	7500A DC / 1,500A AC
Voltage Max. Operating	65V DC / 277V AC
Temperature Operating	-40°C to 85°C (-40°F-185°F)
Switching Cycles	6000 Electrical, 4000 Mechanical
Type	Magnetic Hydraulic - Trip free A-Series, Metal Toggle
Terminal Screw	#10-32 SS
Terminal Screw Torque	14-15 in-lb
Mounting Screw	#6-32 SS
Mounting Screw Torque	7-9 in/lb
Mounting Boss	1/2-32 Hex Nut SS
Mounting Nut Torque	30 in-lb max.

Regulatory
 UL 1077, CSA certified
 Water Resistant - designed and tested in accordance with the MIL-PRF-55629 and MIL-STD-202 specifications



7312

Part #	Amps	Poles	Actuator Style
7310	5A	2	Toggle
7311	10A	2	Toggle
7312	15A	2	Toggle
7313	20A	2	Toggle
7314	25A	2	Toggle
7315	30A	2	Toggle
7316	40A	2	Toggle
7317	50A	2	Toggle

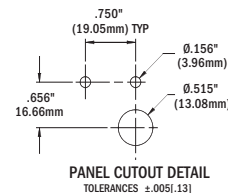
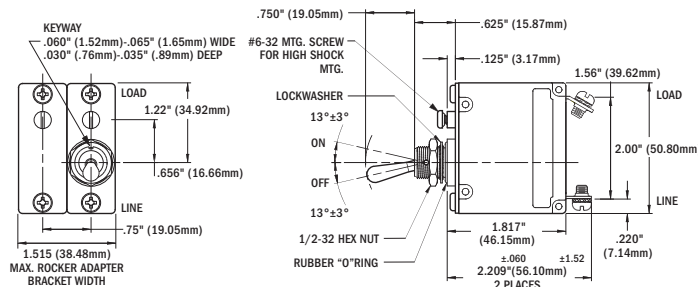

Metal Shark boats builds custom aluminum boats for government agencies. The Custom 360 Panel with Mil-Spec Toggle Circuit Breakers is housed inside the center console and distributes power to critical loads aboard the Defiant 29.



UL-489 Circuit Breakers

Expanded line of circuit breakers that meet CFR 46 / CoastGuard requirements

	7440-7446	7454-7459	7461-7467
Interrupting Capacity	10,000A	5000A	5000A
Voltage Max. Operating	80V DC	240V AC	240V AC
Temperature Operating	-40°C to 85°C (-40°F-185°F)	-40°C to 85°C (-40°F-185°F)	-40°C to 85°C (-40°F-185°F)
Type	C-Series, Magnetic Hydraulic - Trip free	C-Series, Magnetic Hydraulic - Trip free	C-Series, Magnetic Hydraulic - Trip free
Terminal	#10-32 Screw* Tin-Plated Brass	#10-32 Screw Tin-Plated Brass	1/4"-20 Stud Tin-Plated Brass
Terminal Torque	15-20 in-lb*	15-20 in-lb	35 in-lb
Mounting Screw	#6-32 SS	#6-32 SS	#6-32 SS
Mounting Screw Torque	7-9 in-lb	7-9 in-lb	7-9 in-lb

Regulatory
UL 489, CSA certified, TUV certified.

* 7446 - Terminal - 1/4"-20 Stud, Terminal Torque - 30-35 in-lb

Part #	Amps	Poles	Actuator Style	Part #	Amps	Poles	Actuator Style
7440	5A DC	1	Flat Rocker	7454	5A AC	1	Flat Rocker
7441	10A DC	1	Flat Rocker	7455	10A AC	1	Flat Rocker
7442	15A DC	1	Flat Rocker	7456	15A AC	1	Flat Rocker
7443	20A DC	1	Flat Rocker	7457	20A AC	1	Flat Rocker
7444	30A DC	1	Flat Rocker	7458	30A AC	1	Flat Rocker
7445	50A DC	1	Flat Rocker	7459	50A AC	1	Flat Rocker
7446	100A DC	1	Flat Rocker				

Part #	Amps	Poles	Actuator Style
7461	10A AC	2	Flat Rocker
7462	15A AC	2	Flat Rocker
7463	20A AC	2	Flat Rocker
7464	25A AC	2	Flat Rocker
7465	30A AC	2	Flat Rocker
7466	30A AC	2	Raised Rocker
7467	50A AC	2	Raised Rocker

Related Products



SMS Panel Enclosures page 90



7440



7454



7464



7466

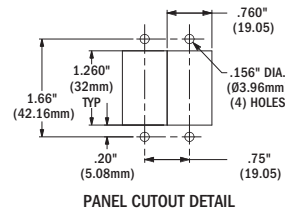
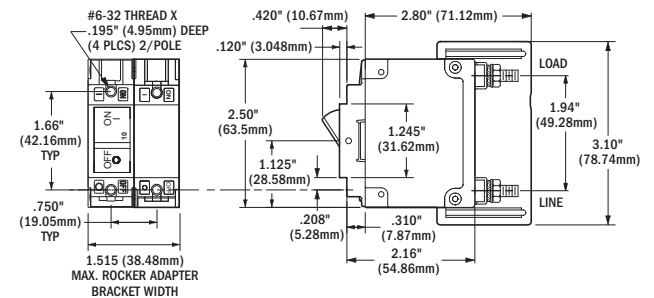
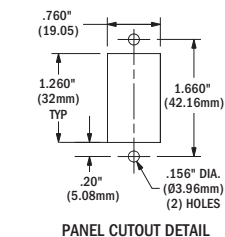
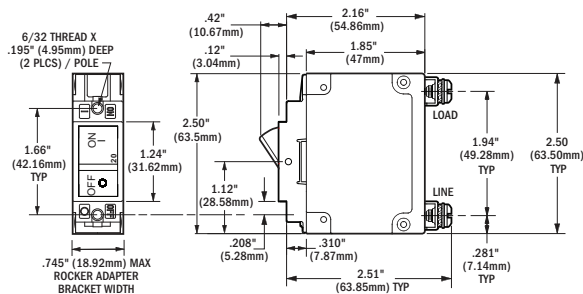

A-Series Toggle Circuit Breakers

Combines switching and circuit protection into a single device



- The standard circuit breaker for Blue Sea Systems Traditional Metal Power Distribution Panels
- Single pole is frequently used for AC or DC Branch circuit protection
- Double pole is typically used for AC Main circuit protection
- Trip Free – cannot be held closed after trip

Voltage Nominal Operating	120/240V AC
Temperature Min. Operating	-40°C (-40°F)
Temperature Max. Operating	85°C (185°F)
Switching Cycles	10,000 @ rated amps and volts
Type	Magnetic Hydraulic – Trip free
Terminal Screw	#10-32 Stainless Steel
Terminal Screw Torque	14–15 in-lb Recommended
Trip Time Delay	See blueseas.com
Mounting Screw	#6-32 Stainless Steel (included)
Mounting Nut Torque	6–8 in-lb Recommended
Regulatory	
CE marked, TUV certified, CSA certified, UL 1077 recognized	

Part #	Color	Amps	Poles	Max V DC	Part #	Color	Amps	Poles	Max V DC
7197	White	2.5A	1	32V DC	7232	Black	10A	2	65V DC
7200	Black	5A	1	32V DC	7233	White	10A	2	65V DC
7201	Red	5A	1	32V DC	7234	Black	15A	2	32V DC
7202	White	5A	1	65V DC	7235	White	15A	2	65V DC
7347	Black	8A	1	65V DC	7348	Black	16A	2	65V DC
7299	White	8A	1	65V DC	7294	White	16A	2	65V DC
7204	Black	10A	1	65V DC	7236	Black	20A	2	32V DC
7205	Red	10A	1	65V DC	7260	White	20A	2	32V DC
7206	White	10A	1	65V DC	7237	Black	30A	2	32V DC
7208	Black	15A	1	32V DC	7238	White	30A	2	65V DC
7209	Red	15A	1	32V DC	7349	Black	32A	2	65V DC
7210	White	15A	1	65V DC	7295	White	32A	2	65V DC
7212	Black	20A	1	65V DC	7239	Black	40A	2	65V DC
7213	Red	20A	1	32V DC	7240	White	40A	2	32V DC
7214	White	20A	1	65V DC	7241	Black	50A	2	65V DC
7216	Black	25A	1	65V DC	7242	White	50A	2	65V DC
7217	Red	25A	1	65V DC					
7218	White	25A	1	65V DC					
7220	Black	30A	1	32V DC					
7221	Red	30A	1	65V DC					
7222	White	30A	1	65V DC					
7224	Black	40A	1	65V DC					
7225	Red	40A	1	65V DC					
7226	White	40A	1	32V DC					
7228	Black	50A	1	32V DC					
7229	Red	50A	1	65V DC					
7230	White	50A	1	32V DC					

Interrupting Capacity Table (see ABYC Requirements p. 166)

	UL 1077 - UL/CSA (US/Canada)		EN60934 - TUV (Europe)
	DC Interrupt	AC Interrupt	AC Interrupt
1 Pole	7500A	3000A	1500A
2 Pole	7500A	3000A	1500A

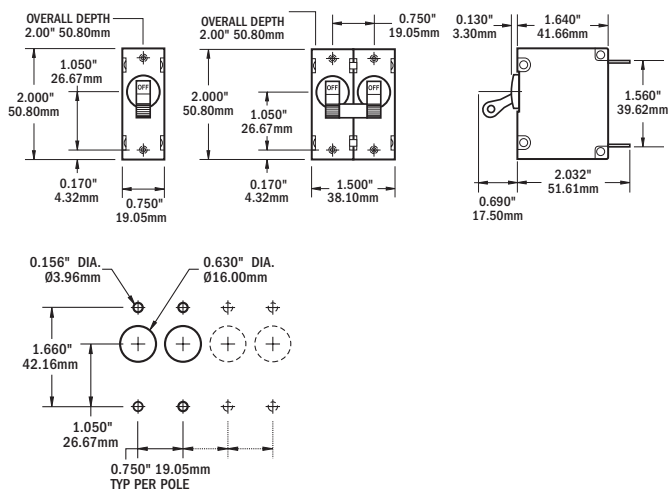

Cutout Dimensions

Related Products



360 Panel System page 118



Traditional Metal Panel page 119

Circuit Breaker Mounting Options

- 3131 enclosure, strain reliefs included for secure installation of circuit breakers
- 3131 enclosure, accepts A-Series Toggle and A and C-Series
- Flat Rocker Circuit Breakers, LEDs (p. 155), and Square Format Labels (p. 156) for custom configurations
- 8072 and 8173 panels, accept A-Series Toggle Circuit Breakers, Large Format Labels (p. 156) and LEDs (p. 155)



3131



8072



8173

Part #	Description	Width in (mm)	Height in (mm)	Depth in (mm)
3131	Circuit breaker enclosure	3.95 (100.36)	4.92 (124.91)	4.07 (103.40)
8072	Single pole mounting panel	2.63 (66.80)	3.75 (92.25)	0.125 (3.175)
8173	Double pole mounting panel	2.63 (66.80)	3.75 (92.25)	0.125 (3.175)

A-Series Rocker Circuit Breakers

Combines switching and circuit protection into a single device



7403

Flat Rocker

- Standard circuit breaker used on the 360 Panel System (1200 Series)
- Flat actuator resists accidental switching by being flush in the ON position

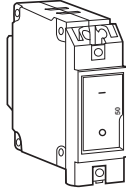

7425

Restricted-OFF Rocker

- Actuator shows white in the OFF position
- Restricted OFF actuator can only be switched to OFF by insertion of small screwdriver into slot

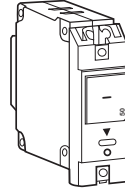

7574

Raised Rocker

- Standard circuit breaker for AC Source Select panels in the 360 Panel System

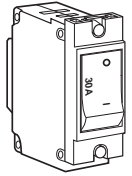

- White actuator indicates OFF position
- Single pole is available in Flat Rocker and Restricted Off styles
- Single pole is frequently used for AC or DC Branch circuit protection
- Double pole is available in Flat Rocker and Raised Rocker styles
- Double pole is typically used for AC Main circuit protection
- Raised Rocker actuator style is used for AC source selection on the 360 Panel System
- International ON and OFF symbols support vertical or horizontal mounting

Voltage Nominal Operating	120/240V AC
Temperature Min. Operating	-40°C (-40°F)
Temperature Max. Operating	85°C (185°F)
Switching Cycles	10,000 @ rated amps and volts
Type	Magnetic Hydraulic – Trip free
Terminal Screw	#10-32 Stainless Steel
Terminal Screw Torque	14–15 in-lb Recommended
Trip Time Delay	See blueseas.com
Mounting Screw	#6-32 Stainless Steel (included)
Mounting Nut Torque	6–8 in-lb Recommended
Regulatory	
CE marked, TUV certified, CSA certified, UL 1077 recognized	

Part #	Amps	Max V DC	Poles	Rocker Actuator
7399	2.5A	32V DC	1	Flat
7400	5A	32V DC	1	Flat
7425	5A	32V DC	1	Restricted-OFF
7401	8A	32V DC	1	Flat
7402	10A	32V DC	1	Flat
7427	10A	32V DC	1	Restricted-OFF
7403	15A	32V DC	1	Flat
7428	15A	32V DC	1	Restricted-OFF
7404	20A	32V DC	1	Flat
7429	20A	32V DC	1	Restricted-OFF
7405	25A	32V DC	1	Flat
7430	25A	32V DC	1	Restricted-OFF
7406	30A	32V DC	1	Flat
7407	40A	32V DC	1	Flat
7408	50A	32V DC	1	Flat
7433	50A	32V DC	1	Restricted-OFF

Part #	Amps	Max V DC	Poles	Rocker Actuator
7410	10A	32V DC	2	Flat
7411	15A	32V DC	2	Flat
7412	16A	32V DC	2	Flat
7413	20A	32V DC	2	Flat
7574	30A	32V DC	2	Raised
7414	30A	32V DC	2	Flat
7575	32A	32V DC	2	Raised
7415	32A	32V DC	2	Flat
7416	40A	32V DC	2	Flat
7577	50A	32V DC	2	Raised
7417	50A	32V DC	2	Flat

Interrupting Capacity Table (see ABYC Requirements p. 166)

	UL 1077 - UL/CSA (US/Canada)			EN60934 - TUV (Europe)
	DC Interrupt	120V AC Interrupt	240V AC Interrupt	AC Interrupt
1 Pole	5000A	3000A	1500A	1500A
2 Pole	5000A	3000A	3000A	1500A

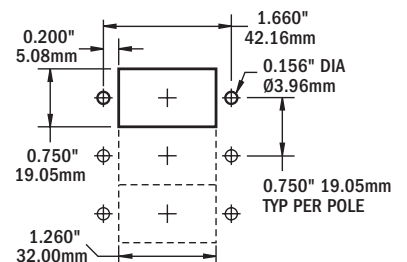
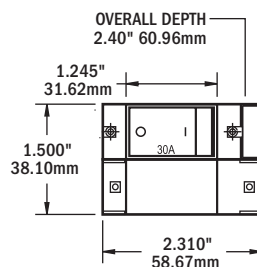
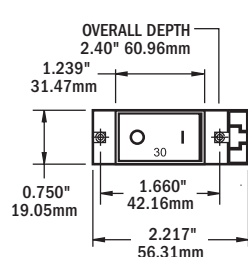

Cutout Dimensions

Related Products



360 Panel System
page 118

C-Series Toggle Circuit Breakers

Combines switching and circuit protection into a single device



7250*



7250I



7267



7270



7251



7287

DC Features

- Large frame provides stud termination for 5–300 Amp loads
- Provides overcurrent protection for inverters, bow thrusters, and windlasses
- Offers high interrupt capacity – suitable for Main circuit protection
- Trip Free – cannot be held closed after trip

AC Features

- Frequently used for 120/240 Volt AC circuit protection
- Double pole can be used as AC Main circuit breaker to switch hot and neutral or two hots in 120/240 Volt AC Branch applications
- Triple pole can be used as 120/240 Volt AC Main circuit breaker to switch both lines (hots) and neutral
- Double and triple pole circuit breakers will trip all poles if any one pole trips

Voltage Nominal Operating	120/240V AC
Temperature Min. Operating	-40°C (-40°F)
Temperature Max. Operating	85°C (185°F)
Switching Cycles	10,000 @ rated amps and volts
Type	Magnetic Hydraulic – Trip free
Terminal Stud	1/4"-20 Tin-Plated Brass
Terminal Stud Torque	35 in-lb max.
Trip Time Delay	See blueseas.com
Mounting Screw	#6-32 Stainless Steel (included)
Mounting Screw Torque	6–8 in-lb Recommended

Regulatory

7250I Only – meets SAE J1171, UL 1500, and ISO 8846 external ignition protection requirements

IGNITION PROTECTED

Interrupting Capacity Table (see ABYC Requirements (p. 166))

	UL 1077 - UL/CSA (US/Canada)		EN60934 - TUV (Europe)
	DC Interrupt	AC Interrupt	AC Interrupt
1 Pole	10000A	5000A	5000A
1 Pole 7250I	5000A	1500A	--
2 & 3 Pole	5000A	5000A	5000A

Related Product



Traditional Metal 7372
page 127

Part #	Color	Amps	Poles	Max V DC
7350	White	5A DC	1	80V DC
7351	White	10A DC	1	80V DC
7352	White	15A DC	1	80V DC
7353	White	20A DC	1	80V DC
7354	White	25A DC	1	80V DC
7355	White	30A DC	1	80V DC
7244	White	50A DC	1	80V DC
7246	White	60A DC	1	80V DC
7248	White	80A DC	1	65V DC
7250	White	100A DC	1	65V DC
7250I	Red	100A DC	1	48V DC

Part #	Color	Amps	Poles	Max V DC
7365	White	30A AC	2	80V DC
7251	White	50A AC	2	80V DC
7254	White	60A AC	2	80V DC
7256	White	80A AC	2	80V DC
7258	White	100A AC	2	65V DC
7267*	White	150A DC	2	65V DC
7268*	White	175A DC	2	65V DC
7269*	White	200A DC	2	65V DC

Part #	Color	Amps	Poles	Max V DC
7287	White	50A AC	3	80V DC
7288	White	60A AC	3	80V DC
7289	White	80A AC	3	80V DC
7290	White	100A AC	3	80V DC
7270*	White	250A DC	3	65V DC
7271*	White	300A DC	3	65V DC

* Paralleled poles have 5/16" stud on bus

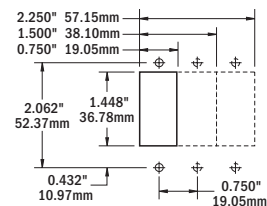
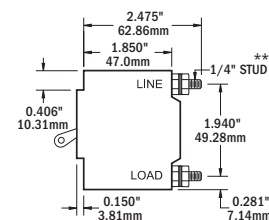
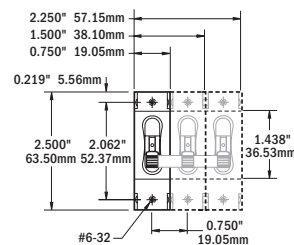

Cutout Dimensions

C-Series Toggle Circuit Breaker Mounting Panels

Simplifies mounting C-Series Toggle Circuit Breakers

- Accepts Blue Sea Systems Large Format Labels and ON indicating LEDs
- Panel plugs can be inserted to fill blank positions
- Panel Plug Kit 8089 included – circuit breaker mounting screws, panel plug, LED plug and blank label

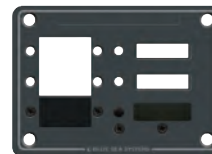

8088

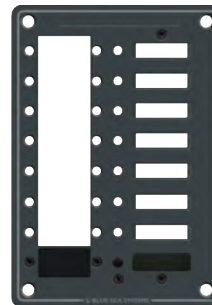

8087

Part #	Description	Width in (mm)	Depth in (mm)
8088	3 position	5.25 (133.35)	3.75 (95.25)
8087	8 position	5.25 (133.35)	7.50 (190.50)
8089	Panel Plug Kit	--	--

C-Series Rocker Circuit Breakers

Combines switching and circuit protection into a single device



DC Features

- White actuator indicates OFF position
- Large frame provides stud termination for 5-300 Amp loads
- Flat rocker actuator is flush in the ON position, reducing the risk of accidental switching
- Provides overcurrent protection for inverters, bow thrusters, and windlasses
- Trip Free – cannot be held closed after trip

Voltage Nominal Operating	120/240V AC
Temperature Min. Operating	-40°C (-40°F)
Temperature Max. Operating	85°C (185°F)
Switching Cycles	10,000 @ rated amps and volts
Type	Magnetic Hydraulic – Trip free
Terminal Stud	1/4"-20 Tin-Plated Brass
Terminal Stud Torque	35 in-lb max.
Trip Time Delay	See bluesease.com
Mounting Screw	#6-32 Stainless Steel (included)
Mounting Screw Torque	6-8 in-lb Recommended

Regulatory

Single-pole circuit breakers only – CE marked, meet SAE J1171, UL 1500 and ISO 8846 external ignition protection requirements, CSA certified, and UL 1077 recognized
AC Circuit breakers only – TUV certified, CSA certified, and UL 1077 recognized
AC and AC/DC Circuit breakers only – CE marked

IGNITION PROTECTED

Interrupting Capacity Table (see ABYC Requirements (p. 166))

	Volts	Amps	UL 1077 - UL/CSA (US/Canada)	EN60934 - TUV (Europe)
			Interrupt	Interrupt
1 Pole	32V DC	5-100A	5,000A	--
	120V AC	5-100A	3,000A	--
	240V AC	5-50A	3,500A	--
2 and 3 Pole	48V DC	150-300A	5,000A	--
	48V DC	150-200A	--	5,000A
	120/240V AC	30-100A	5,000A	--
	240V AC	30-100A	--	5,000A

AC Features

- Used for 120/240 Volt AC circuit protection
- Double pole can be used as AC Main circuit breaker to switch hot and neutral or two hots in 120/240 Volt AC Branch applications
- Triple pole can be used as 120/240 Volt AC Main circuit breaker to switch both lines (hots) and neutral
- Double and triple pole circuit breakers will trip all poles if any one pole trips

Part #	Amps	Max V DC	Poles	Actuator
7540	5A DC	48V DC	1	Flat
7541	10A DC	48V DC	1	Flat
7542	15A DC	48V DC	1	Flat
7543	20A DC	48V DC	1	Flat
7545	30A DC	48V DC	1	Flat
7546	50A DC	48V DC	1	Flat
7547	60A DC	48V DC	1	Flat
7548	80A DC	48V DC	1	Flat
7549	100A DC	48V DC	1	Flat

Part #	Amps	Max V DC	Poles	Actuator
7560	30A AC	--	2	Flat
7580	30A AC	--	2	Raised
7561	50A AC	--	2	Flat
7581	50A AC	--	2	Raised
7563	80A AC	--	2	Flat
7583	80A AC	--	2	Raised
7564	100A AC	--	2	Flat
7584	100A AC	--	2	Raised
7475*	150A DC	48V DC	2	Flat
7476*	200A DC	48V DC	2	Flat

Part #	Amps	Max V DC	Poles	Actuator
7565	50A AC	--	3	Flat
7585	50A AC	--	3	Raised
7568	50A AC	--	3	Flat
7588	100A AC	--	3	Raised
7477*	250A DC	48V DC	3	Flat
7554*	300A DC	48V DC	3	Flat

* Paralleled poles have 5/16" stud on bus

Related Product



360 Panel System 1168 page 127

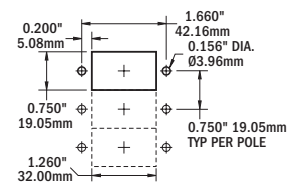
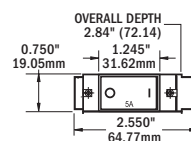
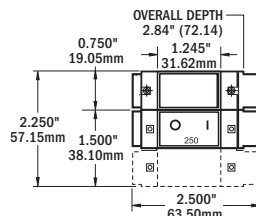

Cutout Dimensions

TECH tip™

AC Ground Faults ELCI, the Boater and ABYC

Understanding Equipment Leakage Circuit Interrupters (ELCIs) and Ground Fault Circuit Interrupters (GFCIs) to make your boat safer. There are two potential failures in a boat's electrical system that can put people on or around the boat at risk of lethal electric shock.

In a properly functioning marine electrical system, the same amount of AC current flows in the hot and neutral wires.

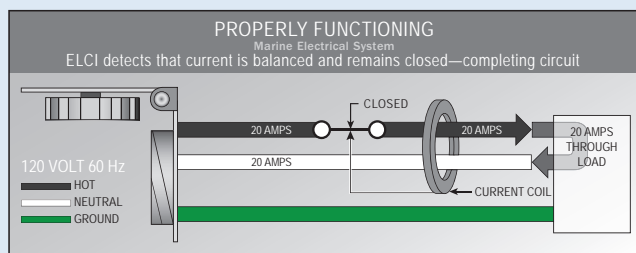

However, if electricity "leaks" from this intended path in these two wires to ground, this condition is called a ground fault. An example of this is an insulation failure in the wiring of an appliance.

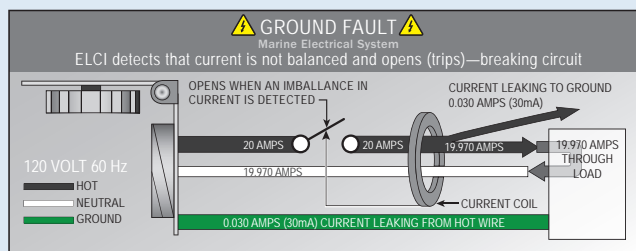

In addition, a faulty ground can occur when the grounding path is broken through a loose connection or broken wire. For instance, a shore power cord ground wire may fail due to constant motion and stress.

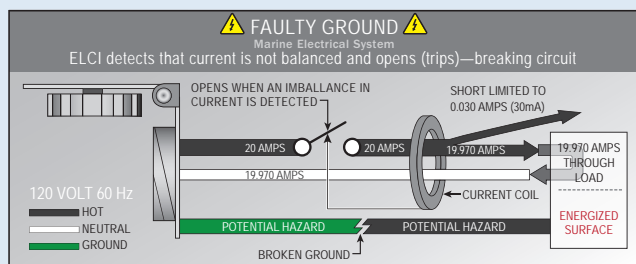

Faulty grounds can be undetectable; a simple continuity test will not necessarily reveal a problem. When these two conditions occur at the same time, the results may be tragic.

The combination of a ground fault and a faulty ground can result in metal parts on the boat and under water becoming energized. If an electric drill with faulty internal wiring or a worn cord falls into the bilge, the water in the bilge will become energized, putting the worker and those nearby at risk.

In addition to the hazard to people on the vessel, there is a larger danger to swimmers near the boat. While people on board are likely to receive a shock from touching energized metal parts, nearby swimmers could receive a paralyzing dose of electricity and drown due to involuntary loss of muscle control.

A Coast Guard sponsored study showed numerous instances of electrical leakage causing drowning or potential drowning even though the shock did not directly cause electrocution.

Given the seriousness of the problem, ABYC requirements now include specific measures for avoiding this danger:

ABYC E-11.13.3.5 states:

If installed in a head, galley, machinery space, or on a weather deck, the receptacle shall be protected by a Type A (nominal 5 milliamperes) Ground Fault Circuit Interrupter (GFCI).

ABYC E-11.11.1 states:

An Equipment Leakage Circuit Interrupter (ELCI) shall be installed with or in addition to the main shore power disconnect circuit breaker(s) or at the additional overcurrent protection as required by E-11.10.2.8.3 whichever is closer to the shore power connection.

ELCIs, and the more familiar GFCIs (Ground Fault Circuit Interrupter), are part of a larger family of devices that measure current flow in the hot and neutral wires and immediately switch the electricity off if an imbalance of current flow is detected. ELCIs and GFCIs that are also RCBOs (Residual Current Circuit Breaker) provide overcurrent tripping protection characteristic of a normal circuit breaker.

GFCIs are used as branch circuit ground fault protection at the 5mA threshold in potentially wet environments. GFCIs protect against flaws in devices plugged into them, but offer no protection from the danger of a failing hard-wired appliance, such as a water heater or cook top.

In contrast, an ELCI provides additional whole-boat protection. Installed as required within 10' of the shore power inlet, an ELCI provides 30mA ground fault protection for the entire AC shore power system beyond the ELCI. ABYC regulations still require the use of GFCIs in environments described above.

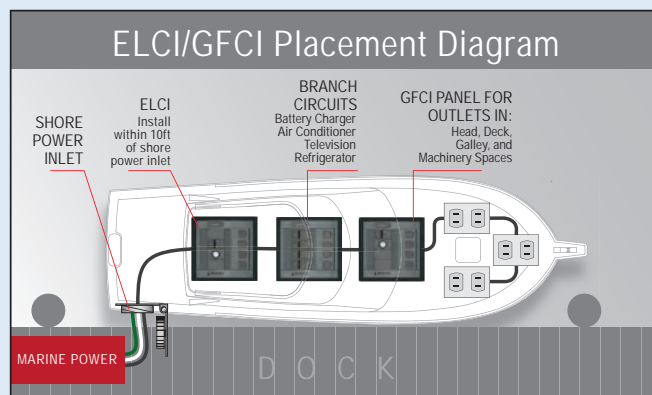

Although ABYC regulations apply only to new boat construction, ELCIs can mitigate dangers and liabilities that exist for any boat owner with a shore power connection. Retrofitting an ELCI to an existing AC system can be a worthwhile safeguard against risk. Since an ELCI/RCBO can serve as the main shore power circuit breaker, it can replace a standard circuit breaker in this application. Alternatively, an ELCI/RCBO can be added between the shore power inlet and the existing main shore power circuit breaker. Safety ground system failures on boats are safety and liability disasters waiting to happen. ELCI protection on each shore power line, combined with protection afforded by GFCIs, will reduce risk to those on the boat, the dock, and in the water surrounding the boat.

*The ABYC has an exemption to this rule if an isolation transformer is used. See E-11 for specific information regarding the exemption.

Residual Current Circuit Breakers

Equipment Circuit Interrupter (ELCI) Main

Residual Current Devices (RCDs) respond to leakage of electrical current outside of the intended circuit path.

When the RCD function is combined with a circuit breaker for over current protection, the device is often referred to as an RCBO. In the USA, a device that trips on leakages of nominally 5mA and meets certain standards is called a Ground Fault Circuit Interrupter (GFCI). A device meeting the same standards but with a trip level of 30mA is called an Equipment Leakage Circuit Interrupter (ELCI). The devices below provide ELCI Main functions and circuit protection in panel mounted breakers.

- Trips on short circuit, overload, or leakage to ground
- For installation in a power distribution panel
- Provides overcurrent and leakage protection per ABYC E-11 for whole boat shore power protection

Interrupting Capacity	5,000A
Temperature Min. Operating	-35°C
Temperature Max. Operating	66°C
Switching Cycles	10,000 @ rated amps and volts
Type	Magnetic Hydraulic - Trip free
Mounting Screw	#6-32 Stainless Steel (included)
Mounting Screw Torque	6-8 in-lb Recommended
Regulatory	
UL 1077, UL 943 Class A, UL 1500	

IGNITION PROTECTED

Part #	Description	Frame Series	Nominal Voltage	Actuator	Poles	AC Main Amps	Leakage Trip Amps
3102100	ELCI Main	A-Series	120V AC per pole	Flat Rocker	2	30A	30mA
3103	ELCI Main	C-Series	120V AC per pole	Flat Rocker	2	50A	30mA
3104	ELCI Main	C-Series	120/240V AC per pole	Flat Rocker	3	50A	30mA
3106100	ELCI Main	A-Series	120V AC per pole	White Toggle	2	30A	30mA
3091	ELCI Main	C-Series	230V AC per pole*	Flat Rocker	2	16A	30mA
3092	ELCI Main	C-Series	230V AC per pole*	Flat Rocker	2	32A	30mA
3093	ELCI Main	C-Series	240V AC per pole†	Flat Rocker	2	50A	30mA

* 230V AC, Typical of Europe

† 240V AC, For isolation transformer applications



3102100



3103, 3091, 3092, 3093



3104



3106100

Related Products

NEW



SMS Surface Mount System page 90



Residual Current Circuit Breaker ELCI Main Panels page 128

SMS Surface Mount System Panel Enclosure

**EXPANDED
OFFERING**

Panel enclosure for ELCI Main circuit breakers and other large frame devices. Meets ABYC E-11 when used with an ELCI Main circuit breaker and mounted within 10 feet of the shore power inlet

- Blank apertures for custom breaker loading
- Clear cover allows easy view of circuit breaker status
- Blank circuit positions accommodate Carling Technologies™ A and C Series Flat Rocker and ELCI Main circuit breakers
- Stainless steel mounting hardware included

Enclosure Size	6.0" x 6.0" x 4.0" 152 mm x 152 mm x 102 mm
Exterior Overall Dimensions	7.6" x 7.4" x 4.7" 192 mm x 188 mm x 120 mm
Temperature Range	-40°C (-40°F) to 85°C (185°F)
Cover Screws and Hardware	10-32 stainless steel
Mounting Hardware	Ø 1/4", #12, (6 mm)

Regulatory

IP66 – Protected against powerful water jets when cover is latched (see inside back cover)
Flammability rating – Per UL 508,
Toxicity – Non-toxic, halogen free, RoHS compliant
UL Listed and NEMA 4X rated, NEMA Type 4, 4X, 6, 6P, 12, and 13

Interrupting Capacity Table (see ABYC Requirements (p. 166))



3120

NOTE: SMS panel enclosures are pre-assembled and ready for wire connections. Customers must select wire and entry or exit locations, drill holes, and install the appropriate glands.



Part #	3113	3116	3121	3117
Description	6 blank positions	ELCI Main + 3 blank positions	ELCI Main + 2 blank positions	120V AC ELCI 30A Dual
Circuit Breakers Installed	--	1 × ELCI Main 120V, 30A, 30mA (3102)	1 × ELCI Main 230V, 16A, 30mA (3091)	2 × ELCI Main 120V 30A, 30mA (3102)
Glands Included	--	2 × (3124) 3 × (3125)	3 × green ON 120V AC (8034) 1 × red Reverse Polarity 120V AC (8066)	2 × (3124) 4 × (3125)
LEDs Installed	--	4 × green ON 120V AC (8034) 1 × red Reverse Polarity 120V AC (8066)	3 × green ON 120V AC (8034) 1 × red Reverse Polarity 120V AC (8066)	2 × green ON indicating 120V AC (8034) 2 × red Reverse Polarity 120V AC (8066)
Labels Included	30 Basic DC (4205) 30 Basic AC (4206) Panel Voltage ID	1 × AC Main, 1 Reverse Polarity 1 × ELCI, 30 Basic AC (4206) Panel Voltage ID	1 × AC Main, 1 Reverse Polarity 1 × ELCI, 30 Basic AC (4206) Panel Voltage ID	Source Selection label Set - 10 labels 2 × Reverse Polarity, 2 ELCI Panel Voltage ID



Part #	3118	3123	3119	3120
Total Positions	ELCI Main + 2 blank positions		ELCI Main + 1 blank position	ELCI Main + 2 blank positions
Circuit Breakers Installed	1 × ELCI Main 120V 50A, 30mA (3103)	1 × ELCI Main 230V 32A, 30mA (3092)	1 × ELCI Main 120/240V, 50A, 30mA (3104)	1 × ELCI Main 240V, 50A, 30mA (3093)
Glands Included	2 × (3124) 1 × (3125) 2 × (3126)	2 × (3124) 1 × (3125) 2 × (3126)	2 × (3124) 1 × (3125) 2 × (3126)	2 × (3124) 1 × (3125) 2 × (3126)
LEDs Installed	3 × green ON indicating 120V AC (8034) 1 × red "Reverse Polarity" 120V AC (8066)	3 × green ON indicating 120V AC (8034) 1 × red Reverse Polarity 120V AC (8066)	3 × green ON indicating 120V AC (8034) 1 × red Reverse Polarity 120V AC (8066)	2 × green ON indicating 240V AC (6806)
Labels Included	1 × AC Main, 1 Reverse Polarity 1 × ELCI, 30 Basic AC (4206) Panel Voltage ID	1 × AC Main, 1 Reverse Polarity 1 × ELCI, 30 Basic AC (4206) Panel Voltage ID	1 × AC Main, 1 Reverse Polarity 1 × ELCI, 30 Basic AC (4206) Panel Voltage ID	1 × AC Main, 1 ELCI Panel Voltage ID



Part #	3122	3128	3130
Description	ELCI Main + 2 branch positions	ELCI Main + 3 branch positions	UL 489 AC Main + 4 branch positions
Circuit Breakers Installed	1 x ELCI Main 230V, 16A, 30mA (3091) 2 x Branch, 8A (7401)	1 x ELCI Main 120V, 30A, 30mA (3102) 3 x Branch, 15A (7403)	1 x Main 120V, 50A (7467) 3 x Branch, 15A (7456)
Glands Included	2 x (3124) 3 x (3125)	2 x (3124) 3 x (3125)	2 x (3124) 3 x (3125)
LEDs Installed	3 x green ON indicating 230V AC (8134) 1 x red Reverse Polarity 230V AC (8166)	4 x green ON indicating 230V AC (8134) 1 x red Reverse Polarity 230V AC (8166)	5 x green ON indicating 120V AC (8034) 1 x red Reverse Polarity 120V AC (8066)
Labels Included	1 x AC Main, 1 Reverse Polarity 1 x ELCI, 30 Basic AC (4206) Panel Voltage ID	1 x AC Main, 1 Reverse Polarity 1 x ELCI, 30 Basic AC (4206) Panel Voltage ID	1 x AC Main, 1 Reverse Polarity 1 x 30 Basic AC (4206) Panel Voltage ID



Part #	3133	3134	3135
Total Positions	DC Main + 5 branch positions	DC 6 branch positions	UL 489 DC Main + 5 branch positions
Circuit Breakers Installed	1 x Main 12/24V DC, 100A (7549) 3 x Branch 12/24V DC, 15A (7403)	4 x Branch 12/24V DC, 15A (7403)	1 x Main 12/24V DC, 100A (7446) 3 x Branch 12/24V DC, 15A (7442)
Glands Included	2 x (3124) 2 x (3125) 1 x (3126)	2 x (3124) 2 x (3125) 1 x (3126)	2 x (3124) 2 x (3125) 1 x (3126)
LEDs Installed	6 x amber ON indicating 12/24V DC (8033)	6 x amber ON indicating 12/24V DC (8033)	6 x amber ON indicating 12/24V DC (8033)
Labels Included	1 x DC Main 30 Basic DC (4218) Panel Voltage ID 12V and 24V DC	30 Basic DC (4218) Panel Voltage ID 12V and 24V DC	30 Basic DC (4218) Panel Voltage ID 12V and 24V DC

SMS Surface Mount System Panel Enclosure Glands

Used on the SMS Surface Mount System Panel Enclosures



Part #	3124	3125	3126
Description	Small Gland PG7	Medium Gland PG16	Large Gland PG29
Wire Size	#14 to #10 Single Wire	#14 to #10 Cable, 3 Conductor	#6 Cable, 4 Conductor
Cable Dia. Minimum	.114 in (2.9 mm)	.230 in (2.9 mm)	.590 in (15.0 mm)
Cable Dia. Maximum	.250 in (6.4 mm)	.530 in (2.9 mm)	.990 in (25.4 mm)
Dimensions in (mm)	A. Clearance Hole .492 (12.5) B. Max. O. A. Length 1.17 (29.7) C. Wrenching Flats .59 (15.0)	A. Clearance Hole .886 (22.5) B. Max. O. A. Length 1.66 (42.2) C. Wrenching Flats 1.05 in (26.7)	A. Clearance Hole 1.47 (37.3) B. Max. O. A. Length 2.23 (56.6) C. Wrenching Flats 1.66 (42.2)

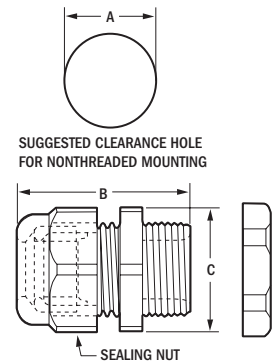

Related Products

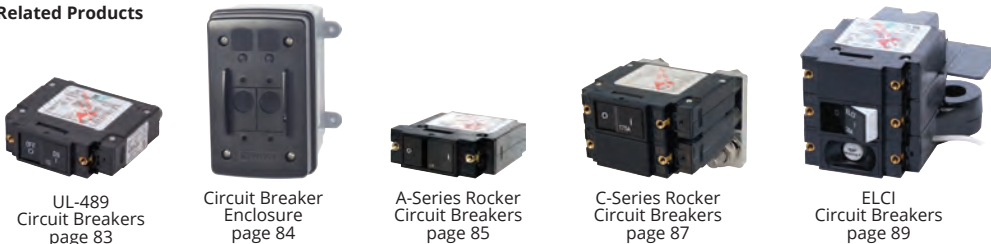

UL-489
Circuit Breakers
page 83

Circuit Breaker
Enclosure
page 84







A-Series Rocker
Circuit Breakers
page 85

C-Series Rocker
Circuit Breakers
page 87

ELCI
Circuit Breakers
page 89

Circuit Breaker Specification Table

DC Thermal Circuit Breakers

Product	Push Button Reset-Only	Medium Duty Push Button Reset-Only*	Short Stop	ATO/ATC-Style Low Profile	285-Series	187-Series
	AC/DC					
						
Page number	77	78	78	79	80	81
Interrupting Capacity	3,000A @ 14.7V DC 2,500A @ 28V DC	5,000A @ 32V DC 3,000A @ 120V AC*	2,500A @ 28V DC	2,000A @ 28V DC	3,000A @ 48V DC†	5,000A @ 12V DC 3,000A @ 24V DC 1,500A @ 42V DC
Max. Voltage	32V DC	32V DC / 120V AC*	28V DC	32V DC	48V DC	48V DC
Amperages	3-40A	15-60A	5-50A	5-30A	25-150A	25-200A
Regulatory	CE marked, UL 1077, TUV certified, UL 1500, ISO 8846	SAE J1428, SAE J553, UL 1077, UL 1500	SAE J553, SAE J1171, IP64	SAE J553, SAE J1171	CE marked, SAE J1171, IP67	CE marked, SAE J1171, IP66







* Medium Duty Push Button Reset-Only Circuit Breakers are AC/DC rated

† AIC ratings achieved using SAE J1625

AC/DC A-Series Circuit Breakers

Product	A-Series Toggle	A-Series Flat Rocker	A-Series Restricted Off Rocker	A-Series Toggle	A-Series Flat Rocker	A-Series Raised Rocker
						
Page number	84	85	85	84	85	85
Interrupting Capacity DC	7,500A @ 65V DC	5,000A @ 32V DC		7,500A @ 65V DC	5,000A @ 32V DC	
Interrupting Capacity AC	3,000A @ 120V AC 3,000A @ 250V AC	3,000A @ 125V AC 1,500A @ 250V AC		3,000A @ 120V AC 3,000A @ 120/240V AC 3,000A @ 250V AC	3,000A @ 240V AC	
Max. Voltage DC	65V DC	32V DC		65V DC	32V DC	
Max. Voltage AC		250V AC			240V AC	
Poles		1			2	
Amperages	2.5-50A	2.5-50A	5-50A		10-50A	
Regulatory	CE marked, TUV certified, CSA certified, UL 1077					







AC/DC Military Grade and C-Series Circuit Breakers

Product Style	COTS Water Resistant	AC UL-489 Rocker	DC UL-489 Rocker	C-Series Toggle	C-Series Toggle	C-Series Flat Rocker
						
Page number	82	83	83	86	86	87
Interrupting Capacity DC	7500A	-	10,000A	10,000A @ 80V DC	10,000A @ 80V DC	5,000A @ 32V DC
Interrupting Capacity AC	1500A	5000A	-	5,000A @ 125V AC 5,000A @ 250V AC	5,000A @ 125V AC 5,000A @ 250V AC	3,000A @ 120V AC 3,500A @ 240V AC
Max. Voltage DC	65V DC	-		80V DC		32V DC
Max. Voltage AC	-	240V AC	-	250V AC		240V AC
Poles	2	1 & 2		1		
Amperages	5-50A	5-50A	5-100A	5-100A	100A	5-100A
Regulatory	UL 1077, CSA certified	UL 489, CSA certified TUV certified		--	SAE J1171, UL 1500, ISO 8846	CE marked, SAE J1171, UL 1500, ISO 8846, CSA certified, UL 1077





DC C-Series Circuit Breakers

Product Style	C-Series Toggle	C-Series Flat Rocker	C-Series Toggle	C-Series Flat Rocker
				
Page number	86	87	86	87
Interrupting Capacity	5,000A @ 65V DC	5,000A @ 48V DC	5,000A @ 65V DC	5,000A @ 48V DC
Max. Voltage	65V DC	48V DC	65V DC	48V DC
Poles	2		3	
Amperages	150-200A		250-300A	
Regulatory	--	--	--	--

AC C-Series Circuit Breakers

Product Style	C-Series Toggle	C-Series Raised Rocker	C-Series Flat Rocker	C-Series Toggle	C-Series Raised Rocker	C-Series Flat Rocker
						
Page number	86	87	87	86	87	87
Interrupting Capacity	5,000A @ 125/250V AC 5,000A @ 250V AC	5,000A @ 120/240V AC 5,000A @ 240V AC		5,000A @ 125/250V AC 5,000A @ 250V AC	5,000A @ 120/240V AC 5,000A @ 240V AC	
Max. Voltage	250V AC	240V AC		250V AC	240V AC	
Poles	2			3		
Amperages	30-100A			50-100A		
Regulatory	--	CE marked, TUV certified, CSA certified, UL 1077		--	CE marked, TUV certified, CSA certified, UL 1077	

AC ELCI Main Circuit Breakers

Product	ELCI Main	ELCI Main	ELCI Main	ELCI Main	ELCI Main		
							
Page number	89	89	89	89	3091* (89)	3092* (89)	3093† (89)
Interrupting Capacity	5000A						
Nominal Voltage				120/240V per pole	230V per pole		240V per pole
Amperage	30A		50A	50A	16A	32A	50A
Leakage Trip Amps	30mA			30mA	30mA		
Regulatory	UL 1077, UL 943 Class A, UL 1500						

* 230V AC, Typical of Europe
 † 240V AC, For isolation transformer applications

Water-Resistant Contura Switches

Specifically manufactured for use in Blue Sea Systems Contura Water Resistant Panels



Use of non Blue Sea Systems Contura Switches will not maintain the water resistant ingress protection rating of Blue Sea Systems panels.

- Vibration, shock, thermoshock, moisture and salt spray resistant
- Mounts in Blue Sea Systems Contura Water Resistant Panels (p. 116) and Contura Switch Mounting Panels (p. 96)

Amperage Max. Operating	20A @ 12V DC, 15A @ 24V DC
Amperage Operating Current	18 Milliamps
Lighted	LED rated 100,000 hours half-life
Seals	Internal and external gasket panel seal
Temperature Rating	-40°C (-40°F) to 85°C (185°F)
Mounting Hole	1.45 in x 0.83 in (36.83 mm x 21.08 mm)
Regulatory	
CE marked	
Meets UL 1500 and ISO 8846 external ignition protection requirements	

IGNITION PROTECTED

Part # Contura II Black	Part # Contura III Gray	Part # Contura III Black	Actuator Position to Light LED	Pole Throw	Action ()=momentary	LEDs
7929	8230	8282	ON	SPST	OFF-ON	1
7930	8231	8292	--	SPST	OFF-(ON)	0
7931	8232	8283	ON	SPDT	ON-OFF-ON	2
7932	8233	8284	ON	SPDT	(ON)-OFF-ON	1
7933	8234	8285	--	SPDT	(ON)-OFF-(ON)	0
7943	7944	7945	(ON)	SPDT	(ON)-OFF-ON	1
7934	8218	8287	ON	DPST	OFF-ON	1
7935	8219	8288	--	DPST	OFF-(ON)	0
7936	8220	8286	ON	DPDT	ON-OFF-ON	2
7937	8221	8289	ON	DPDT	(ON)-OFF-ON	1
7938	8222	8290	--	DPDT	(ON)-OFF-(ON)	0
7939	8275	8300	ON	DPDT	ON-ON	2

See p. 93 for common applications

Related Products

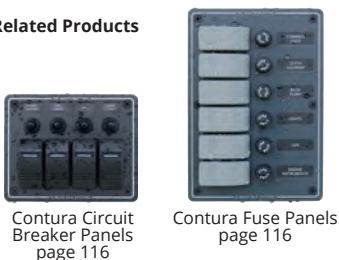

Contura Circuit Breaker Panels page 116

Contura Fuse Panels page 116

Water-Resistant Contura Dimmer and m-LVD Switches



- Mounts in Blue Sea Systems Contura Water-Resistant Panels (p. 116) and Contura Switch Mounting Panels (p. 96)
- Dimmer Switch Legend - BRIGHT and DIM
- m-LVD Switch Legend-OVERRIDE and OFF
- Ignition protected - safe for installation aboard gasoline powered boats

Amperage Max. Operating	20A @ 12V DC, 15A @ 24V DC
Pole, Throw	SPDT
Action	(ON)-OFF-(ON)
Terminal Size	0.25 in (6.35 mm)
Terminal Type	Quick Connect Tab
Seals	Internal and external gasket panel seal
Temperature Rating	-40°C (-40°F) to 85°C (185°F)
Mounting Hole	1.45 in x 0.83 in (36.83 mm x 21.08 mm)
Regulatory CE marked	

Part #	For Use With:	LEDs
8216	DeckHand Dimmer (p. 23)	--
8291	DeckHand Dimmer (p. 23)	--
7928	m-LVD Low Voltage Disconnect (p. 36)	1

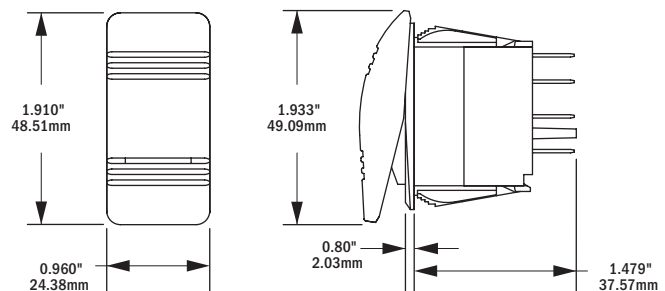

Related Products



DeckHand Dimmers page 29

m-LVD page 42

Remote Control Contura Switches

Provide remote switching of ML-Series Products



2145, 2155

2146

- Vibration, shock, thermoshock, moisture and salt spray resistant
- Lockout slide reduces the risk of accidental switching 2145 and 2155

Amperage Max. Operating	20A @ 12V DC, 15A @ 24V DC
Amperage Operating Current	18mA
Temperature Range	-40°C (-40°F) to 85°C (185°F)
Pole/Throw	SPDT
Lighting	LED rated 100,000 hours half-life
Seals	Internal and external gasket panel seal
Mounting Hole	1.45" x 0.83" (36.83 mm x 21.08 mm)
Regulatory Meets UL 1500 and ISO 8846 external ignition protection requirements IP67 – protected against immersion up to 1 meter for 30 minutes (see inside back cover)	

**IGNITION
PROTECTED**

Part #	For Use With:	Pole Throw	Action ()=momentary
2145	ML-Series 7700, 7701, 7702, 7703 (p. 39)	SPDT	(ON)-OFF-(ON)
2146	ML-Series 7620, 7622, 7621, 7623 (p. 47)	SPDT	ON-OFF-ON
2155	ML-Series 7713, 7717 (p. 39)	SPDT	ON-ON

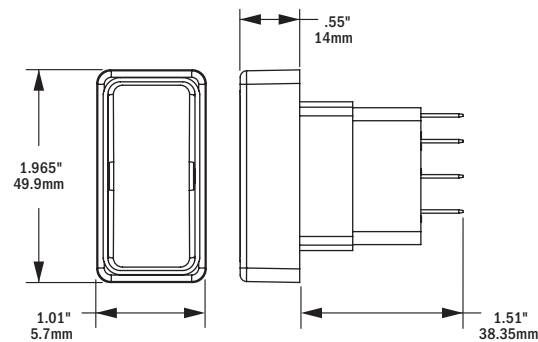

Related Products



ML-Series RBS page 45

ML-Series ACR page 53

Contura Switch Mounting Panel Plug

Covers Contura Switch mounting hole for future switch installation



- For use with Contura Switch Mounting Panels

Part #	Description
8278	Contura Switch Mounting Panel Plug

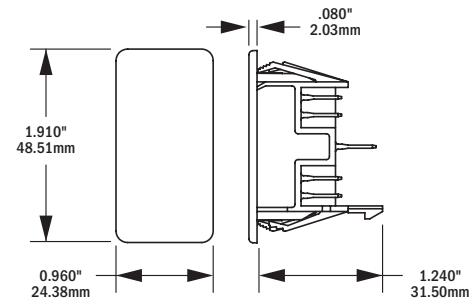

Related Products



Contura Switch Mounting Panels page 96

Contura Switch Actuators

Replaces actuators on Blue Sea Systems Contura Water-Resistant Panels



8297

8294

8293

- Mounts on any Blue Sea Systems Water Resistant Contura Switch

Part # Gray	Part # Black	Lenses
8299	8296	--
8297	8294	1
8298	8295	2
8293	Actuator Removal Tool	

Remote Control Switch 360 Panels

Use with ML-Series Remote Battery Switches or Automatic Charging Relays

- Backlit labels
- Lockout slides
- Square format label set 4218 (p. 156)



1147 Switches: 2145 (2); 2146 (1)



1148 Switches: 2145 (3)

Part #	Description	Max. Volts	Width in (mm)	Height in (mm)	Depth in (mm)
1147	2 RBS and 1 ACR	24V DC	4.88 (123.83)	4.75 (120.65)	2.00 (50.80)
1148	3 RBS	24V DC	4.88 (123.83)	4.75 (120.65)	2.00 (50.80)
1520	3 Blank Apertures	—	4.88 (123.83)	4.75 (120.65)	0.125 (3.175)

Contura Switch Mounting Panels

Modular design permits assembly in groups



8267

8266

8268

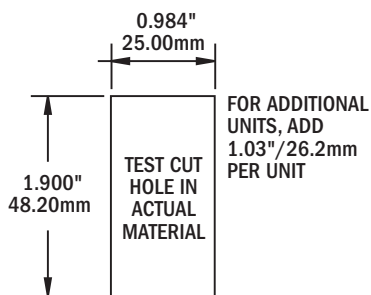

Cutout Dimensions

- Mounting panels available in 1, 3, and 6 fixed position models
- Designed for mounting in 6 different panel thicknesses:
 - 0.06 in (1.57 mm) 0.09 in (2.36 mm) 0.13 in (3.17 mm)
 - 0.19 in (4.75 mm) 0.25 in (6.35 mm) 0.38 in (9.52 mm)

Part #	Description	Width in (mm)	Height in (mm)
8267	End Mounting Panel	1.19 (30.23)	2.30 (58.42)
8266	Center Mounting Panel	1.03 (26.16)	2.30 (58.42)
8268	1 Position Mounting Panel	1.34 (34.04)	2.30 (58.42)
8259	3 Position Mounting Panel	3.40 (86.36)	2.30 (58.42)
8260	6 Position Mounting Panel	6.49 (164.85)	2.30 (58.42)

Dual Bilge Pump 360 Panel

Controls two bilge pumps with restricted-off circuit breakers and manual override switches

- Controls two bilge pumps
- Restricted-OFF circuit breakers provide 24-hour circuit protection to the bilge pump float switch
- On-indicating LED indicates power is available at the bilge pump float switch
- Manual override switch with on-indicating LED provides visual indication pump is running; also illuminates when pump is running as a result of float switch operation



Part #	Description	Width in (mm)	Height in (mm)
1522	Dual Bilge Pump Control Panel	4.88 (123.83)	4.75 (120.65)

360 Panel Rocker Switches

Provides switching options for different configurations

Amperage Max. Operating	See table below
Single Pole Connections	0.187 in (4.80 mm) Quick Connect Tabs
Double Pole Connections	6.00 in (152.00 mm) Wire Leads

Part #	Pole-Throw	Poles	Image	Action Momentary () =	Amps Max. Operating			
					12V DC	24V DC	125V AC	250V AC
7480	SPST	Single	1	OFF-ON	10A	10A	10A	10A
7481	SPST	Single	1	OFF-(ON)	10A	10A	12A	6A
7482	SPDT	Single	2	ON-OFF-ON	10A	8A	8A	8A
7483	SPDT	Single	2	(ON)-OFF-ON	10A	8A	8A	8A
7484	SPDT	Single	2	(ON)-OFF-(ON)	10A	8A	8A	8A
7485	SPDT	Single	4	(ON)-OFF-(ON)	10A	8A	8A	8A
7490	DPST	Double	1	OFF-ON	5A	5A	8A	4A
7491	DPDT	Double	3	ON-ON	5A	5A	8A	4A
7492	DPDT	Double	2	ON-OFF-ON	5A	5A	8A	4A
7493	DPDT	Double	3	ON-(ON)	5A	5A	8A	4A
7494	DPDT	Double	2	(ON)-OFF-ON	5A	5A	8A	4A
7495	DPDT	Double	2	(ON)-OFF-(ON)	5A	5A	8A	4A



Recommended Panel Opening

PANEL THICKNESS	A	B	+.000 [.00] -.004 [.10] ← B → ↑ A ↓ TEST CUT HOLE IN ACTUAL MATERIAL
.030" (.76mm)-.050" (1.27mm)	.508" (12.90mm)	.756" (19.20mm)	
.050" (1.27mm)-.078" (1.98mm)	.508" (12.90mm)	.764" (19.40mm)	
.078" (1.98mm)-.125" (3.17mm)	.508" (12.90mm)	.780" (19.81mm)	

Push Button Switches

Contemporary and compact 10A, 15A, & 20A switching

- Two push button illumination options to choose from - backlit and LED ring
- 316 Stainless Steel for optimal appearance and corrosion resistance
- IP67 waterproof with O-ring panel gasket and molded rear cover
- Reverse polarity protected

	4160, 4161, 4162, 4163	4180 & 4181	4190 & 4192
Amperage Max. Operating	10A @ 12V DC	15A @ 12V DC	20A @ 12V DC
Voltage Nominal	12V DC	12V DC	12V DC
Max. LED Operating Current	20mA	20mA	20mA
Switching Cycles	40,000	10,000	60,000
Temperature Range	-10°C to 70°C 14°F to 158°F	-20°C to 55°C -4°F to 131°F	-30°C to 85°C -22°F to 185°F
Termination	5 - 0.110" Quick Connect tabs terminals included	3" Bare Pigtails	6" Bare Pigtails 0.187" Quick Connect tabs
Wire Size	--	8-16 AWG	14 AWG
Panel Thickness	.04" -.31" (1-8mm)	.04" -.24" (1-6mm)	.04" -.24" (1-6mm)
Mounting Hole Diameter	3/4" (19mm)	7/8" (22.35mm)	3/4" (19mm)
Regulatory IP67 - protected against immersion up to 1 meter for 30 minutes (see inside back cover)			

Push Button Switch Label Kit

ICON Labels used on Backlit Push Button Switches

- Scratch resistant polycarbonate material
- Back printed for durability
- Waterproof adhesive for longevity in wet environments
- Can be ordered individually (p. 156)

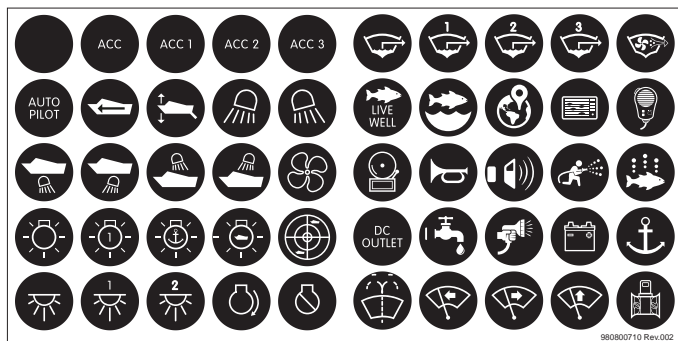

Part #	Description	Quantity
4230	Icon Label Kit	50 labels

Related Products



Individual Round Icon Labels page 156

10A LED Ring Push Button Switches



Part #	LED	Action
4160	Blue	OFF-ON
4161	Blue	OFF-(ON)
4162	Red	OFF-ON
4163	Red	OFF-(ON)

15A Backlit Push Button Switches

- Backlit button is blue when OFF and red when ON
- Five ICON labels included: Accessory, Lights, Anchor Light, Running Light, and Bilge Pump
- Additional 50 ICON label kit sold separately



Part #	LED	Action
4180	Blue / Red	OFF-ON
4181	Blue / Red	OFF-(ON)

() = Momentary

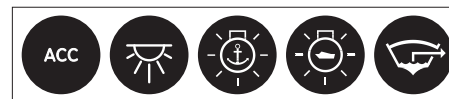

5 ICON labels included

20A LED Ring Push Button Switches

- Red or Blue LED ON indication ring



Part #	LED	Action
4190	Blue	OFF-ON
4192	Red	OFF-ON

WeatherDeck® Toggle Switches

For use in WeatherDeck Waterproof Panels



4150-4154

4155

- Manufactured for use in WeatherDeck Waterproof Panels (p. 117)
- Nickel-plated brass and phenolic non-corrosive construction

	4150-4154	4155
Amperage Max. Operating	10A @ 250V AC 15A @ 125V AC 15A @ 12V DC	5A @ 30V DC
Voltage Max. Operating	250V AC	30V DC
Terminal Size	0.25 in (6.35 mm)	0.25 in (6.35 mm)
Terminal Type	Quick Connect Tab	Quick Connect Tab

Part #	Pole/Throw	Action () = Momentary
4150	SPST	OFF-ON
4151	SPST	OFF-(ON)
4152	SPDT	ON-OFF-ON
4153	SPDT	(ON)-OFF-(ON)
4154	SPDT	(ON)-OFF-(ON)
4155	DPDT	ON-OFF-ON

WeatherDeck® Toggle Switch Boot

Replaces boot on WeatherDeck Waterproof Panels



- For mounting on WeatherDeck Toggle Switches above
- UV resistant material resists discoloration and cracking
- Rated IP67 – protected against immersion up to 1 meter for 30 minutes (See inside back cover)

Thread Material	Nickel Plated Brass
Thread	15/32"-32UNS-2A

Part #	Description
4138	WeatherDeck Toggle Switch Boot

Related Products



WeatherDeck Panels
page 117

Panel Switches

Mounts in an A-Series toggle circuit breaker aperture to provide multiple throw and switch configurations when circuit protection is provided elsewhere



8204

8200

- Ideal for generator starters, bilge pumps, horns, wipers, engine controls and other applications that require switching action other than ON-OFF or different pole configuration separate from circuit protection
- For use with A-Series Toggle Circuit Breaker Mounting Panel (p. 84)
- Supplied with mounting adapter for standard 5/8" circuit breaker mounting hole
- Nickel-plated brass and phenolic non-corrosive construction

	Toggle	Push Button
Amperage Max. Operating	10A @ 250V AC 15A @ 125V AC 15A @ 32V DC	3A @ 250V AC 6A @ 125V AC 6A @ 32V DC
Terminal Size	0.25 in (6.35 mm)	0.25 in (6.35 mm)
Terminal Type	Quick Connect Tab	Quick Connect Tab
Actuator Color	White	White

Part #	Actuator	Pole/Throw	Action () = Momentary
8200	Push Button	SPST	OFF-(ON)
8204	Toggle	SPST	OFF-ON
8205	Toggle	SPST	OFF-(ON)
8206	Toggle	SPDT	ON-OFF-ON
8207	Toggle	SPDT	(ON)-OFF-(ON)
8208	Toggle	SPDT	(ON)-OFF-(ON)
8209	Toggle	DPST*	OFF-ON-(ON) / OFF-OFF-(ON)
8210	Toggle	DPST	OFF-ON
8211	Toggle	DPDT	ON-OFF-ON
8212	Toggle	DPDT	(ON)-OFF-(ON)

* Progressive two circuit switch - maintains Circuit 1 while momentarily switching Circuit 2

360 Panel Adapters and Plugs

Adapters allow mounting alternative switches and circuit breakers in the flat rocker aperture. Plugs fill empty flat rocker apertures.



4111

4112

4119

4116

4117

Part #	Description
4111	Adapts Push Button Reset-Only Circuit Breaker (p. 77)
4112	Adapts A-Series Toggle Circuit Breaker (p. 84) and Panel Switch
4119	Adapts 360 Panel Rocker Switch (p. 96)
4116	Panel Plug fills flat rocker circuit breaker aperture
4117	Panel Plug fills 360 Panel Rocker Switch aperture
8037	Panel Plugs fill Toggle Circuit Breaker aperture (6 pack)

Switch Comparison

SPST Turns a single circuit on and off.
SPDT Turns one of two circuits on.
DPST Turns two circuits on at the same time.
DPDT Turns one circuit in each of 2 pairs of circuits.



Switch Type	Action	Common Applications	Contura II Black p. 94	Contura III Gray p. 94	Contura III Black p. 94	Contura ML Control p. 95	360 Panel Rockers p. 96	LED Ring Push-Button p. 97	Backlit Push-Button p. 97	WeatherDeck® Toggle p. 98	Panel Switch p. 98	Panel Switch p. 98
SPST	OFF-ON	Lights	7929	8230	8282	-	7480	4160 4162 4190 4192	4180	4150	--	8204
SPST	OFF-(ON)	Horn or Windshield wipers	7930	8231	8292	-	7481	4161 4163	4181	4151	8200	8205
SPDT	ON-OFF-ON	Combining nav lights or anchor light with independent bulbs	7931	8232	8283	2146	7482	--	--	4152	--	8206
SPDT	(ON)-OFF-ON	Windshield wipers LED - ON	7932	8233	8284	--	7483	--	--	4153	--	8207
		Bilge pumps LED - (ON)	7943	7944	7945	--	--	--	--	--	--	--
SPDT	ON-ON	Control switch for SafetyHub 250 and ML-Series RBS 7712 and 7714	--	--	--	2155	--	--	--	--	--	--
SPDT	(ON)-OFF-(ON)	Intermittent wiper, Trim tabs, Control switch for ML-Series RBS except 7712 and 7714	7933	8234	8285	2145	7484 7485	--	--	4154	--	8208
DPST	OFF-ON	Navigational lights	7934	8218	8287	--	7490	--	--	--	--	8210
DPST	OFF-(ON)	Wipers or horn	7935	8219	8288	--	--	--	--	--	--	--
DPST	OFF-ON-(ON) OFF-OFF-(ON)	Combining nav lights and anchor lights with shared switch	--	--	--	--	--	--	--	--	--	8209
DPDT	ON-OFF-ON	Combining nav lights with anchor light with shared bulb	7936	8220	8286	--	7492	--	--	4155	--	8211
DPDT	(ON)-OFF-ON	Dual wipers	7937	8221	8289	--	7494	--	--	--	--	8212
DPDT	(ON)-OFF-(ON)	Power operated hatches	7938	8222	8290	--	7495	--	--	--	--	--
DPDT	ON-(ON)	Bilge pump with 2 circuits	--	--	--	--	7493	--	--	--	--	--
DPDT	ON-ON	Switching between shunts or current transformers with one meter	7939	8275	8300	--	7491	--	--	--	--	--

() = Momentary ● Center Terminal Switch Lever ● Terminal ○ Off Position

CONNECTORS & INSULATORS

Water-Resistant 100A BusBar

102



Provides secure water-resistant bussing for harsh environments. The single side nesting design allows for wire entry from one side to maximize space.

Common BusBars

102



BusBars distribute positive wires or collect negative returns. BusBars range in capacity from 100A to 600A, with a variety of terminal stud configurations.

Terminal Blocks

105



Terminal blocks allow termination of wires from a multi-conductor cable in one location. Individual wires can then be split off to various loads.

PowerBars

106

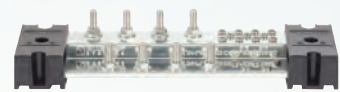

Complex wiring systems require a single point to consolidate large and small conductors.



CONNECTORS & INSULATORS

PowerPost Connectors



Insulated single stainless steel stud terminates multiple large conductors, or collects small wires with tin-plated copper bus.

Feed Through Connectors



Eliminates chafe and provides strain relief when passing high current through hulls, decks, and bulkheads.

CableCaps



Provides insulation for multiple types of battery posts.

CableClams



Provides a waterproof pass-through for antenna cables without requiring removal of the factory installed connector.



Connectors and BusBars are the backbone of every electrical system and safely keep current flowing.

Blue Sea Systems' connectors and busbars reduce heat and improve efficiency and reliability in a boat or vehicle's electrical system.

Water-Resistant - 100A BusBar **NEW**

Provides secure water-resistant bussing for harsh environments. The single side nesting design allows for wire entry from one side to maximize space.

- Water-resistant IP66 design
- Accepts standard ring or fork type terminals to allow for simple wiring with standard tools.
- Accepts a wide range of wire sizes
- Integral plugs maintain water-resistant rating if less than four loads are required
- Nests with Water-Resistant 100A Common BusBar (2356 or 2356100) and ST-Blade Water-Resistant Fuse Block (5056 or 5056100)
- Ideal for positive distribution or for the collection of DC negative or AC grounding conductors
- Tin-plated copper busses and fuse clips
- Includes four write-on circuit labels
- Small format standard and custom labels available

Continuous Rating	100A AC / 100A DC
Voltage Max. Operating	300V AC / 48V DC
Input Wire Size	(1) 8 AWG to 4 AWG
Load Wire Size	(4) 16 AWG to 10 AWG
Mounting Holes	Accepts 1/4" (6mm) Screws
Bus Material	Tin-Plated Copper C11000

Regulatory For an ABYC/USCG compliant design use (2356100) CE marked, IP66 - protected against powerful water jets (see inside back cover)

Part #	Cover	Terminal Screws	Terminal Studs
2356	Screw Cover	4 × #8-32	1 × #10-32
2356100	Manual Cover	4 × #8-32	1 × #10-32

For the dimensioned drawings see page 64



2356100

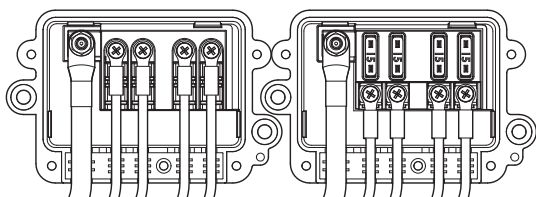

Nested ST-Blade Water-Resistant Fuse Block 5056 and Water-Resistant - 100A BusBar 2356

Related Products



ST-Blade Water-Resistant Fuse Block page 64

MiniBus - 100A Common BusBars

Provides bussing for limited space applications

- One-piece serrated flange nut ensures correct and secure connections

Continuous Rating	100A AC / 100A DC
Voltage Max. Operating	300V AC / 48V DC
Mounting Holes	Accepts #10 (M5) Screws
Bus Material	Tin-Plated Copper C11000
Regulatory CE certified	

Part #	Cover	Terminal Screws	Terminal Studs
2304	--	5 × #8-32	2 × #10-32
2314	Yes	5 × #8-32	2 × #10-32
2305	--	--	4 × #10-32
2315	Yes	--	4 × #10-32
2306	--	6 × #8-32	--
2713	Cover For MiniBus 2304 and 2305		

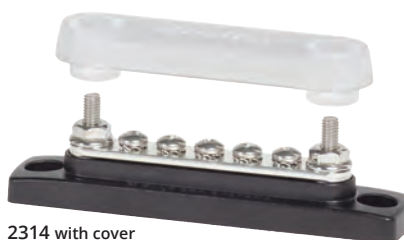

2314 with cover
2304 without cover



2315 with cover
2305 without cover



2306 is DC only rated.
Mounting holes accept #8 screws

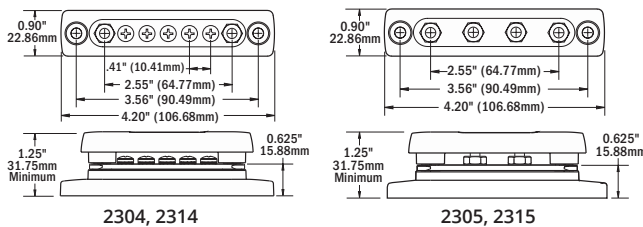

2304, 2314

2305, 2315

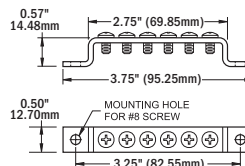

2306

DualBus - 100A Common BusBars

Combines two buses on one block

- Combines negative and positive buses for DC Systems and neutral and ground buses for AC Systems

Continuous Rating	100A AC / 100A DC
Voltage Max. Operating	300V AC / 48V DC
Bus Material	Tin-Plated Copper C11000
Regulatory CE certified	

Part #	Cover	Terminal Screws	Mounting Holes
2701	--	5 per bus × #8-32	Accept #10 (M5) Screws
2702	--	10 per bus × #8-32	Accept #10 (M5) Screws
2709	Cover for 2701		
2710	Cover for 2702		

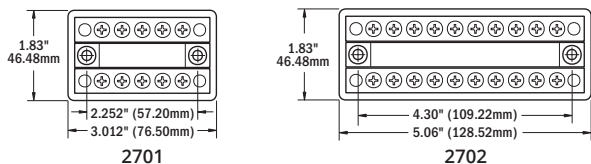

DualBus Plus - 150A Common BusBars

Secure, clear polycarbonate cover snaps on easily to meet ABYC insulation requirements

- Combines negative and positive buses on one block
- Cover release buttons
- One-piece stainless flange nuts ensure safe and secure connections

Continuous Rating	130A AC / 150A DC
Voltage Max. Operating	300V AC / 48V DC
Mounting Holes	Accept #10 (M5) Screws
Bus Material	Tin-Plated Copper C11000

Part #	Terminal Screws	Terminal Studs
2722	5 per bus × #10-32	2 per bus × 1/4"-20 Stud
2723	5 per bus × #10-32	2 per bus × 5/16"-18 Stud



2722

150A Common BusBars

Insert-molded stainless steel studs eliminate the need for securing nuts and allow high torquing for excellent electrical contact

- For positive distribution and for the collection of negative or AC ground circuits
- One-piece serrated flange nut ensures correct and secure connections

Continuous Rating	130A AC / 150A DC
Voltage Max. Operating	300V AC / 48V DC
Mounting Holes	Accepts #10 (M5) Screws
Bus Material	Tin-Plated Copper C11000
Regulatory CE certified	

Part #	Cover	Terminal Screw	Terminal Stud
2301	--	10 × #8-32	2 × 1/4"-20
2300	Yes	10 × #8-32	2 × 1/4"-20
2302	--	20 × #8-32	2 × 1/4"-20
2312	Yes	20 × #8-32	2 × 1/4"-20
2303	--	--	4 × 1/4"-20
2307	Yes	--	4 × 1/4"-20
2715	Cover 2301 and 2303		
2716	Cover for 2302		

Note: 2715 replaces 2706, 2716 replaces 2707



2300 with cover
2301 without cover



2307 with cover
2303 without cover



2312 with cover
2302 without cover

MaxiBus -250A Common BusBars

Now with insert-molded stainless steel studs and optional fully enclosed insulating base and cover

- Insulating cover with breakouts for easy wire access
- Insulating cover meets ABYC insulation requirements
- One-piece serrated flange nuts ensure correct and secure connections

Continuous Rating	250A AC / 250A DC
Voltage Max. Operating	300V AC / 48V DC
Mounting Hardware	#10 (M5) Screws
Bus Material	Tin-Plated Copper C11000
Regulatory	CE certified



2128



2105



2127



2126

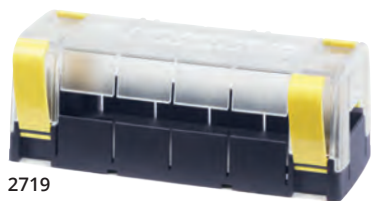

2719



2718

2719 Related Products



285 Series Circuit Breakers 7180-7189 page 80



DC Shunts page 151

2718 Related Product



PowerBar 600A Common BusBar 2104 page 106

Part #	Terminal Studs	Terminal Screws	[A] Length in (mm)	[B] Mounting Centers in (mm)
2105	2 × 5/16" -18	12 × #10-24	7.75 (197.00)	7.125 (181.00)
2126	6 × 5/16" -18	-	7.75 (197.00)	7.125 (181.00)
2718	Cover for 2105 and 2126		8.78 (223.10)	5.41 (137.30)
2127	4 × 5/16" -18	-	5.875 (149.00)	5.25 (133.00)
2128	2 × 5/16" -18	6 × #10-24	5.875 (149.00)	5.25 (133.00)
2719	Cover for 2127 and 2128		6.70 (170.00)	4.10 (104.10)

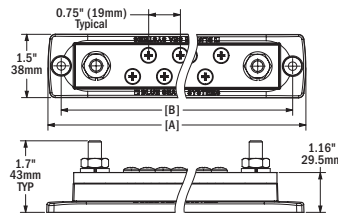

2128, 2105

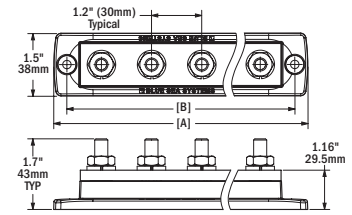

2127, 2126

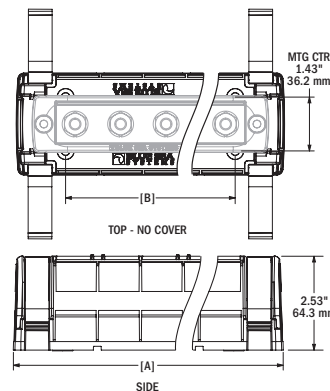

2719 and 2718

PowerBar Common BusBars

Provides compact high-amp busing with 3/8" terminal studs



2019

Continuous Rating	up to 200A
Voltage Max. Operating	48V DC
Mounting Holes	Accepts #10 (M5) Screws
Bus Material	Tin-Plated Copper C11000
Regulatory	CE certified

Part #	Terminal Studs	Insulators
2019	2 × 3/8" -16	Yes
2020	2 × 3/8" -16	--

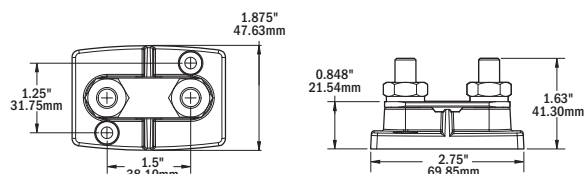

Terminal Blocks

Fully insulated independent terminal blocks to isolate circuits

- Each screw pair is one isolated circuit
- Terminal Block Jumpers allow creation of common circuits
- Closed back design insulates power from the mounting surface

Bus Material	Nickel-Plated Brass
Base Material	High temp UL 94 VO thermoplastics
Regulatory	RoHS and UL Recognized, CE certified



2406

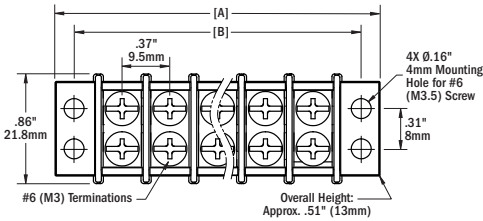

2402-2410



2506

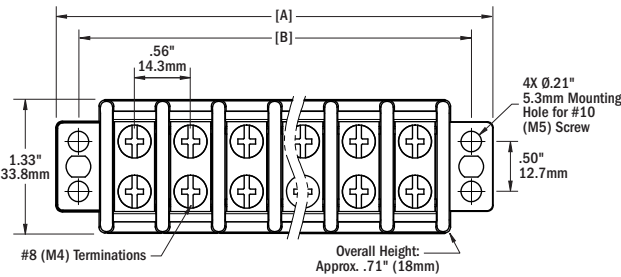

2502-2512



2606

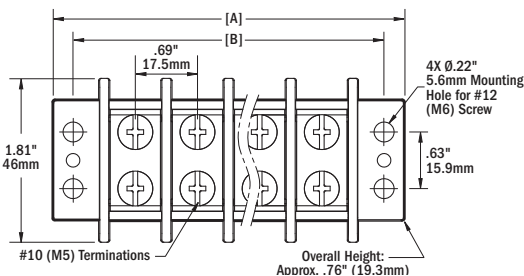

2602-2610

Part #	Circuits	AC/DC Amps	AC/DC Volts	Terminal Screw	[A] Length in (mm)	[B] Mounting Centers in (mm)
2402	2	20A	300V	M3.5 (#6)	1.43 (36.20)	1.13 (28.70)
2404	4	20A	300V	M3.5 (#6)	2.17 (55.00)	1.87 (47.60)
2406	6	20A	300V	M3.5 (#6)	2.91 (74.00)	2.62 (66.60)
2408	8	20A	300V	M3.5 (#6)	3.66 (93.00)	3.37 (85.60)
2410	10	20A	300V	M3.5 (#6)	4.41 (112.00)	4.12 (104.60)
2502	2	30A	600V	M4 (#8)	2.13 (54.00)	1.69 (42.80)
2504	4	30A	600V	M4 (#8)	3.25 (82.60)	2.81 (71.40)
2506	6	30A	600V	M4 (#8)	4.38 (111.20)	3.94 (100.00)
2508	8	30A	600V	M4 (#8)	5.50 (139.70)	5.06 (128.50)
2510	10	30A	600V	M4 (#8)	6.63 (168.30)	6.18 (157.10)
2512	12	30A	600V	M4 (#8)	7.75 (196.80)	7.31 (185.60)
2602	2	65A	600V	M5 (#10)	2.51 (63.80)	2.06 (52.40)
2604	4	65A	600V	M5 (#10)	3.89 (98.70)	3.44 (87.30)
2606	6	65A	600V	M5 (#10)	5.26 (133.60)	4.81 (122.20)
2608	8	65A	600V	M5 (#10)	6.63 (168.50)	6.19 (157.10)
2610	10	65A	600V	M5 (#10)	8.01 (203.40)	7.56 (192.00)

Terminal Block Jumpers

Combines independent circuits on Terminal Blocks (above) and ST-Blade Fuse Blocks 5035 and 5037

Bus Material	Nickel-Plated Brass
Continuous Amperage	Equivalent to matching block

Part #	Description	Retail Pack
9218	For use with 20A Terminal Blocks	5
9217	For use with 30A Terminal Blocks and ST-Blade Fuse Blocks 5035 & 5037	5
9216	For use with 65A Terminal Blocks	5

Related Product



ST-Blade Fuse Blocks p. 66



9218

9217

9216

TECH tip™

Connector & Insulators Explained

Tin-plated copper buses provide maximum conductivity and corrosion resistance.

Insert-molded stainless steel studs eliminate the need for securing nuts and allow high torquing for excellent electrical contact.

UL 94-V0 rated UL 94-V0 rated base materials have flame retardants and will self extinguish if a flame source is removed.

Terminal Screws incorporate stainless steel split ring lock washers and captive star-type lock washers keep connections tight in high vibration environments.

One-Piece Serrated Flange Nuts ensure correct and secure connections which do not cause resistance.

Insulating covers meet ABYC and USCG insulation requirements.

PowerBar - 600A Common BusBars

High amperage BusBar with 3/8" terminal studs

Continuous Rating	545A AC / 600A DC
Voltage Max. Operating	300V AC / 48V DC
Mounting Hardware	#10 (M5) Screws
Bus Material	Tin-Plated Copper C11000
Regulatory CE certified	

Part #	Terminal Studs	Terminal Screws	[A] Length in (mm)	[B] Mounting Centers in (mm)
2104	4 x 3/8" -16	4 x #8-32	7.0 (177.8)	6.25 (158.74)
2107	8 x 3/8" -16	4 x #8-32	11.375 (288.93)	10.375 (263.53)
2708	Cover For 2104			



2104



2107

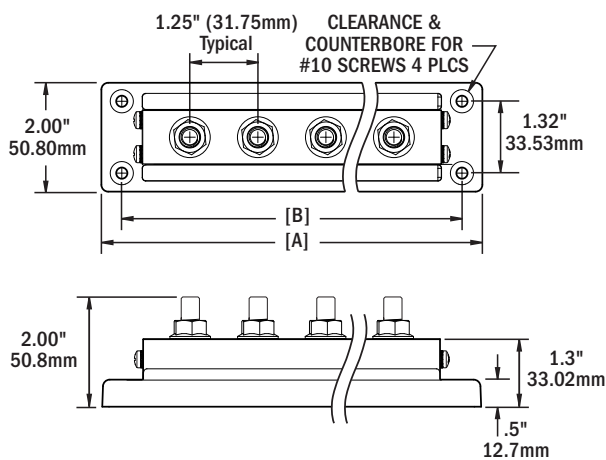

2708

Related Products



MaxiBus Cover 2718
page 104

PowerBar 1000 - 1000A Common BusBar

Complex wiring systems require a single point to consolidate large and small conductors. The PowerBar 1000 offers a busbar with various size studs and screws to connect conductors and fuse blocks.

- For large complex wiring systems
- Tin-plated pure electrical copper for maximum conductivity
- Stepped bus design offers two elevations for conductors which doubles the density of the wire loom compared to traditional bus bars
- Busbar and fuse block elevations match common fuse blocks allowing for multiple fuse block attachment, eliminating the need for connecting cables
- One-piece serrated flange nuts ensure correct and secure connections
- Stainless steel 8-32 screws with captive lock washers for securing smaller gauge wires
- Busbar may be cut to a shorter length to accommodate constricted spaces
- Bi-directional busbar end caps allow the ganging of additional busbars
- Snap on insulating cover meets ABYC and USCG requirements and includes label recess
- Models available to accommodate either 3/8" or 5/16" terminals

Continuous Rating	1000A
Voltage Max. Operating	150V AC / 48V DC
Mounting Hardware	#10 (M5) Screws
Bus Material	Tin-Plated Copper C11000

Part #	Cover	Terminal Studs	Terminal Screws
1990	Yes	8 x 3/8"-16	5 x #10-32, 11 x #8-32
1991	Yes	12 x 3/8"-16	5 x #10-32, 11 x #8-32
1992	Yes	8 x 5/16"-18	5 x #10-32, 11 x #8-32
1993	Yes	12 x 5/16"-18	5 x #10-32, 11 x #8-32
2730B	PowerBar 1990 and 1992 Cover	--	--
2731B	PowerBar 1991 and 1993 Cover	--	--

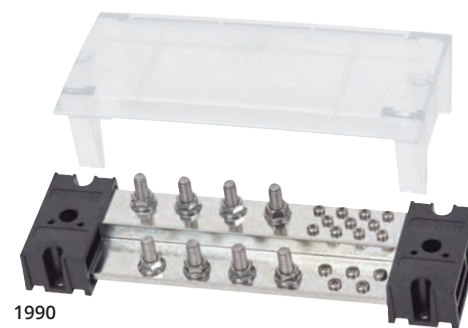

1990



1991



Related Products

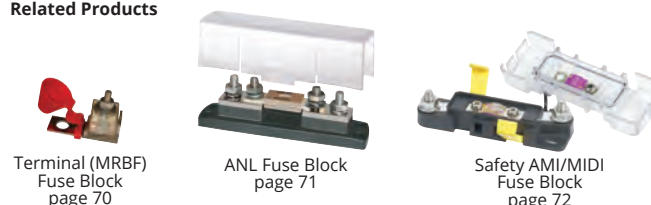

Terminal (MRBF)
Fuse Block
page 70

ANL Fuse Block
page 71

Safety AMI/MIDI
Fuse Block
page 72

TECH tip™

PowerBar 1000 Explained

The PowerBar 1000 offers mounting and application flexibility. Coupled with security features like serrated flange nuts and an insulating cover, the PowerBar 1000 is an organized and secure termination point for the boat or vehicle's critical electrical connections.

PowerBar 1000 used as a grounding bus and high density collecting point for both large and small gauge conductors.

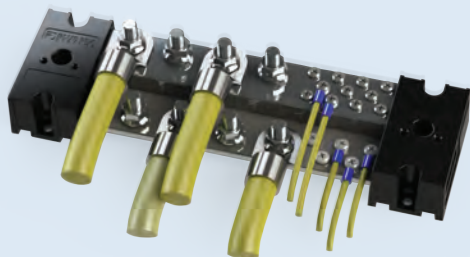

PowerBar 1000 used as a high amperage positive distribution bus for various types and sizes of fuses as well as high density collecting point for both large and small gauge conductors. Typically this configuration would include the snap on insulating cover but pictured without to better show fuse blocks.

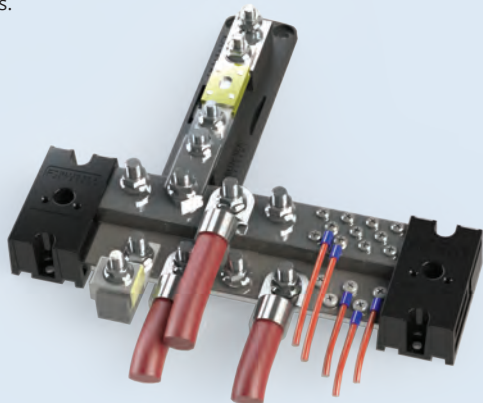

PowerBar 1000 used as a positive distribution bus and high density collecting point for both large and small gauge conductors. Pictured with snap on insulating cover.

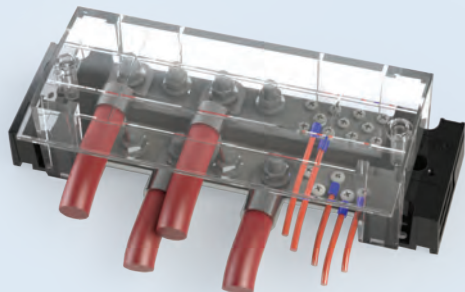

Gang two or more PowerBars together



Battery Terminal Mount BusBars

Easily add positive and negative busbars to the battery terminals

- Easily add positive and negative busbars directly to a threaded-post battery terminal
- Tin-plated pure electrical copper for maximum conductivity
- Insulating covers meet ABYC/USCG insulation requirements
- Screw terminals for securing wires
- 2340 Includes four 16-14 AWG and four 12-10 AWG Nylon Insulated ring terminals

Continuous Rating	100A DC
Voltage Max. Operating	32V DC
Bus Material	Tin-Plated Copper C11000
Mounting Thru-hole	Clearance for 3/8" (M10) stud
Screw Terminal	#8-32 Screws with Captive Star Lock washer

Part #	Description
2340	Positive + Negative
2341B	Positive
2342B	Negative

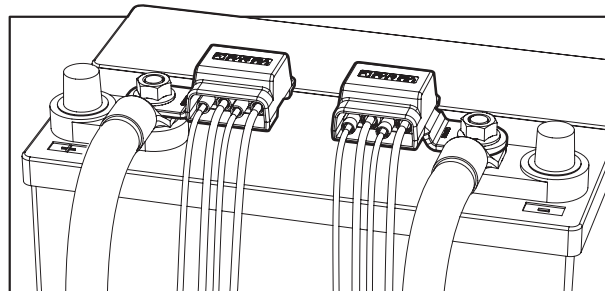
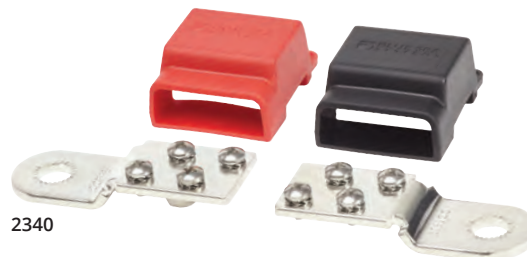

Related Products



ST-Blade Battery Terminal Mount Fuse Block Kit page 65

PowerPost Cable Connectors

Insulated single stainless steel stud terminates multiple large conductors



- One-piece serrated flange nuts ensure correct and secure connections

Continuous Rating	Not rated - stacked on post and is determined by wire and terminals used.
Voltage Max. Operating	48V DC
Mounting Hardware	#8 Screws (2010, 2011) 1/4" Screws (2001, 2002, 2003)
Regulatory	CE certified

Part #	Terminal Stud
2010	#10-32 x 5/8"
2011	1/4"-20 x 3/4"
2001	1/4"-20 x 1-1/16"
2002	5/16"-18 x 7/8"
2003	3/8"-16 x 7/8"

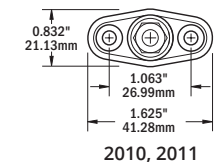
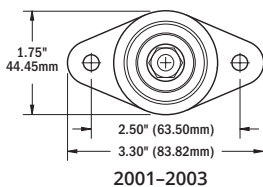

PowerPost Plus Cable Connectors

Enables connection of multiple smaller wires in spaces where a traditional bus bar may not fit

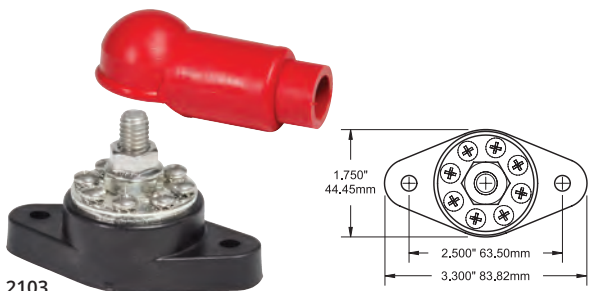

- Allows small wire connections at high amperage cable connections
- One-piece serrated flange nut ensures correct and secure connections

Continuous Rating	150A DC
Voltage Max. Operating	48V DC
Mounting Hardware	1/4" Screws
Bus Material	Tin-Plated Copper
Regulatory	CE certified

Part #	Terminal Stud	Terminal Screws
2101	1/4"-20 x 1"	8 x #8-32
2102	5/16"-18 x 3/4"	8 x #8-32
2103	3/8"-16 x 3/4"	8 x #8-32

Dual PowerPost Cable Connectors

Provides a termination point for extending the length of outboard harnesses or other conductors

- Designed for connecting high amperage conductors
- 2018 is also designed for outboard engine installation when factory cables need to be extended
- One-piece serrated flange nuts ensure correct and secure connections

Continuous Rating	Not rated - amperage flows between terminals stacked on post and is determined by wire and terminals used.
Voltage Max. Operating	48V DC
Mounting Hardware	#10 (M5) Screws



Part #	Terminal Studs	Insulating Cover	Stud Height A in (mm)	Stud Height B in (mm)
2016	2 x 5/16"-18	Yes	1.50 (38.1)	1.50 (38.1)
2016100B	2 x 5/16"-18	--	1.50 (38.1)	1.50 (38.1)
2017	2 x 3/8"-16	Yes	1.63 (41.3)	1.63 (41.3)
2017100B	2 x 3/8"-16	--	1.63 (41.3)	1.63 (41.3)
2018	1 x 5/16"-18, 1 x 3/8"-16	Yes	1.50 (38.1)	1.63 (41.3)
2018100B	1 x 5/16"-18, 1 x 3/8"-16	--	1.50 (38.1)	1.63 (41.3)

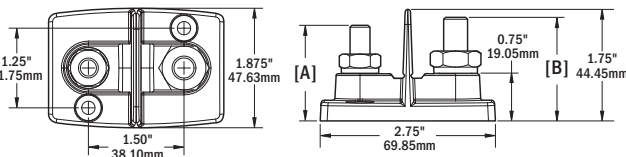

Terminal Feed Through Connectors

Eliminates chafe and provides strain relief when passing high current through hulls, decks and bulkheads

- Protects large cables that are subject to chafing when passed through holes
- The large terminals have a mounting face that can be gasketed or bedded to provide a water-tight installation
- One-piece serrated flange nut ensures correct and secure connections







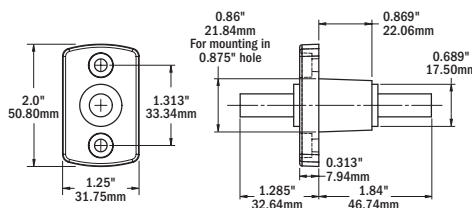

Stud Material	Tin-Plated Copper Alloy
Mounting Hardware	#10 (M5) Screws
Regulatory	Rated IP66 - protected against powerful water jets















Part #	Terminal Stud	Amps	Volts	Color
2201	5/16"-18	250A	48V	Black
2202	5/16"-18	250A	48V	Red
2203	3/8"-16	250A	48V	Black
2204	3/8"-16	250A	48V	Red







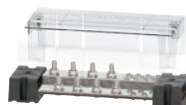

Connector Comparison

Product	Water-Resistant 100A BusBar	MiniBus 100A Common BusBars			Battery Mount BusBars	DualBus 100A Common BusBars		DualBus Plus 150A Common BusBars
								
Part #	NEW 2356 & 2356100	2304	2305	2306	2340	2701	2702	2722 & 2723
Page Number	102	102			107	103		103
Continuous Rating	100A AC / 100A DC	100A AC / 100A DC			100A DC	100A AC / 100A DC		130A AC / 150A DC
Max. Voltage	300V AC / 48V DC	300V AC / 48V DC			32V DC	300V AC / 48V DC		300V AC / 48V DC
Terminal Screw	4 × #8-32	5 × #8-32	--	6 × #8-32	4 per bus × #8-32	5 per bus × #8-32	10 per bus × #8-32	5 per bus × #8-32
Terminal Stud	--	2 × #10-32	4 × #10-32	--	--	--	--	2 per bus × 1/4"-20 or 2 per bus × 5/16"-18
Insulating Cover	Included	Cover available			Included	Cover available		Included

Product	150A Common BusBars				MaxiBus 250A Common BusBars		
							
Part #	2300	2312	2307	2128	2105	2127	2126
Page Number	103				104		
Continuous Rating	130A AC / 150A DC				250A AC / 250A DC		
Max. Voltage	300V AC / 48V DC				300V AC / 48V DC		
Terminal Screw	10 × #8-32	20 × #8-32	--	6 × #10-24	12 × #10-24	--	--
Terminal Stud	2 × 1/4"-20		4 × 1/4"-20	2 × 5/16"-18	2 × 5/16"-18	4 × 5/16"-18	6 × 5/16"-18
Insulating Cover	Cover available				Cover available		

Product	PowerBar Common BusBar	Terminal Blocks			PowerBar 1000A	
						
Part #	2019	24XX	25XX	26XX	1992 & 1993	1990 & 1991
Page Number	104	105			106	
Continuous Rating	Determined by wire up to 200A	20A AC / 20A DC	30A AC / 30A DC	65A AC / 65A DC	1000A	
Max. Voltage	48V DC	300V AC / 300V DC	600V AC / 600V DC	600V AC / 600V DC	150V AC / 48V DC	
Terminal Screw	--	#6	#8	#10	5 × #10-24, 11 × #8-32	5 × #10-24, 11 × #8-32
Terminal Stud	2 × 3/8"-16	--	--	--	8 × 5/16"-8 or 12 × 5/16"-8	8 × 3/8"-8 or 12 × 3/8"-8
Insulating Cover	Included	--	--	--	Included	

Product	PowerBar 600A Common BusBars		Terminal Feed Through Connectors	PowerPost Cable Connectors		PowerPost Plus	Dual PowerPost
							
Part #	2104	2107	2201-2204	2100 & 2101	2001-2003	2101-2103	2016-2018
Page Number	106		108	108		108	108
Continuous Rating	545A AC / 600A DC		250A DC	Determined by wire and terminals		150A DC	Determined by wire and terminals
Max. Voltage	300V AC / 48V DC		48V DC	48V DC		48V DC	48V DC
Terminal Screw	4 × #8-32		--	--		8 × #8-32	--
Terminal Stud	4 × 3/8"-16	8 × 3/8"-16	5/16"-18 or 3/8"-16	1 × #10-32 or 1 × 1/4"-20	1 × 1/4"-20 or 1 × 5/16"-18 or 1 × 3/8"-16	1 × 1/4"-20 or 1 × 5/16"-18 or 1 × 3/8"-16	2 × 5/16"-18 or 2 × 3/8"-16 or 1 × 5/16"-18 and 1 × 3/8"-16
Insulating Cover	Cover available		--	Included		Included	Included

Stud Mount Insulating Boots NEW

Quickly and easily insulate conductive posts and studs

- Press-fit design works with all 5/16" (M8) and 3/8" (M10) posts and studs
- Ideal for ML-Series Remote Battery Switches, Solenoids & Automatic Charging Relays, battery terminals, power posts, bus bars, battery switches, and much more.
- For use with insulated ring terminals and lugs only

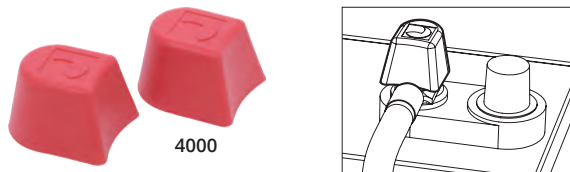

Part #	Cable Size (AWG)	Color	Package
4000	All	Red	Retail/2

Rotating CableCap Insulators

Insulates battery terminals which have integral wing nut posts

- Top rotates 360 degrees to allow cable entry from any angle

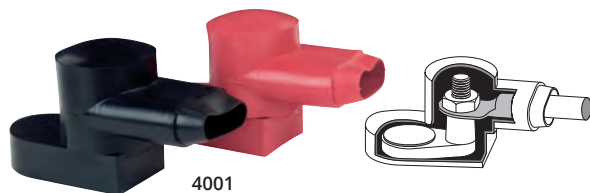

Part #	Cable Size (AWG)	Color	Package
4001	All	Red/Black	Pair/Retail
9030B	All	Black	Bulk/Not for retail
9031B	All	Red	Bulk/Not for retail

Standard CableCap Insulators

Insulates battery terminals which have added adapter terminals

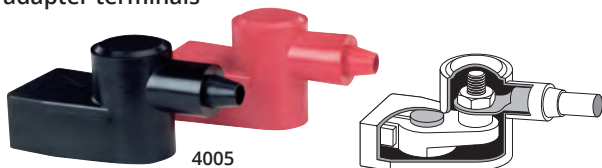

Part #	Cable Size (AWG)	Color	Package
4005	4, 2, 1	Red/Black	Pair/Retail
4006	1/0, 2/0	Red/Black	Pair/Retail
9038B	4, 2, 1	Black	Bulk/Not for retail
9039B	4, 2, 1	Red	Bulk/Not for retail
9040B	1/0, 2/0	Black	Bulk/Not for retail
9041B	1/0, 2/0	Red	Bulk/Not for retail

Automotive CableCap Insulators

Insulates battery terminals which have standard automotive posts



Part #	Cable Size (AWG)	Color	Package
4016	4, 2, 1	Red/Black	Pair/Retail
4017	1/0, 2/0	Red/Black	Pair/Retail
9176B	1/0, 2/0	Red	Bulk/Not for retail
9177B	1/0, 2/0	Black	Bulk/Not for retail

Square CableCap Insulators

Insulates battery terminals which have in-line dual posts



Part #	Cable Size (AWG)	Color	Package
4018	1/0	Red/Black	Pair/Retail
4019B	1/0	Red	Bulk/Not for retail
4020B	1/0	Black	Bulk/Not for retail

Stud CableCap Insulators

Insulates single stud on alternators, starters, windlasses and high amperage termination points

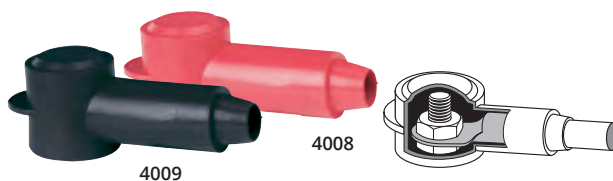

Part #	Cable Size (AWG)	Color	Package
4008	18-10	Red	Retail/3
4009	18-10	Black	Retail/3
4010	8-4	Red	Retail/2
4011	8-4	Black	Retail/2
4012	2-2/0	Red	Retail/1
4013	2-2/0	Black	Retail/1
4014	3/0-4/0	Red	Retail/1
4015	3/0-4/0	Black	Retail/1

PowerPost Insulator

Provides electrical insulation for single studs and large cables

- Included with 2001, 2002, 2003, 2101, 2102, 2103, and 2019



Part #	Cable Size (AWG)	Color	Package
4004	up to 2/0	Red	Retail

Dual Entry PowerPost Cable Insulators

Protects against accidental short circuits

- For use with Dual PowerPost Cable Connectors (p. 102)

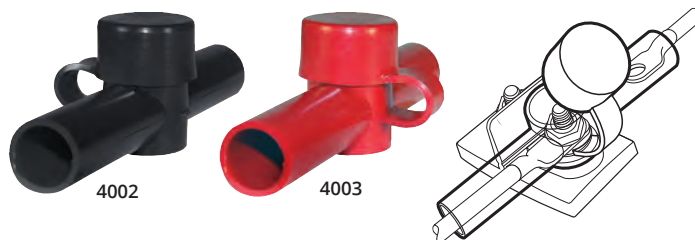

Part #	Cable Size (AWG)	Cable Entry Size in (mm)	Color	Package
4002	up to 2/0	0.7 (17.8)	Black	Retail/1
4003	up to 2/0	0.7 (17.8)	Red	Retail/1

CableClams

Provides a waterproof pass-through for antenna cables without requiring removal of the factory installed connector

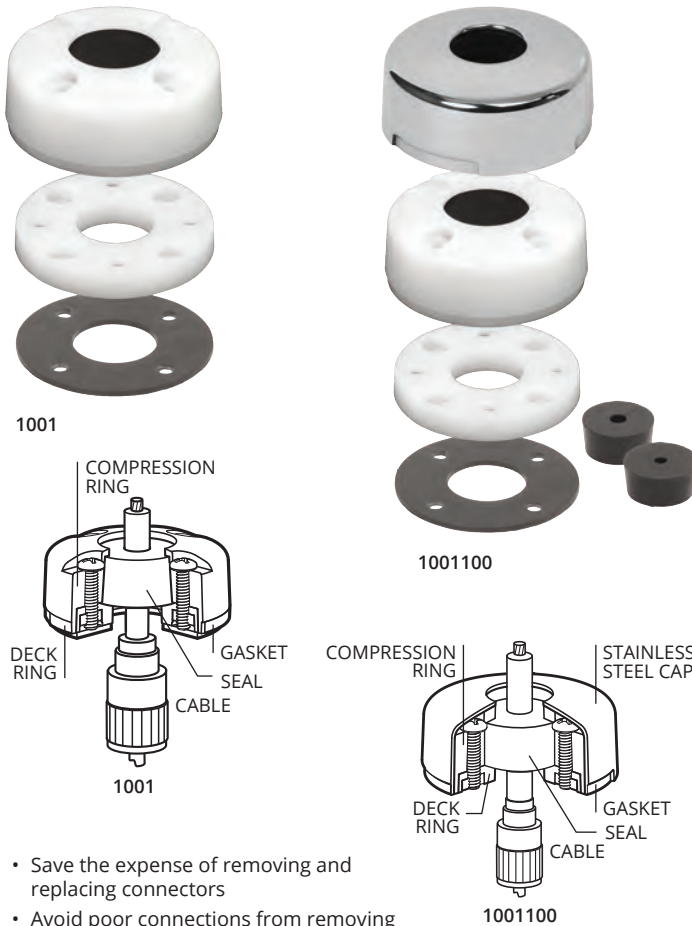

- Save the expense of removing and replacing connectors
- Avoid poor connections from removing factory connectors
- Use 1001, 1001100 for GPS cables, 1002, 1002100 for VHF cables, 1003, 1003100 for Radar cables
- 1001100, 1002100, 1003100 includes pre-drilled and slit rubber seals for easier installation
- 1001100, 1002100, 1003100 includes a 316 stainless steel dress cap which conceals mounting hardware and matches other deck hardware
- Stainless steel fasteners included

Ring Material	UV-Stabilized Thermoplastic
Seal Material	UV-Stabilized Buna-N Rubber

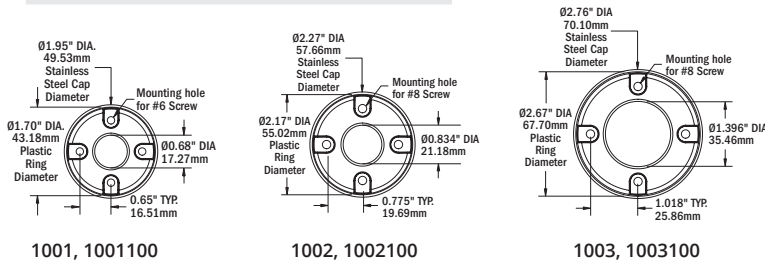

Part #	Seals Included	Max. Connector Diameter in (mm)	Max. Cable Diameter in (mm)	Dress Cap	Mounting Holes Accept
1001	--	0.68 (17.0)	0.31 (8.0)	--	#6 x 7/8" screws
1001100	3	0.68 (17.0)	0.31 (8.0)	Yes	#6 x 7/8" screws
1002	--	0.83 (21.0)	0.44 (11.0)	--	#8 x 7/8" screws
1002100	3	0.83 (21.0)	0.44 (11.0)	Yes	#8 x 7/8" screws
1003	--	1.40 (35.0)	0.56 (14.0)	--	#8 x 7/8" screws
1003100	1	1.40 (35.0)	0.56 (14.0)	Yes	#8 x 7/8" screws

Side-Entry CableClams with Stainless Steel Dress Cap

Provides a water-resistant side-entry for cables without requiring removal of the factory installed connector

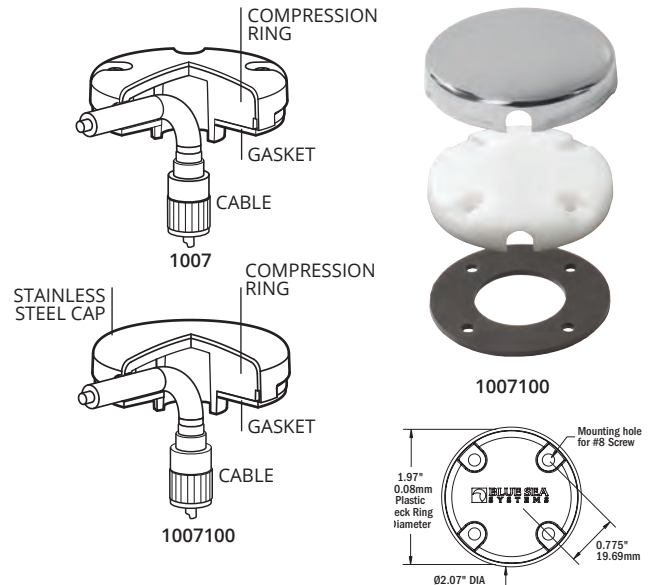

- Simple one-piece design for easy side-entry installations
- Low profile, contoured edge reduces the risk of tangling lines
- 1007100 includes a 316 stainless steel dress cap which conceals mounting hardware and matches other deck hardware
- Stainless steel fasteners included

Ring Material	UV-Stabilized Thermoplastic
Seal Material	UV-Stabilized Buna-N Rubber

Part #	Max. Connector Diameter in (mm)	Max. Cable Diameter in (mm)	Dress Cap	Mounting Holes Accept
1007	1.00 (25.40)	0.28 (7.112)	--	#8 x 7/8" screws
1007100	1.00 (25.40)	0.28 (7.112)	Yes	#8 x 7/8" screws



POWER DISTRIBUTION

Circuit Breaker Switch Water-Resistant

115



Designed for exposed mounting applications.

Contura Switch Water-Resistant

116



Complements existing controls commonly used on many boats.

WeatherDeck® Waterproof

117



Designed for open-cockpit and flybridge applications.

360 Panel System

118



Designed with an open frame to mount a broad selection of modules allowing multiple functions to be combined in a single panel.

Traditional Metal

119



Suited for use as drop-in replacements or extensions to existing panels.



POWER DISTRIBUTION

DC and AC Circuit Breaker

120



Designed to distribute current from a high amperage input into lower amperage circuits.

AC RCBO Circuit Breaker

128



Reduces the risk of fire and shock hazards caused by defects in boat appliances and circuit wiring.

AC Source Selection

129



Select between multiple AC sources to supply power to the AC Branch distribution system.

AC/DC Combination

132



Combines switching, circuit protection, source selection and monitoring into a single panel.

Custom 360

134



Design and order custom panels online.



Waterproof & Water-Resistant Panels

Integrated overcurrent protection and switching built to withstand harsh environments for every application.

Water-Resistant Circuit Breaker Switch Panels

Designed for Wet Environments - IP66

Water-Resistant Circuit Breaker Switch Panels utilize 15A illuminated circuit breakers that provide on indication and switching in one. Integrated switch boot and panel gasket provide IP66 water resistance for wet environments. Available in gray and camo pattern.



Contura Switch Water-Resistant Panels

Contemporary Design For Wet Environments - IP66

Using industry standard Contura switches, the Blue Sea Systems Contura Switch Water Resistant Panels are designed to perform above deck, as well as complement any interior. Fuse models are available in a classic gray finish, and circuit breaker models are available in white or black.



WeatherDeck® Waterproof Panels

Designed For Extreme Environments - IP67

The WeatherDeck Panels are Blue Sea Systems most waterproof panels and their contemporary appearance adds style to any boat. Available in switch only, fuse, and circuit breaker models, the WeatherDeck Panels can be mounted in four orientations for maximum versatility.



Water-Resistant Circuit Breaker Switch Panels

Designed for exposed mounting applications

- Illuminated 15A circuit breakers provide switching, ON indication and overcurrent protection
- Industry-standard sizes and mounting allow these panels to be easily retrofitted in an existing application
- Polycarbonate/ABS panel surface is UV-stabilized, flame retardant, and will not corrode
- Silicon breaker boots and gasket protects against water ingress
- Low profile makes it easy to install in tight spaces
- Fast-on circuit breaker connectors make it quick to wire
- Two-wire connection for powering all panels is simple and requires #10 ring terminals. Terminals screw to bus bars for secure connections
- 4321 & 4324 include a 12/24V 2.1A DC USB Charger (p. 26)
- Set of 15 square format circuit labels are included, and are easy to replace. Additional standard or custom labels are available through Blue Sea Systems

Nominal Voltage	12V DC
Amperage Max. Operating	45A
Terminal Type	1/4" Male quick connect
Hardware	Stainless Steel #6 x 5/8" mounting screws
Ring Terminal Size	M5 (#10)
Regulatory	
Panel front is IP66 when mounted with gasket in place - protected against powerful water jets (see inside back cover)	

Part #	Description	Color	Width in (mm)	Height in (mm)	Depth in (mm)	Width Mounting Centers in (mm)	Height Mounting Centers in (mm)
4320	4 positions	Gray	4.625 (117.47)	5.0 (127)	1.75 (44.45)	4.125 (104.77)	4.437 (112.69)
4321	4 pos. + 12 Volt Socket & Dual USB Charger	Gray	4.625 (117.47)	6.625 (168.27)	1.75 (44.45)	4.125 (104.77)	6.125 (155.57)
4322	6 positions	Gray	4.625 (117.47)	6.625 (168.27)	1.75 (44.45)	4.125 (104.77)	6.125 (155.57)
4323	4 positions	Camo	4.625 (117.47)	5.0 (127)	1.75 (44.45)	4.125 (104.77)	4.437 (112.69)
4324	4 pos. + 12 Volt Socket & Dual USB Charger	Camo	4.625 (117.47)	6.625 (168.27)	1.75 (44.45)	4.125 (104.77)	6.125 (155.57)
4325	6 positions	Camo	4.625 (117.47)	6.625 (168.27)	1.75 (44.45)	4.125 (104.77)	6.125 (155.57)



4320 Gray

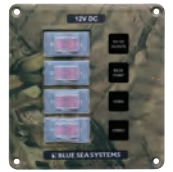

4323 Camo



4321 Gray



4324 Camo



4322 Gray

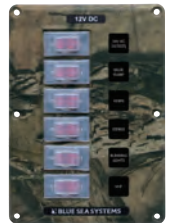

4325 Camo

Contura Switch Water-Resistant Bilge Panels

Consolidated control and circuit protection for up to four bilge pumps

EXPANDED OFFERING

- Designed for 12 or 24V DC systems
- Watertight mounting gasket
- Pre-wired for easy installation
- ON indicating LEDs embedded in all switches
- (ON)-OFF-ON Contura Switches and 15A AGC Fuses

NOTE: Labels are not backlit

Voltage Max. Operating	24V DC
Amperage Operating Current	18 Milliamps per illuminated LED
Switch Rating	20A @ 12V DC, 15A @ 24V DC
Circuit Breaker Rating	15A
Fuse Holder Rating	20A Max. (15A fuses included)
Panel Cumulative Rating	45A

Regulatory CE marked
Panel front is IP66 when mounted with gasket in place - protected against powerful water jets (see inside back cover)

Part #	Color	Contura Switches	AGC®/MDL® Fuse Holders	Width in (mm)	Height in (mm)	Depth in (mm)
8263	Gray	1	1	2.25 (57.15)	3.75 (95.25)	3.00 (76.20)
8664	Gray	2	2	3.34 (84.84)	3.75 (95.25)	3.00 (76.20)
8665	Gray	3	3	5.25 (133.35)	3.75 (95.25)	3.00 (76.20)
8666	Gray	4	4	5.25 (133.35)	3.75 (95.25)	3.00 (76.20)



8263



8664



8665



8666

Contura Switch Water-Resistant Panels

Designed for open-cockpit and flybridge applications using switches to complement existing controls commonly used on many boats

- Designed for 12 or 24V DC systems
- Watertight mounting gasket
- ON indicating LEDs embedded in all switches
- Includes Small Format Label Set 8217 (Gray) or 8214 (Black) * (p. 156)
- 8121, 8421 & 8521 include a 12/24V DC 4.8A USB Charger (p. 26)

NOTE: Labels are not backlit

Voltage Max. Operating	24V DC
Amperage Operating Current	18 Milliamps per illuminated LED
Switch Rating	20A @ 12V DC, 15A @ 24V DC
Circuit Breaker Rating	15A
Fuse Holder Rating	20A Max. (15A fuses included)
Panel Cumulative Rating	45A (all except 8 position panels) 90A (8 position panels)

Regulatory

CE marked
 Panel front is IP66 when mounted with gasket in place - protected against powerful water jets (see inside back cover)
 CIRCUIT BREAKER MODELS ONLY—Meet UL 1500 and ISO 8846 external ignition protection requirements

EXPANDED OFFERING



8374



8372



8373



8521



8371

IGNITION PROTECTED



8272



8271



8261



8274



8421



8273



8121



8053*

Part #	Color	4.8A Dual USB Charger	Push Button Circuit Breakers	AGC®/MDL® Fuse Holders	Width in (mm)	Height in (mm)	Depth in (mm)
8274	White	--	3	--	4.50 (114.30)	3.75 (95.25)	3.25 (82.55)
8272	White	--	4	--	5.25 (133.35)	4.25 (107.95)	3.25 (82.55)
8273	White	--	6	--	4.50 (114.30)	7.50 (190.50)	3.25 (82.55)
8271	White	--	8	--	9.37 (238.00)	4.25 (107.95)	3.25 (82.55)
8421	White	1	5	--	4.50 (114.30)	7.50 (190.50)	3.25 (82.55)
8374	Black	--	3	--	4.50 (114.30)	3.75 (95.25)	3.25 (82.55)
8372	Black	--	4	--	5.25 (133.35)	4.25 (107.95)	3.25 (82.55)
8373	Black	--	6	--	4.50 (114.30)	7.50 (190.50)	3.25 (82.55)
8371	Black	--	8	--	9.37 (238.00)	4.25 (107.95)	3.25 (82.55)
8521	Black	1	5	--	4.50 (114.30)	7.50 (190.50)	3.25 (82.55)
8054*	Gray	--	--	3	5.25 (133.35)	3.75 (95.25)	3.00 (76.20)
8262	Gray	--	--	4	5.25 (133.35)	3.75 (95.25)	3.00 (76.20)
8053*	Gray	--	--	6	5.25 (133.35)	7.50 (190.50)	3.00 (76.20)
8261	Gray	--	--	8	9.37 (238.00)	3.75 (95.25)	3.00 (76.20)
8121	Gray	1	--	5	5.25 (133.35)	7.50 (190.50)	3.00 (76.20)



8054*



8262

* 8054, 8053 and 8121 include Large Format Label Set 8030 (p. 156)

WeatherDeck® Waterproof Panels

Designed for open-cockpit and flybridge applications

- **Fuse Model:** Bicolored LEDs illuminate circuit labels to quickly identify OFF (Red), ON (Green), or Blown (No color) circuits
- **Circuit Breaker Model:** Green LEDs illuminate circuit labels
- **Fuse and Circuit Breaker Models:**
 - Backlighting is compatible with DeckHand Dimmers (p. 29)
 - Independent label backlighting allows switching and dimming
- **Switch Only Model:** No circuit protection or illuminated circuit labels
- Integrated switch guards reduce the risk of accidental switching
- Panels can be mounted in four different orientations
- Panel front rated IP67 when properly mounted with watertight mounting gasket
- UV stabilized weather-resistant faceplate snaps on and off providing access to components and concealing mounting screws
- Square Format Label Set 4215 included (p. 156)

Circuit Breaker Panel	24V DC
Voltage Max. Operating	24V DC
Amperage Max. Operating	15A @ 12V DC (per circuit) 9A @ 24V DC (per circuit)
Amperage Operating Current (backlight)	10mA/Illuminated Circuit
Panel Cumulative Rating	45A
Switch Rating	15 Amps Maximum
Backlighting Voltage	12V or 24V DC
Backlighting Amperage Draw	10mA/Illuminated Circuit
Circuit Breaker Rating	15A
Fuse Panel	
Voltage Max. Operating	12V DC
Amperage Max. Operating	15A @ 12V DC (per circuit)
Amperage Operating Current (backlight)	10mA/Illuminated Circuit
Panel Cumulative Rating	2 Position: 30A 4 Position: 60A 6 Position: 90A 8 Position: 100A
Switch Rating	15A Max.
Backlighting Voltage	12V DC Nominal
Fuses Available	1-30A
Switch Only Panel	
Voltage Max. Operating	24V DC
Amperage Max. Operating	15A @ 12V DC (per circuit)
Switch Rating	15A Max.
Regulatory	
IP67 - protected against immersion up to 1 meter for 30 minutes (see inside back cover)	

Part #	Pos.	Circuit Breakers	Fuses	Label Backlight	Volts	Width in (mm)	Height in (mm)	Depth in (mm)	Width Mounting Centers in (mm)	Height Mounting Centers in (mm)
4374	4	Yes	--	Yes	12/24V	4.25 (107.95)	4.30 (109.22)	3.50 (88.90)	3.69 (93.73)	3.74 (95.00)
4376	6	Yes	--	Yes	12/24V	4.25 (107.95)	6.00 (152.40)	3.50 (88.90)	3.69 (93.73)	5.44 (138.18)
4378	8	Yes	--	Yes	12/24V	4.25 (107.95)	7.70 (195.58)	3.50 (88.90)	3.69 (93.73)	7.14 (181.36)
4302	2	--	Yes	Yes	12V	3.88 (98.55)	2.60 (66.04)	2.50 (63.50)	3.31 (84.07)	2.04 (51.82)
4304	4	--	Yes	Yes	12V	3.88 (98.55)	4.30 (109.22)	2.50 (63.50)	3.31 (84.07)	3.74 (95.00)
4306	6	--	Yes	Yes	12V	3.88 (98.55)	6.00 (152.40)	2.50 (63.50)	3.31 (84.07)	5.44 (138.18)
4308	8	--	Yes	Yes	12V	3.88 (98.55)	7.70 (195.58)	2.50 (63.50)	3.31 (84.07)	7.14 (181.36)
4303	2	--	--	--	12/24V	3.88 (98.55)	2.60 (66.04)	2.50 (63.50)	3.31 (84.07)	2.04 (51.82)
4305	4	--	--	--	12/24V	3.88 (98.55)	4.30 (109.22)	2.50 (63.50)	3.31 (84.07)	3.74 (95.00)
4307	6	--	--	--	12/24V	3.88 (98.55)	6.00 (152.40)	2.50 (63.50)	3.31 (84.07)	5.44 (138.18)
4309	8	--	--	--	12/24V	3.88 (98.55)	7.70 (195.58)	2.50 (63.50)	3.31 (84.07)	7.14 (181.36)



4374 CLB Circuit breakers



4302 ATO/ATC Fuses
4303 Switch only, no backlight or fuses



4376 CLB Circuit breakers



4304 ATO/ATC Fuses
4305 Switch only, no backlight or fuses



4378 CLB Circuit breakers



4306 ATO/ATC Fuses
4307 Switch only, no backlight or fuses



4308 ATO/ATC Fuses
4309 Switch only, no backlight or fuses

360 Panel System



Sabre Yachts uses Blue Sea Systems 360 Panels aboard their boats including the 42 Salon Express

Innovative Design Meets a Wide Range of Flexibility

The 360 Panel System uses an open frame to mount a broad selection of modules allowing multiple functions to be combined in a single panel. This innovative design offers a wide choice of panel features, accommodates future changes, and permits rapid assembly and shipping time. With options ranging from battery management to source selection, the 360 Panel System provides unmatched design flexibility. If you do not find the panel you are looking for in the stock panel offering, please go to page 134 to find out how to create and order a custom panel that will work for your specific application.

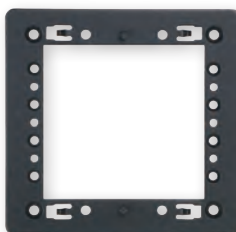

Open frame allows future replacement or upgrade of panel modules

Related Products

 Push Button Circuit Breaker Boot page 77

 Push Button Reset-Only Circuit Breaker page 77

 A-Series Rocker Circuit Breakers page 85

 ELCI Main Circuit Breakers page 89

 Analog Meters page 142

 Digital Meters page 148

 360 Panel Insulating Back Cover page 154

 Square Format Labels page 156

Traditional Metal Panels



Blue Sea Systems' Traditional Metal Panels are a complementary fit on Hunt Yachts Surfhunter 33

Styled to Match Existing Panels

The Traditional Metal Panels are suited for use as extensions to existing panels or as full replacements. All panels are pre-wired and include LEDs in all positions. Choose from over 100 stock panels ranging from simple circuit breaker models to complex multi-source AC configurations.

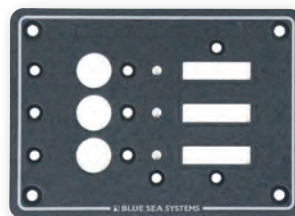

Marine grade aluminum frame securely holds fixed panel components and is chemically treated to resist corrosion (aluminum frame not sold separately)

Related Products



A-Series Toggle Circuit Breakers page 84



C-Series Toggle Circuit Breaker page 86



ELCI Main Circuit Breakers page 89



Digital Meters page 148



Analog Meters page 142



LED Indicator Lights page 155

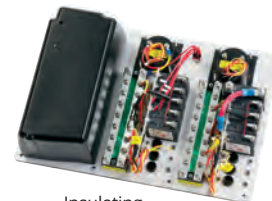

Insulating Back Cover page 155



Large Format Labels page 156

DC Branch Circuit Breaker Panels

EXPANDED OFFERING

Distribute current from a high amperage input into lower amperage circuits

Features

- ON-indicating LEDs for select models†
- Backlit label positions for select models†
- Panels with voltmeters include a toggle switch to monitor voltage on up to three battery banks

Component References

- A-Series Circuit Breakers (p. 84)
- Push Button Reset-Only Circuit Breakers (p. 77)
- ON-OFF, SPST Rocker Switches (p. 96)
- 360 Panels include 4205 label set (p. 157)
- Traditional Metal Panels include 8030 label set (p. 157)
- DC Digital Multimeter (p. 148)
- DC Analog Meters (p. 142)
- Amber ON-indicating LEDs (p. 155)
- DC M2 Multimeter 1830 (p. 145)
- 4.8A USB Charger & 12V Socket (p. 26, 27)

† Panels with Push Button Circuit Breakers do not include ON-indicating LEDs or backlit label positions



	8025	1216	1455	1495	1459
Style	Traditional Metal	360 Panel System	360 Panel System	360 Panel System	360 Panel System
Total Positions	3 Positions	4 Positions	4 Positions	4 Positions	4 Positions
Circuit Breakers	3 A-Series, 15A (7210)	4 A-Series, 15A (7403)	4 Push Button, 10A (7054)	4 A-Series, 15A (7403)	4 Push Button, 10A (7054)
Rocker Switches	--	--	4 ON-OFF, SPST (7480)	--	4 ON-OFF, SPST (7480)
Dual USB / Dash Socket	--	--	--	12/24V Dual USB 4.8A (1045) 12V Dash Socket (1011)	--
Nominal Voltage	12/24V DC	12V DC	12V DC	12V DC	12V DC
Maximum Amperage	100A	100A	40A	100A	40A
DC Meter	--	--	--	--	8-16V (8003)
Width x Height in (mm)	5.25 (133.35) x 4.75 (120.65)	4.88 (123.83) x 4.75 (120.65)	4.88 (123.83) x 4.75 (120.65)	4.88(123.83) x 7.75(196.85)	4.88 (123.83) x 7.75 (196.85)
Depth in (mm)	2.50 (63.50)	3.00 (76.20)	3.50 (88.90)	3.50 (88.90)	3.50 (88.90)



	8120	8081	8401	8096	1450
Style	Traditional Metal	Traditional Metal	Traditional Metal	Traditional Metal	360 Panel System
Total Positions	5 Positions	5 Positions	5 Positions	6 Positions	8 Positions
Circuit Breakers	5 A-Series, 15A (7210)	5 A-Series, 15A (7210)	5 A-Series, 15A (7210)	6 A-Series, 15A (7210)	8 Push Button, 15A (7056)
Nominal Voltage	12V DC	12V DC	12/24V DC	12/24V DC	12/24V DC
Maximum Amperage	50A	50A	100A	100A per bus	90A
DC Meter	--	8-16V (8028) , 0-50A (8041)	Digital Multimeter (8248)	--	--
Dual USB / Dash Socket	12/24V Dual USB 4.8 (1045) 12V Dash Socket (1011)	--	--	--	--
Width x Height in (mm)	5.25 (133.35) x 7.50 (190.50)	5.25 (133.35) x 7.50 (190.50)	5.25 (133.35) x 7.50 (190.50)	10.50 (266.70) x 3.75 (95.25)	4.88 (123.83) x 4.75 (120.65)
Depth in (mm)	2.50 (63.50)	2.50 (63.50)	4.00 (101.6)	2.50 (63.50)	3.50 (88.90)



	1498	1457	1456	1497
Style	360 Panel System	360 Panel System	360 Panel System	360 Panel System
Total Positions	8 Positions	8 Positions	8 Positions	8 Positions
Circuit Breakers	8 Push Button, 15A (7056)	8 Push Button, 10A (7054)	8 Push Button, 10A (7054)	8 A-Series, 15A (7403)
Rocker Switches	--	8 ON-OFF, SPST (7480)	8 ON-OFF, SPST (7480)	--
Dual USB / Dash Socket	12/24V Dual USB 4.8A (1045) 12V Dash Socket (1011)	--	--	12/24V Dual USB 4.8A (1045) 12V Dash Socket (1011)
Nominal Voltage	12V DC	12V DC	12V DC	12V DC
Maximum Amperage	90A	80A	80A	100A
DC Meter	--	--	--	M2 Multimeter w/SOC (1830)
Width x Height in (mm)	4.88(123.83) x 7.75(196.85)	4.88 (123.83) x 7.75 (196.85)	9.25 (234.95) x 4.75 (120.65)	9.25 (234.95) x 7.75 (196.85)
Depth in (mm)	3.50 (88.90)	3.50 (88.90)	3.50 (88.90)	4.00 (101.60)



	1200	1225	8023	8385	1463
Style	360 Panel System	360 Panel System	Traditional Metal	Traditional Metal	360 Panel System
Total Positions	8 Positions	8 Positions	8 Positions	8 Positions	8 Positions
Circuit Breakers	8 A-Series, 15A (7403)	8 A-Series, 15A (7403)	5 A-Series, 15A (7210)	6 A-Series, 15A (7210)	8 Push Button, 10A (7054)
Rocker Switches	--	--	--	--	8 ON-OFF, SPST (7480)
Nominal Voltage	12V DC	12V DC	12/24V DC	12/24V DC	12V DC
Maximum Amperage	100A	100A per bus	100A	100A per bus	80A
Meter (PN)	--	--	--	--	8-16V (8003)
Width x Height in (mm)	4.88 (123.83) x 7.75 (196.85)	9.25 (234.95) x 4.75 (120.65)	5.25 (133.35) x 7.50 (190.50)	10.50 (266.70) x 4.50 (114.30)	4.88 (123.83) x 10.75 (273.05)
Depth in (mm)	3.00 (76.20)	3.00 (76.20)	2.50 (63.50)	2.50 (63.50)	3.50 (88.90)



	1227	8082	8402	1461	1464
Style	360 Panel System	Traditional Metal	Traditional Metal	360 Panel System	360 Panel System
Total Positions	8 Positions	10 Positions	10 Positions	12 Positions	12 Positions
Circuit Breakers	8 A-Series, 15A (7403)	7 A-Series, 15A (7210)	7 A-Series, 15A (7210)	12 Push Button, 10A (7054)	12 Push Button, 10A (7054)
Rocker Switches	--	--	--	12 ON-OFF, SPST (7480)	12 ON-OFF, SPST (7480)
Nominal Voltage	12V DC	12V DC	12/24V DC	12V DC	12V DC
Maximum Amperage	100A	50A	100A	120A	120A
Meter	Digital Multimeter (8248)	8-16V (8028) / 0-50A (8041)	Digital Multimeter (8248)	--	8-16V (8003)
Width X Height in (mm)	4.88 (123.83) x 7.75 (196.85)	5.25 (133.35) x 11.25 (285.75)	5.25 (133.35) x 11.25 (285.75)	4.88 (123.83) x 10.75 (273.05)	9.25 (234.95) x 7.75 (196.85)
Depth in (mm)	3.00 (76.20)	2.50 (63.50)	4.00 (101.6)	3.50 (88.90)	3.50 (88.90)



	1223	1217	1496	8375
Style	360 Panel System	360 Panel System	360 Panel System	Traditional Metal
Total Positions	12 Positions	12 Positions	12 Positions	12 Positions
Circuit Breakers	12 A-Series, 15A (7403)	12 A-Series, 15A (7403)	12 A-Series, 15A (7403)	10 A-Series, 15A (7210)
Nominal Voltage	12V DC	12V DC	12/24V DC	12/24V DC
Maximum Amperage	100A	100A per bus	100A	100A per bus
DC Meter	--	Digital Multimeter (8248)	M2 Multimeter w/SOC (1830)	--
Width x Height in (mm)	4.88 (123.83) x 10.75 (273.05)	9.25 (234.95) x 7.75 (196.85)	9.25 (234.95) x 7.75 (196.85)	14.75 (374.65) x 4.50 (114.30)
Depth in (mm)	3.00 (76.20)	4.00 (101.60)	4.00 (101.60)	2.50 (63.50)

† Without ON-indicating LEDs or backlit label positions

DC Branch Circuit Breaker Panels



	8376	8068	8403
Style	Traditional Metal	Traditional Metal	Traditional Metal
Total Positions	13 Positions	13 Positions	13 Positions
Circuit Breakers	10 A-Series, 15A (7210)	10 A-Series, 15A (7210)	10 A-Series, 15A (7210)
Nominal Voltage	12/24V DC	12V DC	12/24V DC
Maximum Amperage	100A	50A	100A per bus
DC Meter	--	8-16V (8028) , 0-50A (8041)	Digital Multimeter (8248)
Width x Height in (mm)	5.25 (133.35) x 11.25 (285.75)	10.50 (266.70) x 7.50 (190.50)	10.50 (266.70) x 7.50 (190.50)
Depth in (mm)	2.50 (63.50)	3.00 (76.20)	4.00 (101.6)



	1222	8377	1201
Style	360 Panel System	Traditional Metal	360 Panel System
Total Positions	16 Positions	16 Positions	16 Positions
Circuit Breakers	16 A-Series, 15A (7403)	10 A-Series, 15A (7210)	16 A-Series, 15A (7403)
Nominal Voltage	12V DC	12/24V DC	12V DC
Maximum Amperage	100A per bus	100A per bus	50A
DC Meter	--	--	8-16V (8003) / 0-50A (8022)
Width in (mm)	9.25 (234.95)	10.50 (266.70)	13.63 (346.08)
Height in (mm)	7.75 (196.85)	7.50 (190.50)	7.75 (196.85)
Depth in (mm)	3.00 (76.20)	2.50 (63.50)	3.00 (76.20)



	8378	1221	8379
Style	Traditional Metal	360 Panel System	Traditional Metal
Total Positions	18 Positions	Main + 19 Positions	Main + 20 Positions
Circuit Breakers	15 A-Series, 15A (7210)	1 C-Series, 100A (7549) , 19 A-Series, 15A (7403)	1 C-Series, 100A (7250) , 14 A-Series, 15A (7210)
Nominal Voltage	12V DC	12V DC	12/24V DC
Maximum Amperage	100A	100A	100A
DC Meter	8-16V (8003) / 0-100A (8017)	Digital Multimeter (8248)	Digital Multimeter (8248)
Width in (mm)	14.75 (374.65)	13.63 (346.08)	14.75 (374.65)
Height in (mm)	7.50 (190.50)	7.75 (196.85)	7.50 (190.50)
Depth in (mm)	2.50 (63.50)	4.00 (101.60)	4.00 (101.6)



	8380	8264
Style	Traditional Metal	Traditional Metal
Total Positions	Main + 22 Positions	24 Positions
Circuit Breakers	1 C-Series, 100A (7250I) , 16 A-Series, 15A (7210)	15 A-Series, 15A (7210)
Nominal Voltage	12V DC	12/24V DC
Maximum Amperage	100A	100A per bus
DC Meter	8-16V (8028) / 0-100A Micro	--
Width in (mm)	10.50 (266.70)	14.75 (374.65)
Height in (mm)	11.25 (285.75)	7.50 (190.50)
Depth in (mm)	3.00 (76.20)	2.50 (63.50)



	8381	8382
Style	Traditional Metal	Traditional Metal
Total Positions	Main + 32 Positions	Main + 35 Positions
Circuit Breakers	1 C-Series, 100A (7250I) , 23 A-Series, 15A (7210)	1 C-Series, 100A (7250I) , 26 A-Series, 15A (7210)
Nominal Voltage	12V DC	12/24V DC
Maximum Amperage	100A	100A
DC Meter	8-16V (8003) / 0-100A (8017)	Digital Multimeter (8248)
Width in (mm)	14.75 (374.65)	14.75 (374.65)
Height in (mm)	11.25 (285.75)	11.25 (285.75)
Depth in (mm)	3.00 (76.20)	4.00 (101.6)

AC Main Circuit Breaker Panels EXPANDED OFFERING

Provides a path for delivering power from the AC source to the AC branch distribution system

Features

- Red reverse polarity indication LED
- Green ON indicating LEDs
- Backlit label positions

Component References

- A-Series Circuit Breakers (p. 84)
- AC Analog Meters (p. 143)
- AC Digital Multimeter (p. 149)
- Red reverse polarity indication LED (p. 155)
- Green ON indicating LEDs (p. 155)

- Traditional Metal Panels include 8031 label set (p. 156)
- 360 Panels include 4206 label set (p. 157)
- Source selection label set included with panels 8077, 8177, 8079, and 8179 (p. 157)
- M2 AC Multimeter (p. 144)

See page 88 for a discussion of ABYC ELCI recommendations for AC Main circuit protection.



	8077	8177	8079	8179	8029	8129	1214	1215
Style	Traditional Metal		Traditional Metal		Traditional Metal		360 Panel System	
Total Positions	Main Only		Main Only		Main + 1 position		Main + 2 positions	
A-Series Circuit Breakers	Main, 30A (7238)	Main, 16A (7294)	Main, 50A (7242)	Main, 32A (7295)	Main, 30A (7238)	Main, 16A (7294)	Main, 30A (7414) 2 Branch, 15A (7403)	Main, 16A (7412) 2 Branch, 8A (7401)
Nominal Voltage	120V AC	230V AC	120V AC	230V AC	120V AC	230V AC	120V AC	230V AC
Actuator Style	White Toggle		White Toggle		White Toggle		Flat Rocker	
Insulating Back Cover	--		--		4026 sold separately (p. 155)		1331 sold separately (p. 154)	
Width x Height in (mm)	2.63 (66.80) x 3.75 (95.25)		2.63 (66.80) x 3.75 (95.25)		5.25 (133.35) x 3.75 (95.25)		4.88 (123.83) x 4.75 (120.65)	
Depth in (mm)	2.50 (63.50)		2.50 (63.50)		2.50 (63.50)		3.00 (76.20)	



	1206	1207	8043	8143	8409	8509	8405	8505
Style	360 Panel System		Traditional Metal		Traditional Metal		Traditional Metal	
Total Positions	Main + 2 positions		Main + 3 positions		Main + 3 positions		Main + 3 positions	
A-Series Circuit Breakers	Main, 30A (7414) 2 Branch, 15A (7403)	Main, 16A (7412) 2 Branch, 8A (7401)	Main, 30A (7238) 3 Branch, 15A (7210)	Main, 16A (7294) 3 Branch, 8A (7299)	Main, 30A (7238) 3 Branch, 15A (7210)	Main, 16A (7294) 3 Branch, 8A (7299)	Main, 30A (7238) 3 Branch, 15A (7210)	Main, 16A (7294) 3 Branch, 8A (7299)
Nominal Voltage	120V AC	230V AC	120V AC	230V AC	120V AC	230V AC	120V AC	230V AC
Actuator Style	Flat Rocker		White Toggle		White Toggle		White Toggle	
AC Meter	0-150V (9353)	0-250V (8245)	0-150V (9353)	0-250V (8245)	0-150V (8244) 0-50A (8246)	0-250V (8245) 0-50A (8246)	Digital Multimeter (8247)	
Insulating Back Cover	2 x 1331 sold separately (p. 154)		4027 sold separately (p. 155)		4027 sold separately (p. 155)		4027 sold separately (p. 155)	
Width x Height in (mm)	4.88 (123.83) x 7.75 (196.85)		5.25 (133.35) x 7.50 (190.50)		5.25 (133.35) x 7.50 (190.50)		5.25 (133.35) x 7.50 (190.50)	
Depth in (mm)	3.00 (76.20)		2.50 (63.50)		3.00 (76.20)		4.00 (101.60)	



	8099	8199	8027	8127	8412	8512	1230	1233
Style	Traditional Metal		Traditional Metal		Traditional Metal		360 Panel System	
Total Positions	Main + 4 positions		Main + 6 positions		Main + 6 positions		Main + 6 positions	
A-Series Circuit Breakers	Main, 30A (7238) 4 Branch, 15A (7210)	Main, 16A (7294) 4 Branch, 8A (7299)	Main, 30A (7238) 3 Branch, 15A (7210)	Main, 16A (7294) 3 Branch, 8A (7299)	Main, 30A (7238) 4 Branch, 15A (7210)	Main, 16A (7294) 4 Branch, 8A (7299)	Main, 30A (7414) 6 Branch, 15A (7403)	Main, 16A (7412) 6 Branch, 8A (7401)
Nominal Voltage	120V AC	230V AC	120V AC	230V AC	120V AC	230V AC	120V AC	230V AC
Actuator Style	White Toggle		White Toggle		White Toggle		Flat Rocker	
Insulating Back Cover	--		4027 sold separately (p. 155)		--		2 x 1331 sold separately (p. 154)	
Width x Height in (mm)	10.50 (266.70) x 3.75 (95.25)		5.25 (133.35) x 7.50 (190.50)		10.50 (266.70) x 4.50 (114.30)		9.25 (234.95) x 4.75 (120.65)	
Depth in (mm)	2.50 (63.50)		2.50 (63.50)		2.50 (63.50)		3.00 (76.20)	

230 Volt (typical of Europe)



	1202	1203	1505	8074	8174	8488	8588	
Style	360 Panel System		360 Panel System		Traditional Metal		Traditional Metal	
Total Positions	Main + 6 positions		Main + 6 positions		Main + 8 positions		Main + 8 positions	
A-Series Circuit Breakers	Main, 30A (7414) 6 Branch, 15A (7403)	Main, 16A (7412) 6 Branch, 8A (7401)	Main, 30A (7414) 6 Branch, 15A (7403)		Main, 30A (7238) 5 Branch, 15A (7210)	Main, 16A (7294) 5 Branch, 8A (7299)	Main, 30A (7238) 5 Branch, 15A (7210)	Main, 16A (7294) 5 Branch, 8A (7299)
Nominal Voltage	120V AC 230V AC		120V AC		120V AC 230V AC		120V AC 230V AC	
Actuator Style	Flat Rocker		Flat Rocker		White Toggle		White Toggle	
AC Meter	--		M2 AC Multimeter (1838)		0-150V (8244) 0-50A (8246)	0-250V (8245) 0-50A (8246)	0-150V (9353)	0-250V (9354)
Insulating Back Cover	2 x 1331 sold separately (p. 150)		--		--		--	
Width x Height in (mm)	4.88 (123.83) x 7.75 (196.85)		4.88 (123.82) x 10.75 (273.05)		5.25 (133.35) x 11.25 (285.75)		5.25 (133.35) x 11.25 (285.75)	
Depth in (mm)	3.00 (76.20)		4.00 (101.60)		3.00 (76.20)		2.50 (63.50)	



	8406	8506	8485	8585	8076	8176
Style	Traditional Metal		Traditional Metal		Traditional Metal	
Total Positions	Main + 8 positions		Main + 11 positions		Main + 11 positions	
A-Series Circuit Breakers	Main, 30A (7238) 5 Branch, 15A (7210)	Main, 16A (7294) 5 Branch, 8A (7299)	Main, 30A (7238) 8 Branch, 15A (7210)	Main, 16A (7294) 8 Branch, 8A (7299)	Main, 30A (7238) 8 Branch, 15A (7210)	Main, 16A (7294) 8 Branch, 8A (7299)
Nominal Voltage	120V AC 230V AC		120V AC 230V AC		120V AC 230V AC	
Actuator Style	White Toggle		White Toggle		White Toggle	
AC Meter	Digital Multimeter (8247)		--		0-150V (8244) 0-50A (8246)	0-250V (8245) 0-50A (8246)
Insulating Back Cover	--		--		--	
Width x Height in (mm)	5.25 (133.35) x 11.25 (285.75)		5.25 (133.35) x 11.25 (285.75)		10.50 (266.70) x 7.50 (190.50)	
Depth in (mm)	4.00 (101.60)		2.50 (63.50)		3.00 (76.20)	



	8407	8507	8464	8564	8465	8565
Style	Traditional Metal		Traditional Metal		Traditional Metal	
Total Positions	Main + 11 positions		Main + 14 positions		Main + 22 positions	
A-Series Circuit Breakers	Main, 30A (7238) 8 Branch, 15A (7210)	Main, 16A (7294) 8 - Branch, 8A (7299)	Main, 30A (7238) 8 Branch, 15A (7210)	Main, 16A (7294) 8 Branch, 8A (7299)	Main, 30A (7238) 13 Branch, 15A (7210)	Main, 16A (7294) 13 Branch, 8A (7299)
Nominal Voltage	120V AC 230V AC		120V AC 230V AC		120V AC 230V AC	
Actuator Style	White Toggle		White Toggle		White Toggle	
AC Meter	Digital Multimeter (8247)		--		--	
Width x Height in (mm)	10.50 (266.70) x 7.50 (190.50)		10.50 (266.70) x 7.50 (190.50)		14.75 (374.65) x 7.50 (190.50)	
Depth in (mm)	4.00 (101.60)		2.50 (63.50)		2.50 (63.50)	

AC Branch Circuit Breaker Panels

Distributes current from high amperage inputs into lower amperage circuits

Features

- On indicating LEDs in all circuit positions
- Backlit label positions

Component References

- A-Series Circuit Breakers (p. 84)
- AC Analog Meters (p. 143)
- 360 Panels include 4206 label set (p. 157)
- Traditional Metal Panels include 8031 label set (p. 156)
- Green ON-indicating LEDs (p. 155)



	8058	8158	1210	1211	8097	8197
Style	Traditional Metal		360 Panel System		Traditional Metal	
Total Positions	3 Positions		4 Positions		6 Positions	
Circuit Breakers	3 A-Series, 15A (7210)	3 A-Series, 8A (7299)	4 A-Series, 15A (7403)	4 A-Series, 8A (7401)	6 A-Series, 15A (7210)	6 A-Series, 8A (7299)
Nominal Voltage	120V AC	230V AC	120V AC	230V AC	120V AC	230V AC
Maximum Amperage	100A		100A		100A per bus	
Actuator Style	White Toggle		Flat Rocker		White Toggle	
Insulating Back Cover	4026 sold separately (p. 155)		1331 sold separately (154)		--	
Width x Height in (mm)	5.25 (133.35) x 3.75 (95.25)		4.88 (123.83) x 4.75 (120.65)		10.50 (266.70) x 3.75 (95.25)	
Depth in (mm)	2.50 (63.50)		3.00 (76.20)		2.50 (63.50)	



	1228	1229	8059	8159
Style	360 Panel System		Traditional Metal	
Total Positions	8 Positions		8 Positions	
Circuit Breakers	8 A-Series, 15A (7403)	8 A-Series, 8A (7401)	5 A-Series, 15A (7210)	5 A-Series, 8A (7299)
Nominal Voltage	120V AC	230V AC	120V AC	230V AC
Maximum Amperage	100A		100A	
Actuator Style	Flat Rocker		White Toggle	
Insulating Back Cover	2 x 1331 sold separately (p. 154)		4027 sold separately (p. 155)	
Width x Height in (mm)	4.88 (123.83) x 7.75 (196.85)		5.25 (133.35) x 7.50 (190.50)	
Depth in (mm)	3.00 (76.20)		2.50 (63.50)	



	8411	8511	8478	8578	8480	8580
Style	Traditional Metal		Traditional Metal		Traditional Metal	
Total Positions	8 Positions		10 Positions		13 Positions	
Circuit Breakers	6 A-Series, 15A (7210)	6 A-Series, 8A (7299)	7 A-Series, 15A (7210)	7 A-Series, 8A (7299)	10 A-Series, 15A (7210)	10 A-Series, 8A (7299)
Nominal Voltage	120V AC	230V AC	120V AC	230V AC	120V AC	230V AC
Maximum Amperage	100A per bus		100A		100A	
Actuator Style	White Toggle		White Toggle		White Toggle	
Meter (PN)	--		0-150V (9353)	0-250V (9354)	--	
Insulating Back Cover	--		--		--	
Width x Height in (mm)	10.50 (266.70) x 4.50 (114.30)		5.25 (133.35) x 11.25 (285.75)		5.25 (133.35) x 11.25 (285.75)	
Depth in (mm)	2.50 (63.50)		2.50 (63.50)		2.50 (63.50)	

230 Volt (typical of Europe)



	8479		8561		8165	
Style	Traditional Metal		Traditional Metal		Traditional Metal	
Total Positions	13 Positions		16 Positions		24 Positions	
Circuit Breakers	10 A-Series, 15A (7210)	10 A-Series, 8A (7299)	10 A-Series, 15A (7210)	10 A-Series, 8A (7299)	15 A-Series, 15A (7210)	15 A-Series, 8A (7299)
Nominal Voltage	120V AC	230V AC	120V AC	230V AC	120V AC	230V AC
Maximum Amperage	100A per bus		100A per bus		100A per bus	
AC Meter	0-150V (9353)	0-250V (9354)	--		--	
Actuator Style	White Toggle		White Toggle		White Toggle	
Insulating Back Cover	--		--		--	
Width in (mm)	10.50 (266.70) x 7.50 (190.50)		10.50 (266.70) x 7.50 (190.50)		14.75 (374.64) x 7.50 (190.50)	
Depth in (mm)	2.50 (63.50)		2.50 (63.50)		2.50 (63.50)	

230 Volt (typical of Europe)

AC 120/240 Volt (60Hz) Circuit Breaker Panels

Provides circuit protection for 240V AC systems

- 1168 Provides 1 spare rocker aperture
- C-Series Circuit Breakers (p. 80)



	7372	1168
Style	Traditional Metal	360 Panel System
Total Positions	Main Only	Main + 1 position
C-Series Circuit Breaker	1 Main, 50A (7287)	1 Main, 50A (7565)
Poles	3	3
Nominal Voltage	120/240V	120/240V
Maximum Voltage	240V AC	240V AC
Actuator Style	White Toggle	Flat Rocker
Width in (mm)	5.25 (133.35)	4.88 (123.83)
Height in (mm)	3.75 (95.25)	4.75 (120.65)
Depth in (mm)	3.00 (76.20)	3.00 (76.20)

AC Residual Current Circuit Breaker Panels

EXPANDED OFFERING

Reduces the risk of fire and shock hazards caused by defects in appliances and circuit wiring

Features

- Provides Main circuit protection with branch circuits

Component References

- ELCI Main Circuit Breakers (p. 89)
- A-Series Circuit Breakers (p. 84)
- AC Analog Meters (p. 143)
- M2 AC Multimeter (p. 144)

See page 88 for a discussion of ABYC ELCI recommendations for AC Main circuit protection.



	1502	8100	1190	8101
Style	360 Panel System	Traditional Metal	360 Panel System	Traditional Metal
Total Positions	ELCI + 1 Position	ELCI	ELCI + 1 position	ELCI + 5 positions
GFCI/ELCI Circuit Breaker	1 - ELCI Main, 30A (3102)	1 - ELCI Main, 30A (3106)	1 - ELCI Main, 30A (3102)	1 - ELCI Main, 30A (3106)
A-Series Circuit Breaker	--	--	1 - Branch, 15A AC (7403)	2 - Branch, 15A (7210)
Amperage Trip Reference	30A	30A	30A	30A
Leakage Trip Amperage	30mA	30mA	30mA	30mA
Maximum Voltage	120V	120V	120V	120V
Actuator Style	Flat Rocker	White Toggle	Flat Rocker	White Toggle
Insulating Panel Back	1331 sold separately (p. 154)	--	1331 sold separately (p. 154)	--
Width x Height in (mm)	4.88 (123.83) x 4.75 (120.65)	5.25 (133.35) x 3.75 (95.25)	4.88 (123.83) x 4.75 (120.65)	5.25 (133.35) x 7.50 (190.50)
Depth in (mm)	3.99 (101.4)	3.50 (88.90)	3.99 (101.4)	3.50 (88.90)



	8102	1193	1503	1504
Style	Traditional Metal	360 Panel System	360 Panel System	360 Panel System
Total Positions	ELCI + 2 positions	ELCI + 5 positions	ELCI + 5 positions	ELCI + 5 positions
ELCI Circuit Breaker	1 - ELCI Main, 30A AC (3106)	1 - ELCI Main, 30A AC (3102)	1 - ELCI Main, 30A AC (3102)	1 - ELCI Main, 30A AC (3102)
A-Series Circuit Breaker	2 - Branch, 15A AC (7210)	4 - Branch, 15A AC (7403)	5 - Branch, 15A AC (7403)	5 - Branch, 15A AC (7403)
Amperage Trip Reference	30A AC	30A AC	30A AC	30A AC
Leakage Trip Amperage	30mA	30mA	30mA	30mA
Maximum Voltage	120V AC	120V AC	120V AC	120V AC
Actuator Style	White Toggle	Flat Rocker	Flat Rocker	Flat Rocker
Insulating Panel Back	-	2 x 1331 sold separately (p. 154)	2 x 1331 sold separately (p. 154)	2 x 1331 sold separately (p. 154)
AC Meter	0-150V (9353)	-	-	M2 AC Multimeter (1838)
Width x Height in (mm)	5.25 (133.35) x 7.50 (190.50)	9.25 (234.95) x 4.75 (120.65)	4.88(123.83) x 7.75(196.85)	4.88 (123.83) x 10.75 (273.05)
Depth in (mm)	3.50 (88.9)	3.99 (101.4)	3.99 (101.40)	3.99 (101.40)

AC Source Selection Circuit Breaker Panels

Allows selecting between multiple AC sources to supply power to the AC branch distribution system

Features

- Lockout slides ensure that no two sources of AC power are connected to the circuit simultaneously
- Backlit label positions

Component References

- A-Series Circuit Breakers (p. 84)
- AC Analog Meters (p. 143)
- AC Digital Multimeter (p. 149)
- Red reverse polarity indication LED (p. 155)
- Green ON indicating LEDs (p. 155)
- Traditional Metal Panels with branch circuit breakers include 8031 label set (p. 156)
- 360 Panels with branch circuit breakers include 4206 label set (p. 157)
- All panels include a reverse polarity label and a source selection label set (p. 157)



	1208	1209	1231	1232	8032	8132	8061	8161
Style	360 Panel System		360 Panel System		Traditional Metal		Traditional Metal	
Total Positions	2 Sources		2 Sources		2 Sources		2 Sources	
A-Series Circuit Breakers	2 Main, 30A (7574)	2 Main, 16A (7572)	2 Main, 50A (7577)	2 Main, 32A (7575)	2 Main, 30A (7238)	2 Main, 16A (7294)	2 Main, 50A (7242)	2 Main, 32A (7295)
Nominal Voltage	120V AC	230V AC	120V AC	230V AC	120V AC	230V AC	120V AC	230V AC
Actuator Style	Raised Rocker		Raised Rocker		White Toggle		White Toggle	
Insulating Back Cover	1331 sold separately (p. 154)		1331 sold separately (p. 154)		4026 sold separately (p. 154)		4026 sold separately (p. 154)	
Width x Height in (mm)	4.88 (123.83) x 4.75 (120.65)		4.88 (123.83) x 4.75 (120.65)		5.25 (133.35) x 3.00 (76.20)		5.25 (133.35) x 3.00 (76.20)	
Depth in (mm)	3.00 (76.20)		3.00 (76.20)		3.00 (76.20)		3.00 (76.20)	



	8498	8598	8499	8599	8467	8567
Style	Traditional Metal		Traditional Metal		Traditional Metal	
Total Positions	3 Sources + Transfer		2 Sources + 4 positions		2 Sources + 4 positions	
A-Series Circuit Breakers (Part #)	2 Main, 30A (7238) 1 Main, 50A (7242) 1 Transfer, 30A (7238)	2 Main, 16A (7294) 1 Main, 32A (7295) 1 Transfer, 16A (7294)	2 Main, 30A (7238) 2 Branch, 15A (7210)	2 Main, 16A (7294) 2 Branch, 8A (7299)	2 Main, 30A (7238) 2 Branch, 15A (7210)	2 Main, 16A (7294) 2 Branch, 8A (7299)
Nominal Voltage	120V AC	230V AC	120V AC	230V AC	120V AC	230V AC
Actuator Style	White Toggle		White Toggle		White Toggle	
Insulating Back Cover	--		--		4027 sold separately (p. 151)	
Width x Height in (mm)	10.50 (266.70) x 4.50 (114.30)		10.50 (266.70) x 4.50 (114.30)		5.25 (133.35) x 7.50 (190.50)	
Depth in (mm)	3.00 (76.20)		3.00 (76.20)		3.00 (76.20)	



	8489	8589	8462	8562	8466	8566
Style	Traditional Metal		Traditional Metal		Traditional Metal	
Total Positions	2 Sources + 6 positions		2 Sources + 9 positions		2 Sources + 9 positions	
A-Series Circuit Breakers	2 Main, 30A (7238) 3 Branch, 15A (7210)	2 Main, 16A (7294) 3 Branch, 8A (7299)	2 Main, 30A (7238) 6 Branch, 15A (7210)	2 Main, 16A (7294) 6 Branch, 8A (7299)	2 Main, 30A (7238) 6 Branch, 15A (7210)	2 Main, 16A (7294) 6 Branch, 8A (7299)
Nominal Voltage	120V AC	230V AC	120V AC	230V AC	120V AC	230V AC
Actuator Style	White Toggle		White Toggle		White Toggle	
Meter	0-150V (9353)	0-250V (9354)	0-150V (9353)	0-250V (9354)	--	
Insulating Back Cover	--		--		--	
Width x Height in (mm)	5.25 (133.35) x 11.25 (285.75)		10.50 (266.70) x 7.50 (190.50)		5.25 (133.35) x 11.25 (285.75)	
Depth in (mm)	3.00 (76.20)		3.00 (76.20)		3.00 (76.20)	

AC Source Selection Rotary Switch Panels

Provides a solution for managing AC sources when circuit protection is provided elsewhere

- Panels include green ON and red Reverse Polarity indicating LEDs and source selection label set (p.157)
- 360 Panel System panels include backlit label positions

30 Amp 2 Positions + OFF, 2 Pole Rotary Switch

- Switches 2 sources
- Allows connecting one of two different AC sources to one circuit

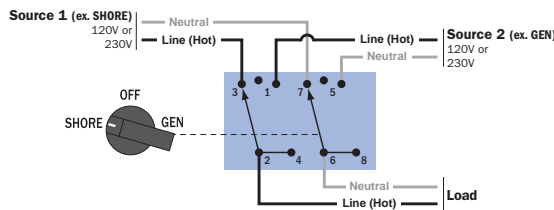

Regulatory
CE marked
UL listed



	9009	1481	1484	8367	8359
Style	Rotary Switch	360 Panel System	360 Panel System	Traditional Metal	Traditional Metal
Voltage Max. Operating	600V AC	120V AC	230V AC	120V AC	230V AC
Wire Size Range	14-10 AWG	14-10 AWG	14-10 AWG	14-10 AWG	14-10 AWG
Insulating Panel Back	-	1331 sold separately (p. 154)	1331 sold separately (p. 154)	4026 sold separately (p. 155)	4026 sold separately (p. 155)
Width x Height in (mm)	1.89 (48.00) x 1.89 (48.00)	4.88 (123.83) x 4.75 (120.65)	4.88 (123.83) x 4.75 (120.65)	5.25 (133.35) x 3.75 (95.25)	5.25 (133.35) x 3.75 (95.25)
Depth in (mm)	1.91 (48.51)	1.91 (48.51)	1.91 (48.51)	1.91 (48.51)	1.91 (48.51)

65 Amp 2 Positions + OFF, 2 Pole Rotary Switch

- Switches 2 sources
- Allows connecting one of two different AC sources to one circuit

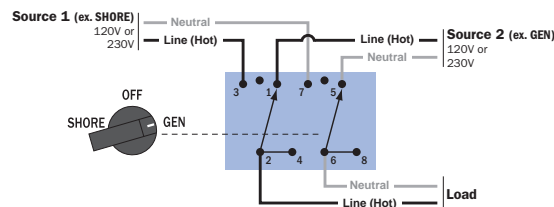

Regulatory
CE marked
UL listed



	9011	1483	1486	8365	8357
Style	Rotary Switch	360 Panel System	360 Panel System	Traditional Metal	Traditional Metal
Voltage Max. Operating	600V AC	120V AC	230V AC	120V AC	230V AC
Wire Size Range	12-6 AWG	12-6 AWG	12-6 AWG	12-6 AWG	12-6 AWG
Insulating Panel Back	-	1331 sold separately (p. 154)	1331 sold separately (p. 154)	4026 sold separately (p. 155)	4026 sold separately (p. 155)
Width x Height in (mm)	2.52 (64.00) x 2.52 (64.00)	4.88 (123.83) x 4.75 (120.65)	4.88 (123.83) x 4.75 (120.65)	5.25 (133.35) x 3.75 (95.25)	5.25 (133.35) x 3.75 (95.25)
Depth in (mm)	2.41 (61.21)	2.41 (61.21)	2.41 (61.21)	2.41 (61.21)	2.41 (61.21)

30 Amp 3 Positions + OFF, 2 Pole Rotary switch

- Switches 3 sources
- Allows connecting one of three different AC sources to one circuit

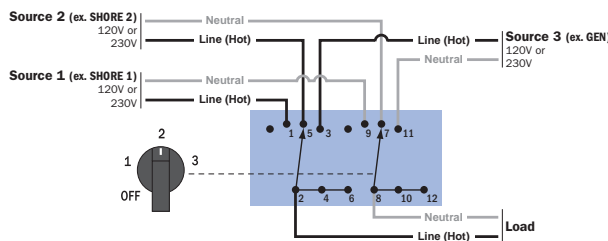

Regulatory
CE marked
UL listed



	9010	1482	1485	8366	8358
Style	Rotary Switch	360 Panel System	360 Panel System	Traditional Metal	Traditional Metal
Voltage Max. Operating	600V AC	120V AC	230V AC	120V AC	230V AC
Wire Size Range	14-10 AWG	14-10 AWG	14-10 AWG	14-10 AWG	14-10 AWG
Insulating Panel Back	-	1331 sold separately (p. 154)	1331 sold separately (p. 154)	4026 sold separately (p. 155)	4026 sold separately (p. 155)
Width x Height in (mm)	1.89 (48.00) x 1.89 (48.00)	4.88 (123.83) x 4.75 (120.65)	4.88 (123.83) x 4.75 (120.65)	5.25 (133.35) x 3.75 (95.25)	5.25 (133.35) x 3.75 (95.25)
Depth in (mm)	2.41 (61.21)	2.41 (61.21)	2.41 (61.21)	2.41 (61.21)	2.41 (61.21)

65 Amp 2 Positions + OFF, 3 Pole Rotary Switch

- Allows connecting one of two different AC sources to one circuit
- Switches 2-120/240 Volt AC sources
- Switches both lines (hots) and neutral

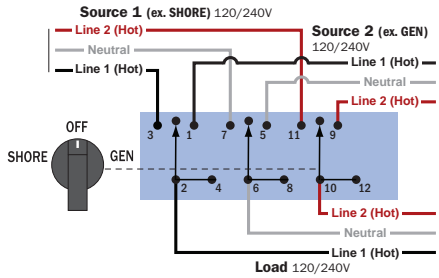

Regulatory
CE marked
UL listed



	9019	1487	8363
Style	Rotary Switch	360 Panel System	Traditional Metal
Voltage Max. Operating	600V AC	240V AC	240V AC
Wire Size Range	12-6 AWG	12-6 AWG	12-6 AWG
Insulating Panel Back	--	--	--
Width x Height in (mm)	2.52 (64.00) x 2.52 (64.00)	4.88 (123.83) x 4.75 (120.65)	5.25 (133.35) x 3.75 (95.25)
Depth in (mm)	3.65 (92.71)	3.65 (92.71)	3.65 (92.71)

30 Amp 2 Positions + OFF, 4 Pole Rotary Switch

- Switches between 2-120 Volt AC shore power sources and 1-120/240 Volt AC source to 2-120 Volt AC load groups
- Switches both lines (hots) and neutral

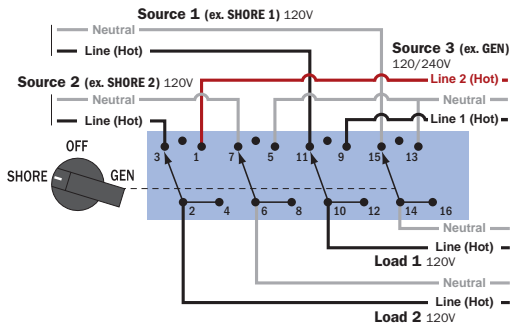

Regulatory
CE marked
UL listed



	6337	1489	8386
Style	Rotary Switch	360 Panel System	Traditional Metal
Voltage Max. Operating	600V AC	240V AC	240V AC
Wire Size Range	14-10 AWG	14-10 AWG	14-10 AWG
Insulating Panel Back	-	1331 sold separately (p. 154)	-
Width x Height in (mm)	1.89 (48.00) x 1.89 (48.00)	4.88 (123.83) x 4.75 (120.65)	5.25 (133.35) x 3.75 (95.25)
Depth in (mm)	2.98 (75.69)	2.98 (75.69)	2.98 (75.69)

65 Amp 2 Positions + OFF, 4 Pole Rotary Switch

- Switches between 2-120 Volt AC shore power sources and 1-120/240 Volt AC source to 2-120 Volt AC load groups
- Switches both lines (hots) and neutral

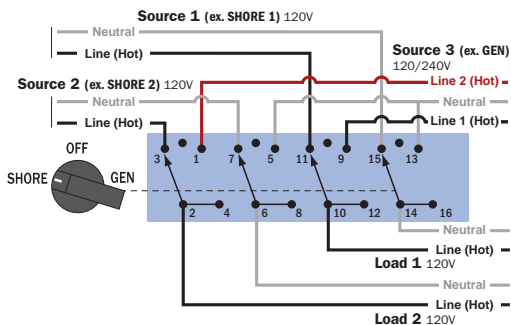

Regulatory
CE marked
UL listed



	9093	1480	8369
Style	Rotary Switch	360 Panel System	Traditional Metal
Voltage Max. Operating	600V AC	240V AC	240V AC
Wire Size Range	12-6 AWG	12-6 AWG	12-6 AWG
Insulating Panel Back	--	--	--
Width x Height in (mm)	2.52 (64.00) x 2.52 (64.00)	4.88 (123.83) x 4.75 (120.65)	5.25 (133.35) x 3.75 (95.25)
Depth in (mm)	4.50 (114.30)	4.50 (114.30)	4.50 (114.30)

65 Amp 3 Positions + OFF, 3 Pole Rotary Switch

- Allows connecting one of three different AC sources to one circuit
- Switches 3-120/240 Volt AC sources
- Switches both lines (hot) and neutral

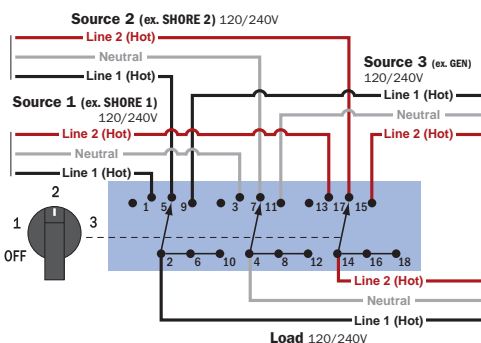

Regulatory
CE marked
UL listed



	9077	1488	8361
Style	Rotary Switch	360 Panel System	Traditional Metal
Voltage Max. Operating	600V AC	240V AC	240V AC
Wire Size Range	12-6 AWG	12-6 AWG	12-6 AWG
Insulating Panel Back	--	--	--
Width x Height in (mm)	2.52 (64.0) x 2.52 (64.0)	4.88 (123.83) x 4.75 (120.65)	5.25 (133.35) x 3.75 (95.25)
Depth in (mm)	5.50 (139.70)	5.50 (139.70)	5.50 (139.70)

AC/DC Combination Circuit Breaker Panels

Combines AC and DC switching, circuit protection, source selection and monitoring into a single panel

EXPANDED OFFERING

Features

- ON indicating LEDs installed in all circuit positions
- Backlit label positions
- Includes toggle switch to monitor voltage on up to three batteries
- Circuit identification label sets included
- Insulating covers are included with AC/DC 360 Panels

Component References

- A-Series Circuit Breakers (p. 84)
- C-Series Circuit Breakers (p. 86)
- DC and AC Analog Meters (p. 142, 143)
- DC and AC Digital Multimeters (p. 148, 149) M2 Vessel System Monitor (VSM) (p. 146)
- 360 Panel System AC Insulating Rear Covers (p. 154)
- Traditional Metal Panel AC insulating Rear Covers (p. 155)
- Traditional Metal Panels include 8031 and 8030 label set (p. 156-157)
- 360 Panels include 4206 and 4205 label set (p. 157)



	8084	8184	8095	8195
Style	Traditional Metal		Traditional Metal	
Total AC Positions	Main + 6 positions		Main + 8 positions	
Total DC Positions	Main + 15 positions		Main + 29 positions	
AC Circuit Breakers	Main, 30A (7238) 3 Branch, 15A (7210)	Main, 16A (7294) 3 Branch, 8A (7299)	Main, 30A (7238) 5 Branch, 15A (7210)	Main, 16A (7294) 5 Branch, 8A (7299)
DC Circuit Breakers	Main, 100A (7250I) 9 Branch, 15A (7210)	Main, 100A (7250I) 9 Branch, 15A (7210)	Main, 100A DC (7250I) 20 Branch, 15A DC (7210)	Main, 100A (7250I) 20 Branch, 15A (7210)
AC/DC Voltage	120V AC/12V DC		230V AC/12V DC	
Insulating Panel Back	4029 sold separately (p. 155)		-	
Actuator Style	White Toggle			
AC Meters	0-150V AC (9353)		0-150V AC (9353), 0-50A AC (9630)	0-250V AC (9354), 0-50A AC (9630)
DC Meters	8-16V DC (8003), 0-100A DC (8017)		8-16V DC (8003), 0-100A DC (8017)	
Width x Height in (mm)	14.75 (374.65) x 10.00 (254.00)		19.50 (495.30) x 11.50 (292.10)	
Depth in (mm)	3.00 (76.20)		3.00 (76.20)	



230 Volt (typical of Europe)

	1218	1219	8413
Style	360 Panel System		Traditional Metal
Total AC Positions	Main + 6 positions		Main + 8 positions
Total DC Positions	Main + 19 positions		Main + 14 positions
AC Circuit Breakers	Main, 30A (7414) 6 Branch, 15A (7403)	Main, 16A (7412) 6 Branch, 8A (7401)	Main, 30A (7238) 8 Branch, 15A (7210)
DC Circuit Breakers	Main, 100A (7549) 19 Branch, 15A (7403)	Main, 100A (7549) 19 Branch, 15A (7403)	Main, 100A DC (7250I) 14 Branch, 15A (7210)
AC/DC Voltage	120V AC/12V DC		120V AC/12/24V DC
Insulating Panel Back	1331 Included with panel (p. 154)		-
Actuator Style	Flat Rocker		White Toggle
AC Meter, DC Meter	Digital Multimeter (8247), Digital Multimeter (8248)		M2 VSM (1850)
Width x Height in (mm)	13.63 (346.08) x 10.75 (273.05)		15.77 (400.50) x 9.25 (234.95)
Depth in (mm)	3.00 (76.20)		3.00 (76.20)



	8408	8508	8086	8186
Style	Traditional Metal		Traditional Metal	
Total AC Positions	Main + 6 positions		3 Sources + 12 positions + Transfer	
Total DC Positions	Main + 18 positions		Main + 19 positions	
AC Circuit Breakers	Main, 30A (7238) 3 Branch, 15A (7210)	Main, 16A (7294) 3 Branch, 8A (7299)	2 Main, 30A (7238) 1 Main, 50A (7242) 1 Transfer, 30A (7238) 6 Branch, 15A (7210)	2 Main, 16A (7294) 1 Main, 32A (7295) 1 Transfer, 16A (7294) 6 Branch, 8A (7299)
DC Circuit Breakers	Main, 100A (7250I) 12 Branch, 15A (7210)	Main, 100A (7250I) 12 Branch, 15A (7210)	Main, 100A (7250I) 13 Branch, 15A (7210)	
AC/DC Voltage	120V AC/12/24V DC	230V AC/12/24V DC	120V AC/12V DC	230V AC/12V DC
Insulating Panel Back	4029 sold separately (p. 155)		4031 sold separately (p. 155)	
Actuator Style	White Toggle		White Toggle	
AC Meters	Digital Multimeter (8247)		0-150V (9353), 0-50A (9630)	0-250V (9354), 0-50A (9630)
DC Meters	Digital Multimeter (8248)		8-16V (8003), 0-100A (8017)	
Width x Height in (mm)	15.75 (400.05) x 10.00 (254.00)		19.50 (495.30) x 11.50 (292.10)	
Depth in (mm)	4.00 (101.60)		3.00 (76.20)	



Vicem Yachts builds the Windsor Craft 38 Hardtop and specifies Blue Sea Systems products, including Traditional Metal Panels, to control power distribution at the helm.

Design and Order a Custom Panel in Three Easy Steps

Design and Order custom panels online

A Custom 360 Panel can be created in a fraction of the time required by other custom panel shops. The 360 Panel System uses an open frame to mount a broad selection of modules, allowing multiple functions to be combined in a single panel. This innovative design offers a wide choice of AC and DC panel features, can accommodate future changes, and permits rapid assembly. With options ranging from battery management to source selection, the 360 Panel System provides a wide range of design flexibility.



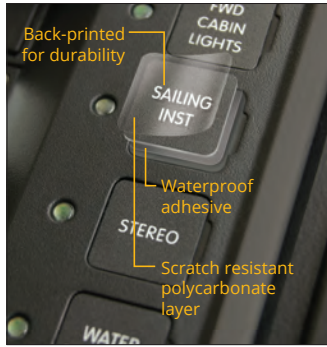

Blue Sea Systems labels are made using a scratch resistant polycarbonate material and are back-printed for durability. Custom Labels for the 360 Panel System can be ordered in any language and are available directly from Blue Sea Systems along with over 500 standard or square format labels.

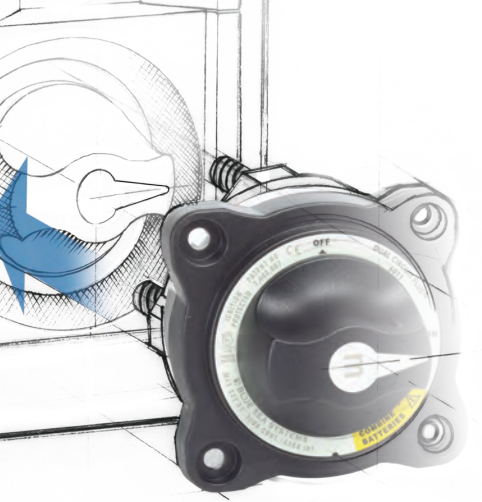

1

Launch
the Panel Wizard at panelwizard.blusea.com.

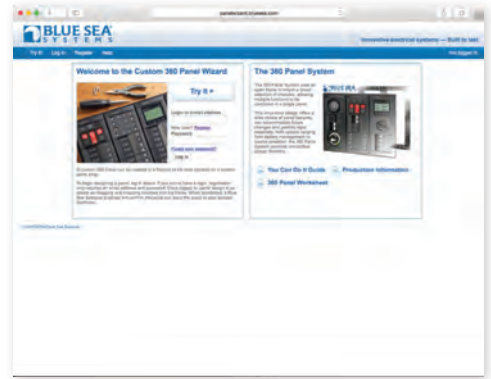

2

Design
the panel with modules, circuit breakers, and labels. The list price is updated with each change.



3

Save
the panel design and request a quote. Panels ship within ten business days of order receipt.



Completed 3 x 3 Panel



Custom 360 Panel System

Flexible frame and module configurations from a single module to a 25 module panel with 100 circuit breakers.

EXPANDED OFFERING

Rows x Columns	Height in (mm)	Width in (mm)	Cut out Height in (mm)	Cut out Width in (mm)
1 x 1	4.75 (120.65)	4.88 (123.83)	3.31 (84.07)	4.38 (111.13)
2 x 1	7.75 (196.85)	4.88 (123.83)	6.31 (160.27)	4.38 (111.13)
3 x 1	10.75 (273.05)	4.88 (123.83)	9.31 (236.47)	4.38 (111.13)
4 x 1	13.75 (349.25)	4.88 (123.83)	12.31 (312.67)	4.38 (111.13)
5 x 1	16.75 (425.45)	4.88 (123.83)	15.31 (388.87)	4.38 (111.13)
1 x 2	4.75 (120.65)	9.25 (234.95)	3.31 (84.07)	8.75 (222.25)
2 x 2	7.75 (196.85)	9.25 (234.95)	6.31 (160.27)	8.75 (222.25)
3 x 2	10.75 (273.05)	9.25 (234.95)	9.31 (236.47)	8.75 (222.25)
4 x 2	13.75 (349.25)	9.25 (234.95)	12.31 (312.67)	8.75 (222.25)
5 x 2	16.75 (425.45)	9.25 (234.95)	15.31 (388.87)	8.75 (222.25)
1 x 3	4.75 (120.65)	13.63 (346.08)	3.31 (84.07)	13.13 (333.38)
2 x 3	7.75 (196.85)	13.63 (346.08)	6.31 (160.27)	13.13 (333.38)
3 x 3	10.75 (273.05)	13.63 (346.08)	9.31 (236.47)	13.13 (333.38)
4 x 3	13.75 (349.25)	13.63 (346.08)	12.31 (312.67)	13.13 (333.38)
5 x 3	16.75 (425.45)	13.63 (346.08)	15.31 (388.87)	13.13 (333.38)
1 x 4	4.75 (120.65)	18.00 (457.20)	3.31 (84.07)	17.50 (444.50)
2 x 4	7.75 (196.85)	18.00 (457.20)	6.31 (160.27)	17.50 (444.50)
3 x 4	10.75 (273.05)	18.00 (457.20)	9.31 (236.47)	17.50 (444.50)
4 x 4	13.75 (349.25)	18.00 (457.20)	12.31 (312.67)	17.50 (444.50)
5 x 4	16.75 (425.45)	18.00 (457.20)	15.31 (388.87)	17.50 (444.50)
1 x 5	4.75 (120.65)	22.38 (568.33)	3.31 (84.07)	21.88 (555.63)
2 x 5	7.75 (196.85)	22.38 (568.33)	6.31 (160.27)	21.88 (555.63)
3 x 5	10.75 (273.05)	22.38 (568.33)	9.31 (236.47)	21.88 (555.63)
4 x 5	13.75 (349.25)	22.38 (568.33)	12.31 (312.67)	21.88 (555.63)
5 x 5	16.75 (425.45)	22.38 (568.33)	15.31 (388.87)	21.88 (555.63)



m-Series Battery Switch (p. 132)



m-ACR Automatic Charging Relay (p. 48)



m-LVD Low Voltage Disconnect (p. 42)

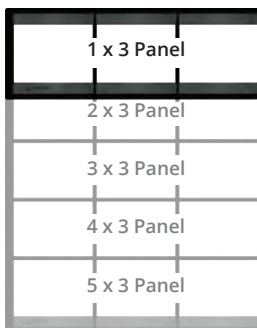
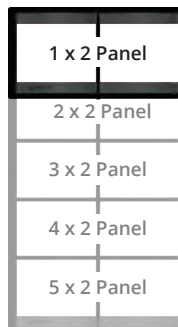

Battery Management (p. 96)

Custom BusBar Modules **NEW**

Consolidate bussed terminations in a 360 Custom Panel module

- Utilize blank space in a 360 Custom Panel frame
- Ideal for DC negative, AC Neutral, and AC Ground connections
- 5 different bus bar configuration options

Panel Backs Shown Below



2x1 Panel 2722



2x1 Panel 2702



2x1 Panel 2301



2x1 Panel 2128



2x1 Panel 2701

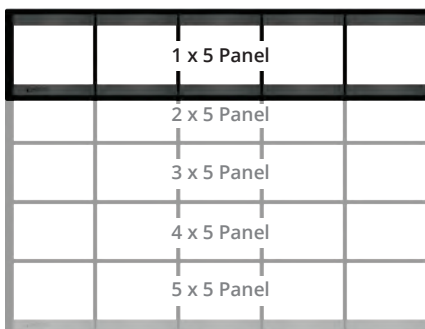
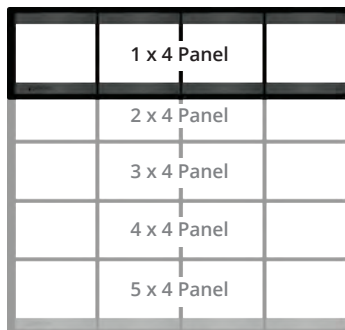

Battery Management Blank



DC Flat Rocker Circuit Breaker (p. 85)



Rotary Switch Source Selection (p. 130)

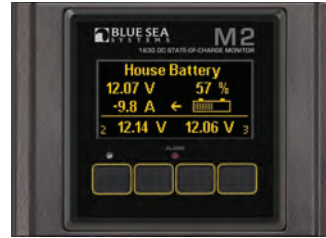

M2 OLED Meter (p. 144)



Mastervolt Smart Remote



COTS Circuit Breaker (p. 82)



Circuit Breaker Source Selection



Digital Meter (p. 148)



2 Inch Gauge Blank (p. 151)



Push Button Circuit Breaker with Rocker Switch (p. 77, 96)



Residual Current Circuit Breaker (p. 89)



P12 Battery Charger Display (p. 22)



Socket, Dual USB Charger (p. 26, 27)



Push Button Circuit Breaker (p. 77)



European RCBO Mount



Analog Meter (p. 142)



DC Accessories (p. 26, 27, 147)



Bilge Pump



Medium Duty Push Button Circuit Breaker (p. 78)



120V AC Dual GFCI Outlet (p. 154)



120V AC Dual Outlet (p. 154)



AC Flat Rocker Circuit Breaker (p. 85)



285 Series Circuit Breaker (p. 80)



Blank / Custom BusBar Module



120V AC Dual Outlet Blank

Not all 360 Panel modules or configurations shown, reference the Blue Sea Systems Panel Wizard at <https://panelwizard.blueseas.com>

Custom 360 Panel System

Original equipment aboard the world's finest boats and specialty vehicles

Blue Sea Systems Custom 360 Panels are installed as original equipment aboard recreational and commercial boats, emergency response vehicles, and commercial applications.



Sabre Yachts installs Custom 360 Panels at the helm of their Maine-built boats, including the flagship 54 Flybridge Sedan.



EarthRoamer builds vehicles which can go beyond where the road ends. They rely on Blue Sea Systems electrical products, including the Custom 360 Panel, to keep their critical systems functioning.



Moose Boats builds rugged aluminum boats for government and recreational use and specifies 360 Panels as original equipment.





C & C Yachts builds high performance sailboats and uses Custom 360 Panels to manage and monitor the AC and DC Power Distribution aboard the Redline 41.



MJM Yachts builds boats which use Blue Sea Systems products including Custom 360 Panels aboard the 36Z.



Robertson and Caine of South Africa uses Blue Sea Systems Custom 360 Panels as original equipment on their versatile catamarans, including the Leopard 48, used in charter fleets around the world.

METERS

Analog

142



AC and DC Meters with backlighting for low light conditions.

M2 OLED Digital

144



Measures essential electrical system parameters with adjustable alarms and an auto-dimming display.

Digital

148



Monitors key AC and DC functions.

Mini OLED Digital

147



Monitors key functions on a bright, waterproof, daylight readable screen.



Direct Current (DC) Monitoring

Direct Current is typically derived from batteries, but can also be produced by converting AC Current to DC Current using a battery charger. Typically the values measured are Volts, Amps and Amp-Hours (State-of-Charge).

METERS

Mini Clamp Multimeter

147



Compact and feature-rich AC/DC Multimeter simplifies diagnosis of marine electrical problems.

DC Shunts

151



For use with DC Ammeters.

Temperature Sensors

151



For use with the M2 OLED and Mini OLED Meters.

AC Transformers

151



For use with AC Ammeters.



Alternating Current (AC) Monitoring

Alternating Current, known more typically as household current, can also be produced by converting DC current to AC current through the use of an inverter. Typically the values measured are Volts, Amps, Watts, and Frequency.

DC Analog Meters

Meters with backlighting for low light conditions

- Includes appropriate external DC shunt (p. 136) when required
- Backlit meter face (separate 12 or 24V DC backlight connections)



8028



8003

Part #	Function	Operating Amps (Meter)	Operating Amps (Backlight)	Connection
8028	Micro Voltmeter 8-16V DC	1 mA at full scale	16 mA@12V DC, 20 mA@24V DC	2 wire, 3 connections for backlight
8003	Standard Voltmeter 8-16V DC	1 mA at full scale	16 mA@12V DC, 20 mA@24V DC	2 wire, 3 connections for backlight
8240	Standard Voltmeter 18-32V DC	1 mA at full scale	16 mA@12V DC, 20 mA@24V DC	2 wire, 3 connections for backlight



8041



8005

Part #	Function	Operating Amps (Meter)	Operating Amps (Backlight)	Shunt Type	Connection
8041	Micro Ammeter 0-50A DC	1 mA at full scale	16 mA@12V DC, 20 mA@24V DC	External—50 mV at meter full scale	2 wire from shunt, 3 connections for backlight
8005	Standard Ammeter 0-25A DC	1 mA at full scale	16 mA@12V DC, 20 mA@24V DC	Internal	2 wire inline, 3 connections for backlight
8022	Standard Ammeter 0-50A DC	1 mA at full scale	16 mA@12V DC, 20 mA@24V DC	External—50 mV at meter full scale	2 wire from shunt, 3 connections for backlight
8017	Standard Ammeter 0-100A DC	1 mA at full scale	16 mA@12V DC, 20 mA@24V DC	External—50 mV at meter full scale	2 wire from shunt, 3 connections for backlight
8018	Standard Ammeter 0-150A DC	1 mA at full scale	16 mA@12V DC, 20 mA@24V DC	External—50 mV at meter full scale	2 wire from shunt, 3 connections for backlight
8019	Standard Ammeter 0-200A DC	1 mA at full scale	16 mA@12V DC, 20 mA@24V DC	External—50 mV at meter full scale	2 wire from shunt, 3 connections for backlight



8254



8253

Part #	Function	Shunt Type	Connection	Meter Face Size in (mm)
8252*	Zero Center Ammeter 50-0-50A DC	External—50 mV at meter full scale	2 wire from shunt, 3 connections for backlight	2.75 (69.85)
8253*	Zero Center Ammeter 100-0-100A DC	External—50 mV at meter full scale	2 wire from shunt, 3 connections for backlight	2.75 (69.85)

*Meters read both discharge and charge current

DC Analog Voltmeter Panels

Enables voltage monitoring on up to 3 battery banks with one analog meter

- Includes standard 8003 DC Analog Voltmeter
- Displays voltage from 8-16V DC
- 3 position switch for multiple battery banks



8015

Traditional Metal

5.25" x 3.75" (133.35mm x 95.25mm)



1473

360 Panel System

4.88" x 4.75" (123.83mm x 120.65mm)

AC Analog Meters

Meters with backlighting for low light conditions

- Includes appropriate external transformer (p. 137) when required
- Backlit meter face (separate 12 or 24V DC backlight connections)



8244



9353

Part #	Function	Operating Amps (Meter)	Operating Amps (Backlight)	Connection
8244	Micro Voltmeter 0-150V AC	1 mA at full scale	16 mA@12V DC, 20 mA@24V DC	2 wire to AC hot and neutral, 3 connections for backlight
8245	Micro Voltmeter 0-250V AC	1 mA at full scale	16 mA@12V DC, 20 mA@24V DC	2 wire to AC hot and neutral, 3 connections for backlight
9353	Standard Voltmeter 0-150V AC	1 mA at full scale	16 mA@12V DC, 20 mA@24V DC	2 wire to AC hot and neutral, 3 connections for backlight
9354	Standard Voltmeter 0-250V AC	1 mA at full scale	16 mA@12V DC, 20 mA@24V DC	2 wire to AC hot and neutral, 3 connections for backlight



8246



9630

Part #	Function	Operating Amps (Meter)	Operating Amps (Backlight)	Connection
8246	Micro Ammeter 0-50A AC	50 mA at full scale	16 mA@12V DC, 20 mA@24V DC	2 wire from coil slipped over wire to be measured, 3 connections for backlight
9630	Standard Ammeter 0-50A AC	50 mA at full scale	16 mA@12V DC, 20 mA@24V DC	2 wire from coil slipped over wire to be measured, 3 connections for backlight
8258	Standard Ammeter 0-100A AC	50 mA at full scale	16 mA@12V DC, 20 mA@24V DC	2 wire from coil slipped over wire to be measured, 3 connections for backlight

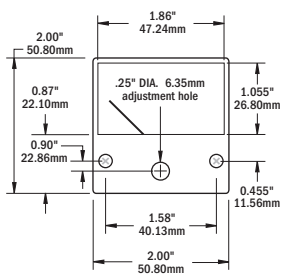

Micro Meter

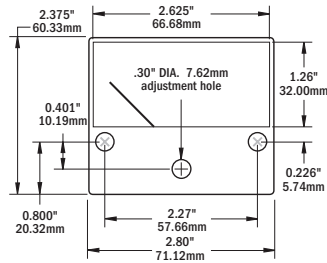

Standard Meter

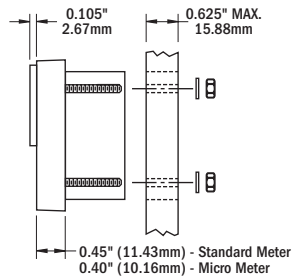

Surface Mount

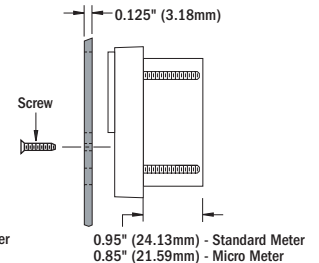

Panel Mount

M2 OLED Digital Meters

The M2 Organic LED Digital Monitor measures essential electrical system parameters with adjustable alarms and an auto-dimming display. The M2 Monitors include a MOSFET External Circuit Relay (ECR) which can be used to control external circuits based on any value measured by the M2.

- Auto-dimming, bright Organic LED display is easy to read
- 80dB alarm on all models
- Isolated 500mA MOSFET relay
- Includes external DC Shunt or AC Current Transformer when required

Display Size	55mm x 28mm
Power Supply Voltage	7V-70V DC*
Range (Power Consumption)	0.3W-1.0W

Regulatory
Monitor face is IP66 - protected against powerful water jet when installed according to instructions (see inside back cover)



1830



M2 OLED Mounting Options



Surface mount



Flat panel mount



1525 (meter not included)

Part #	Description	Width in (mm)	Height in (mm)
1525	360 Blank Panel - M2 OLED	4.88 (123.83)	4.75 (120.65)

M2 OLED Surface Mount

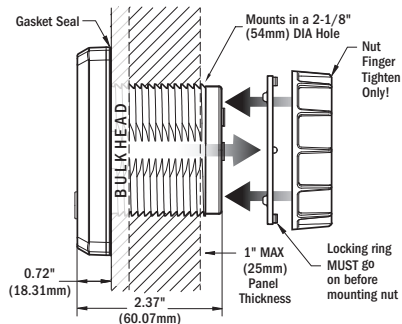

Related Products



AC Current Transformer
page 151



ML-Series Remote
Battery Switches
page 45



Temperature
Sensor
page 151



Floyd Bell Turbo
Series Alarm
page 154



DC Shunts
page 151



State-of-Charge

Battery State-of-Charge (SoC)

Knowing the State-of-Charge of your battery is like knowing the amount of fuel in your gas tank. To avoid getting stranded with a dead battery, accurate battery bank monitoring is essential.

Voltmeter Method—Voltage can be used to measure the SoC of your battery. The difference from a fully charged battery to a fully discharged battery is only 1.0V in a 12V system, so the meter must have good resolution and accuracy. This method is generally sufficient to monitor batteries which experience intermittent use, such as starter or thruster batteries. However, a battery must not have been charged or discharged for over 12 hours for this measurement to be trustworthy. This makes the Voltmeter Method unsuitable for monitoring house batteries which charge and discharge often.

Amp-Hour Method—A convenient and accurate way to measure SoC is with an Amp-Hour Monitor. This is a complex calculation of the energy available, energy consumed, and energy returned to the battery during charging. SoC is commonly expressed as a percent of amp-hours remaining until the battery is empty, but can also be expressed as amp-hours used, amp-hours remaining, or time remaining. The advantage of this method is that it works well for batteries in a constant state of charge and discharge.

* Variable with voltage, display intensity, and sleep mode

AC Meters



Part #	1836	1837	1838
Description	Ammeter	Voltmeter	Multimeter
Functions	Monitors current on two circuits	Monitors voltage on two circuits or both legs of 120/240V	Monitors voltage, current, frequency, and power on two circuits or both legs of 120/240V
Voltage			
Accuracy	--	± 1.0%	± 1.0%
Operating	7V-70V DC	7V-70V DC	7V-70V DC
Range	--	50V-250V AC (RMS)	50V-250V AC (RMS)
Resolution	--	1V AC	1V AC
Current			
Current Transformer	1 x Part # 8256 (150A/50mA)	--	1 x Part # 8256 (150A/50mA)
Accuracy	± 2.0%	--	± 2.0%
Range	0A-150A (300A optional) †	--	0A-150A (300A optional) †
Resolution (100 to 150)	1A	--	1A
Resolution (0.0 to 99.9)	0.1A	--	0.1A
Frequency			
Range	--	--	40Hz-90Hz
Resolution	--	--	1 Hz
Power			
Range	--	--	0W-45kW
Resolution (0W-9990W)	--	--	10W
Resolution (10kW-45kW)	--	--	0.1kW
Alarm/Relay Activation	High Current	High and Low Voltage	High and Low Voltage, Current

† Will achieve 300A with an optional current transformer Part # 1829 (p. 151)

Tank, Temperature & Bilge Meters



Part #	1839	1841	1842
Description	Tank	Temperature	Bilge
Functions	Monitors up to 4 tanks	Monitors up to 4 locations	Monitors up to 4 bilges
Operating	7V-70V DC	7V-70V DC	7V-70V DC
Senders	North American, 240Ω-33Ω European, 10Ω-180Ω Blue Sea Systems Ultrasonic (1810, 1811) Custom Ranges to 300Ω	2 x Part # 1820 2 x Part # 1821 (included)	Float switch or pumps with bilge active outputs. Not compatible with "fully automatic bilge pumps"
Alarm/Relay Activation	High and Low Level	High and Low Temperature	Run time/hr Cycles/24 hr Average Cycles
Other	Custom tanks shapes Auto calibration	Measures in Fahrenheit or Celsius -40°C - 120°C (-40°F - 250°F)	Cycle Counter

DC Meters



Part #	1830	1832	1833
Description	Multimeter w/SoC	Ammeter	Voltmeter
Functions	Monitors state-of-charge on one battery bank and voltage on three battery banks	Monitors current on two circuits	Monitors the voltage on up to four battery banks
Voltage			
Voltages	12V, 24V, 36, 48V	--	--
Accuracy	± 1.0%	--	± 1.0%
Operating	7V-70V DC	--	7V-70V DC
Resolution	0.01V DC	--	0.01V DC
Current			
Shunt	1 x Part # 8255 (500A/50mV)	1 x Part # 8255 (500A/50mV)	--
Accuracy	± 1.0%	± 1.0%	--
Range	-500A to 500A	-500A to 500A	--
Resolution (100 to 500)	1A	1A	--
Resolution (99.9 to 500)	0.1A	0.1A	--
Alarm/Relay Activation	High and Low Voltage, High Current, and Low Battery	High Current,	High and Low Voltage



Part #	1850
Description	Vessel Systems Monitor
Functions	Performs comprehensive monitoring of four systems
DC Specs.	
Nominal System Voltage	12V, 24V, 36V, 48V
Operating	7V-70V DC
Minimum Current Draw	15 mA @12V, display off 8 mA @ 24V, display off
Voltage Accuracy	± 1%
Range	-500A to 500A
Current Accuracy	± 1.0%
AC Specs.	
Nominal System Voltage	120V @ 60Hz, North America 230V @ 50Hz, Typical of Europe
Operating Voltage	0-300V
Voltage Accuracy	± 1.0%
Current Range	0-150A
Current Accuracy	± 2%
Frequency	40-90Hz

M2 Vessel Systems Monitor (M2 VSM)

Performs comprehensive monitoring of four critical systems in one compact organic LED digital monitor

DC System Monitoring (up to two batteries)

One input monitors the DC voltage, state-of-charge, current for one battery bank and another input monitors the voltage of an additional battery bank. Alarms include high and low voltage, high current, and low battery.

AC System Monitoring

The VSM monitors a single AC voltage, current, and frequency. Alarms include high and low voltage, high current, and high and low frequency.

Bilge & Tank Monitoring

The M2 VSM has two inputs that can be configured as a bilge or tank monitor. When configured as a bilge input, monitoring functions include pump active, cycle count in the last 24-hours, average cycles in a typical 24-hour period, and total cycles. High alarms can be set for both the minutes of run time in the last hour as well as the number or cycle counts in the last 24-hours. When configured as a tank input, tank status can be represented in both capacity (gallons or liters) or as a percentage of capacity. Custom tank shapes can be auto-calibrated or programmed. Both high and low level alarms can be set for all tanks.

DC Specifications

Nominal System Voltage	12V, 24V, 36V, 48V
Operating Voltage	7-70V
Minimum Current Draw	15mA @ 12V, display off 8mA @ 24V, display off
Voltage Accuracy	+/- 1%
Current Range	-500A to 500A
Current Accuracy	+/- 1%

AC Specifications

Nominal System Voltage	120V @ 60Hz, North America 230V @ 50Hz, Typical of Europe
Operating Voltage	40-300V
Voltage Accuracy (RMS)	+/- 1%
Current Range	0-150A
Current Accuracy (RMS)	+/- 2%
Frequency	40-90Hz

Regulatory

Monitor face is IP66 - protected against powerful water jet when installed according to instructions (see inside back cover)

Tank Senders Supported:

- 10-180 Ω VDO
- 240-33 Ω Teleflex
- Blue Sea Systems Ultrasonic Tank Senders (sold separately)
 - For diesel, water, or waste 1810 (32" tank depth)
 - For gasoline 1811 (24" tank depth)

Retail Packaging Includes:

head unit, display cover, surface mount bezel, surface mount gasket, DC Current Shunt 8255, AC Current Transformer 8256, connectors, mounting screws and screw driver

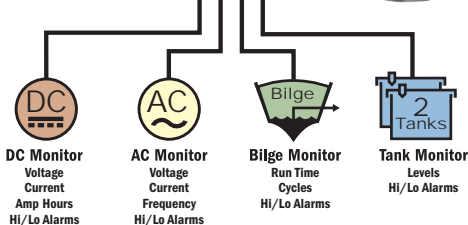

Part #	Description
1850	M2 VSM
1810	32" Diesel, Water, Waste tank sender for use with VSM 422 & M2 VSM
1811	24" Gasoline tank sender for use with the VSM 422 & M2 VSM

Connection Table

System	Inputs	Functions
DC	2	DC Voltage Battery 1, State-of-Charge, & Current DC Voltage Battery 2
AC	1	AC Voltage, Current, & Frequency
Auxiliary	2	Auxiliary 1: Tank or Bilge Auxiliary 2: Tank or Bilge

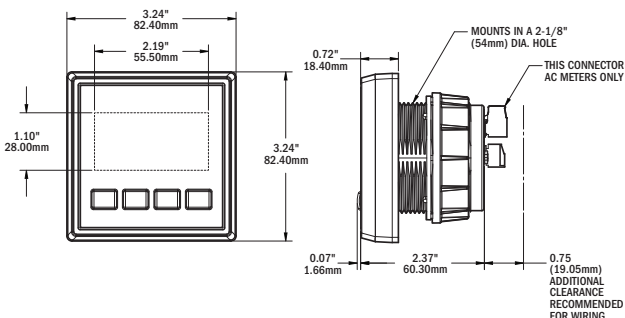
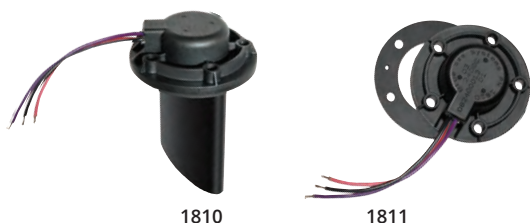

Mini OLED Meters

Monitors essential electrical system parameters, temperature, and tank levels, on a bright, waterproof, daylight readable OLED screen

- Compact size enables mounting in any convenient location
- Now available with yellow or blue OLED screens
- Reverse polarity protected
- Mounts in a common 1-1/8" in hole

EXPANDED OFFERING

Cutout Dimensions 1-1/8" (29 mm) diameter
 Lifecycles Blue OLED: 10,000 hours
 Yellow OLED: 100,000 hours

Regulatory
 CE marked
 IP66 - protected against powerful water jets (see inside back cover)

Part #	1733 1733200	1732 1732200	1741 1741200	1739 1739200
Description	Voltmeter	Ammeter	Temp Meter	Tank Meter
Nominal Voltage	12 / 24V DC	12 / 24V DC	12 / 24V DC	12 / 24V DC
Input Voltage	8V-36V DC	8V-36V DC	8V-36V DC	8V-36V DC
Max. Operating Current	15mA	15mA	10mA	17mA
Resolution	0.01V DC	0.1A	1°F or 1°C	5%
Accuracy	+/- 1%	+/- 2%	+/- 1.25%	--
Intermittent: 5 min.	--	110A	--	--
Cranking: 30 sec.	--	175A	--	--
DC Shunt (included)	--	9230 (100A/50mV)	--	--
Temp Sensor (included)	--	--	1820	--
Monitors	8V-36V DC	-100A -100A DC	-40°F -175°F * or -40°C -80°C *	Tank Level
Compatible Senders	--	--	--	North American: 240-33Ω European: 10-180Ω

* -40°F-250°F (-40°C-120°C) with sensor Part # 1821 (Optional)

5 YEAR WARRANTY



1733200 Blue OLED
 1733 Yellow OLED



1741200 Blue OLED
 1741 Yellow OLED



1732200 Blue OLED
 1732 Yellow OLED



1739200 Blue OLED
 1739 Yellow OLED

Related Products



DC Shunts page 151



Temperature Sensor page 151



Water-Resistant USB Accessory Panels page 28

Mini Clamp Multimeter

Compact and feature-rich AC/DC Multimeter simplifies diagnosis of marine electrical problems

- Clamp allows measurement of AC and DC current in wires without disturbing the circuits or contacting live terminals
- Compact size allows comfortable one hand operation, portability, and access to confined areas
- Auto range simplifies operation by automatically selecting the range that best fits the data
- Additional functions include: Data Hold, Overload Display, and AutoPower-Off
- True RMS AC measurement is accurate for normal sine wave and modified sine wave inverter output

AC Amps	0.01-400A
AC Volts	0.001-600V
DC Amps	0.01-400A
DC Volts	0.001-600V
Resistance/Continuity Alarm	0.1-40MΩ
Measurement Resolution	4300 counts
Regulatory CE marked, CAT III, 600 Volts	

Part #	Description
8110	Mini Clamp Multimeter



Includes test leads and carrying case

DC Digital Meters

Monitors key DC functions

- Large, bright LED characters
- Three levels of brightness
- Splash-proof front
- Easy to surface mount in a 2" round hole

Display Character Size	9/16"
Power Supply Voltage	8-50V DC
Max. Power Consumption	1.00W*
Min. Power Consumption	0.60W*



8251

DC Voltmeter with Alarm

Voltage Measurement:	
Range	0-60V DC
Resolution	0.01V DC
Accuracy (% of Reading)	± 0.5%**



8248

DC Multimeter with Alarm

Voltage Measurement:	
Range	0-60V DC
Resolution	0.01V DC
Accuracy (% of Reading)	± 0.5%**
Current Measurement:	
Shunt (Included)	500A/50mV
Range	± 500A DC
Resolution (-100 to -500)	1A DC
Resolution (-99.9 to +500)	0.1A DC
Accuracy (% of Reading)	± 0.5%**



8236

DC Ammeter

Current Measurement:	
Shunt (Included)	500A/50mV
Range	± 500A DC
Resolution (-100 to -500)	1A DC
Resolution (-99.9 to +500)	0.1A DC
Accuracy (% of Reading)	± 0.5%**



8235

DC Voltmeter

Voltage Measurement:	
Range	0-60V DC
Resolution	0.01V DC
Accuracy (% of Reading)	± 0.5%**

Digital Meter Front Panel Mount

Surface mounting features a finger nut and locking ring for quick and easy installation into a 2.00" (50.8mm) diameter hole.

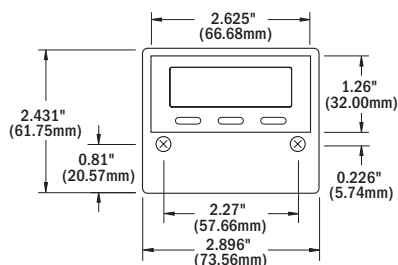
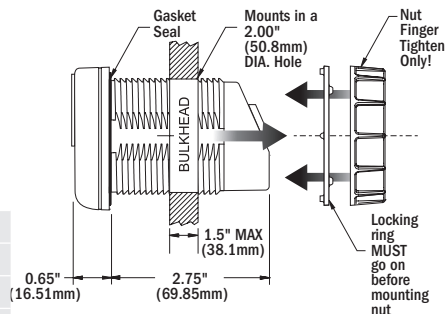

DC Digital Voltmeter Panels

Enables voltage monitoring on up to 3 battery banks with one digital meter

- Includes 8235 DC Digital Voltmeter
- 4 digit LED display—Displays voltage from 0-60V DC
- 3 position switch for multiple battery banks



8051



1474

Part #	Description	Measurement	Sleep Mode	Alarms
8248	DC Multimeter with Alarm	Voltage, Current	Programmable	High and low voltage
8235	DC Voltmeter	Voltage	Manual	--
8251	DC Voltmeter with Alarm	Voltage	Programmable	High and low voltage
8236	DC Ammeter	Current	Manual	High and low voltage

Part #	Width in (mm)	Height in (mm)
8051	5.25 (133.35)	3.75 (95.25)
1474	4.88 (123.83)	4.75 (120.65)

* Variable with voltage, display intensity, segments illuminated, and sleep mode
 **± 1 (Least Significant Digit)

AC Digital Meters

Monitors key DC functions

- Large, bright LED characters
- Three levels of brightness
- Splash-proof front
- Easy to surface mount in a 2" round hole

Display Character Size	9/16"
Input Voltage	80–249V AC*
Max. Power Consumption	1.00W*
Standby Power	0.60W*



8238

AC Ammeter

Current Measurement:	
Current Transformer	150A/50mA
Range 1 (Resolution 0.01A)	0.00–9.99A AC (RMS)
Range 2 (Resolution 0.1A)	10.0–150.0A AC (RMS)
Accuracy (% of Reading)	± 3.0%***



8237

AC Voltmeter

Voltage Measurement:	
Range	80–249V AC*
Resolution	0.1V AC
Accuracy: (% of Reading)	
90–249V AC (RMS)	± 2.0%***
70–90V AC (RMS)	± 5.0%***

Part #	Description	Measurement	Sleep Mode	Alarms
8238	AC Ammeter	Current	Manual	--
8247	AC Multimeter with Alarm	Voltage, Current, Frequency, Power	Programmable	High and low voltage, High current
8237	AC Voltmeter	Voltage	Manual	--



8247

AC Multimeter with Alarm

Voltage Measurement:	
Range	80–249V AC*
Resolution	0.1V AC
Accuracy: (% of Reading)	
90–249V AC (RMS)	± 2.0%***
70–90V AC (RMS)	± 5.0%***
Current Measurement:	
Current Transformer	150A/50mA
Range 1 (Resolution 0.01A)	0.00–9.99A AC (RMS)
Range 2 (Resolution 0.1A)	10.0–150.0A AC (RMS)
Accuracy (% of Reading)	± 3.0%***
Frequency Measurement:	
Range	40–90Hz
Resolution	0.1Hz
Accuracy (% of Reading)	± 0.1%***
Calibrated with sine wave input	
Power Measurement:	
Range 1 (Resolution 10W)	0–9990W
Range 2 (Resolution 0.1kW)	10–45kW
Accuracy (% of Reading)	± 5%***

Included Current Transformer 8256 (p. 145)

120/240V AC Digital Meter Mounting Panel

For monitoring 120/240V AC Systems

- Use with AC Digital Multimeter 8247 for monitoring 120/240V AC Systems
- Monitor Line 1 or Line 2 to Neutral and Line 1 to Line 2 voltages
- Includes two additional Current Transformers 8256 (p. 151) and mounting screws



8410 (meter not included)

120/240V AC Digital Meter Blank Panel

Part #	Width in (mm)	Height in (mm)
8410	5.25 (133.35)	3.75 (95.25)

Analog and Digital Meter Mounting Panels

Provides an easy method of mounting meters

- Panel mounts standard 2-3/4" Analog or Digital Meters
- Includes mounting screws and center adjustment hole plug



8013 (meter not included)

Accepts (1) 2-3/4" Analog or Digital Meter



1475 (meter not included)

Accepts (1) 2-3/4" Analog or Digital Meter





Part #	Width in (mm)	Height in (mm)
1475	4.88 (123.83)	4.75 (120.65)
8013	5.25 (133.35)	3.75 (95.25)

* For 120 & 240 Volt AC single phase systems







** Variable with voltage, display intensity, segments illuminated, and sleep mode



*** ± 5 LSD (Least Significant Digit)









Meter Comparison







DC Voltmeters						
M2 OLED	Digital	Mini OLED	Analog Micro	Analog Standard		
						
p. 145	p. 148	p. 147	p. 142	p. 142		
1833	8235 8251*	1733 & 1733200	8028	8003 8240		
7-70V	0-60V	8-36V	8-16V	8-16V 18-32V		
4 channels	1 channel	1 channel	1 channel	1 channel		

* with alarm

AC Voltmeters					DC Ammeters		
M2 OLED	Digital	Analog Micro		Analog Standard	M2 OLED	Digital	Mini OLED
							
p. 145	p. 149	p. 143		p. 143	p. 145	p. 148	p. 147
1837	8237	8244	8245	8246	9353	9354	1832 8236 1732 & 1732200
50-250V	80-249V	0-150V	0-250V	0-50V	0-150V	0-250V	±500A ±500A ±100A
2 channels AC	1 channel	1 channel		1 channel	2 channels	1 channel	1 channel

DC Ammeters									
Analog Standard									
									
p. 142	8005			8022	8017	p. 142	8018	8019	8252 8253
0-50A	0-25A	0-50A	0-100A	0-150A	0-200A	50-0-50A	100-0-100A	1 channel	

AC Ammeters			Bilge, Tank, and Temperature				
M2 OLED	Digital	Analog Standard	M2 OLED	M2 OLED	Mini OLED	Mini OLED	M2 OLED
							
p. 145	p. 149	p. 143	p. 145	p. 145	p. 147	p. 147	p. 145
1836	8238	9630 8258	1842	1839	1739 & 1739200	1741 & 1741200	1841
0-150A	0-150A	0-50A 0-100A	Up to 4 bilges	Up to 4 tanks	1 tank	-40°C-120°C	-40°C-120°C
2 channels	1 channel	1 channel	4 channels	4 channels	1 channel	1 channel	4 channels

DC Multimeter w/SoC	DC Multimeter	AC Multimeters		AC/DC Multimeters	
M2 OLED	Digital	M2 OLED	Digital	M2 OLED VSM	Mini Clamp
					
p. 145	p. 148	p. 145	p. 149	p. 145	p. 147
1830	8248	1838	8247	1850	8110
12V, 24V, 36V, 48V 7-70V ±500A	0-60V ±500A	50-300V 0-150A 40-90Hz 0-45kW	80-249V 0-150A 40-90Hz 0-45kW	7-70V DC, ± 500A DC 40-300V AC, 0-150A AC Bilge, Tank, State-of-Charge	0.01-400A AC 0.001-600V AC 0.01-400A DC 0.001-600V DC
3 x V DC channels 1 x A DC channel 1 x SoC channel	1 x V DC channel 1 x A DC channel	2 x V AC channels 2 x A AC channels	1 x V AC channel 1 x A AC channel	up to 5 channels	-

DC Shunts

Use with DC Ammeters

- For continuous operation, it is recommended that shunts not be run at more than two-thirds (66%) the rated current under normal conditions

Shunt Type	Resistive
Full Scale	50 mV
Amperage Max. Operating	66% of Rated Current
Amperage Int. (5 min.)	100% - Full scale rating
Amperage Int. (3 sec.)	300% - Full scale rating

Part #	For Use With:	Ratio
9228	Analog Ammeter	50A DC/50mV DC
9230	Analog Ammeter	100A DC/50mV DC
9231	Analog Ammeter	150A DC/50mV DC
9233	Analog Ammeter	200A DC/50mV DC
8255	Digital Ammeter	500A DC/50mV DC



9228



9233



8255

Gauge Panel

For Round Gauges



(Gauge not included)

Part #	Width in (mm)	Height in (mm)	Depth in (mm)
1510	4.88 (123.83)	4.75 (120.65)	0.50 (12.70)

Temperature Sensors

Use with the P12 Battery Charger, M2 OLED Meters, M2 VSM, VSM 422, and Mini OLED Meters

- Installs with double-sided tape

Wire Size	16 AWG
Wire Length 1820	12" (31 cm)
Wire Length 1821	18" (46 cm)



1820



1821

Part #	IP Rating	Temperature Range
1820	IP68 Submersible	-40°F to 175°F (-40°C to 80°C)
1821	IP65 Non-submersible	-40°F to 300°F (-40°C to 150°C)

AC Current Transformers

Use with AC Ammeters

Part #	For Use With:	Ratio
8073	Analog Ammeter	50A AC/50mA AC
8257	Analog Ammeter	100A AC/50mA AC
8256	Digital, M2 Ammeter & M2 VSM	150A AC/50mA AC
1829	M2 Ammeter	300A AC/50mA AC



1829



8073

Related Products



2719 Enclosure
page 104



Mini OLED
Digital Meters
page 147



M2 OLED
Digital Meters
page 145



Digital Meters
page 148



Mini
Analog Meters
page 142



Standard
Analog Meters
page 142

ACCESSORIES

Floyd Bell Turbo Alarm

154



Adjustable extra loud volume and beep tone audibly alerts operator.

Insulating Back Covers

154

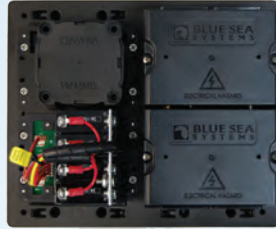

Provides electrical insulation for exposed panel backs.

120V AC Dual Outlet

154

NEW



Provides a 360 Panel System platform for mounting equipment, switching, and monitoring functions.

LED Indicators

155



LED Indicator Lights are easy to install, available in an assortment of colors, and provide visual indication of power or alerts.



ACCESSORIES

Lockout Slides

155



Enables safe management of multiple AC sources which use double or triple pole circuit breakers.

Toggle Guard

155

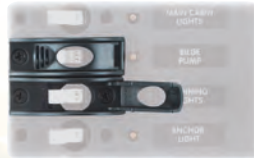

Protects toggle circuit breakers from accidental switching.

Labels

156

CABIN LIGHTS

CABIN LIGHTS

CABIN LIGHTS



Over 500 standard labels are available in large, small, square and round formats for use on Blue Sea Systems products including fuse blocks, busbar insulating covers, panels, switches and Contura switches. Custom Labels are available in any language and ship rapidly from the in-house printing facility. Labels can be easily ordered online at www.blueseasystems.com/labels.



Blue Sea Systems offers a range of panel accessories which support four panel styles.

ABYC standards mandate isolation of AC and DC components on combination panels. Stackable, screw-down covers protect AC components from coming into contact with tools, personnel, and DC wiring. Traditional Metal and 360 Panel System accessories include back covers for panels.

Floyd Bell Turbo Series DC Audible Alarm

Extra loud beep tone audibly alerts operator



- Rotating bezel adjusts alarm volume
- Threaded attachment ring
- Fits 1 inch round aperture

Voltage Nominal	12V / 24V DC
Operating Voltage	5–30V DC
Operating Current	5 mA @ 5V DC 25 mA @ 30V DC
Sound Level @ 25°C and 24"	85±5 dB(A) @ 5V DC 103±5 dB(A) @ 30V DC
Operating Frequency	2900 ± 250 Hz
Terminals	Male 1/4" Quick Connect

Regulatory
IP68 - Withstands water submergence and dust exposure
UL Recognized

Part #	Description
1070	Floyd Bell Turbo Series Alarm

Related Product



m-LVD Low Voltage Disconnect
page 42

360 Panel 12V to 24V DC Conversion Kit

Converts indicator LEDs from 12V DC systems to 24V DC systems



- Requires one kit per 12 Volt DC circuit breaker module
- Includes wire harness and panel identification label

Part #	Description
4113	360 Panel 12V to 24V DC Conversion Kit

360 Panel Insulating Back Covers

Provides electrical insulation for exposed panel backs



- Isolation of AC from DC components
- Meets ABYC safety requirements for panels with combined AC and DC loads
- Modular design consists of interlocking pieces
- Interlocking pieces can be stacked to accommodate large components
- Cover breakouts allow wire access in any direction

Material	UL 94-V0 Polycarbonate
Hardware	2 qty. #6 Phillips-drive sheet metal screws, 4 qty. #8-32 x 0.5" Phillips-drive machine screws with lock washers

Part #	Description
1331	Cover for 1 module

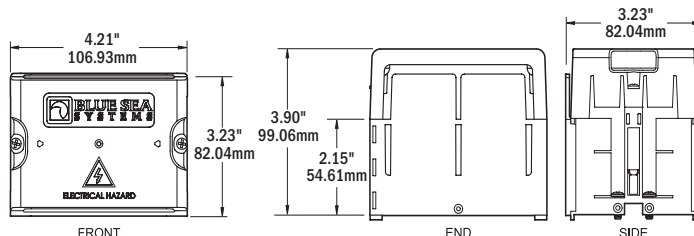

360 Panels

Provides a 360 Panel System platform for mounting equipment, switching, and monitoring functions

EXPANDED OFFERING

- 1518 is suitable for mounting accessories and for pad printing
- 1499 provides continuous ground fault protection and auto-monitoring



1518



1479



1499

Part #	Panel Description	Width in (mm)	Height in (mm)	Depth in (mm)
1518	Blank	4.88 (123.83)	4.75 (120.65)	0.50 (12.70)
1479	120V AC Dual Outlet	4.88 (123.83)	4.75 (120.65)	1.00 (25.40)
1479100	Blank Outlet	4.88 (123.83)	4.75 (120.65)	0.50 (12.70)
1499	20A, 120V AC GFCI Dual Outlet	4.88 (123.83)	4.75 (120.65)	1.00 (25.40)

AC Insulating Back Covers

Provides electrical insulation for many of Blue Sea Systems Traditional Metal circuit breaker panels

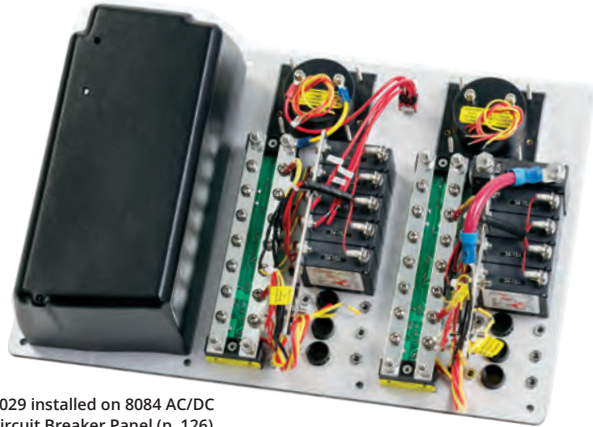

4029 installed on 8084 AC/DC Circuit Breaker Panel (p. 126)

- Isolation of panel AC components from DC components
- Provides mechanical protection for panel backs
- Lightweight material is easily drilled for wire pass-through
- Meet ABYC safety requirements
- 4029 and 4031–Used only for Blue Sea Systems toggle circuit breaker panels

Material	UL-94-V0 Thermoplastic
----------	------------------------

Part #	Description
4026	Cover for 5-1/4" x 3-3/4"
4027	Cover for 5-1/4" x 7-1/2"
4028	Cover for 10-1/2" x 7-1/2"
4029	Cover for 1 Column x 8 Position + Meter
4031	Cover for 2 Column x 10 Position + Meter

LED Indicator Lights

Directly replaces LEDs used in Blue Sea Systems Traditional Metal circuit breaker panels



- Simple push-in installation mounts in any thickness material
- Useful as general indicator and alarm lights

Mounting Hole Size	11/64" (4.36 mm)
Wire Gauge	26 AWG

Part #	Color	Nominal Voltage	Current (mA)	Power Consumption (mW)	Circuit
8033	Amber	12 / 24V DC	1.5 @ 12V 3.1 @ 24V	19 @ 12V 75 @ 24V	Resistor
8171	Red	12 / 24V DC	1.5 @ 12V 3.2 @ 24V	19 @ 12V 77 @ 24V	Resistor
8172	Green	12 / 24V DC	1.5 @ 12V 3.0 @ 24V	19 @ 12V 73 @ 24V	Resistor
8169	Amber	120V AC	2.3 @ 120V	278 @ 120V	Resistor
8066	Red	120V AC	2.7 @ 120V	326 @ 120V	Resistor
8034	Green	120V AC	2.3 @ 120V	278 @ 120V	Resistor
8167	Amber	250V AC	1.1 @ 250V	276 @ 250V	Resistor + Diode
8166	Red	250V AC	1.1 @ 250V	276 @ 250V	Resistor + Diode
8134	Green	250V AC	1.1 @ 250V	276 @ 250V	Resistor + Diode

C-Series Circuit Breaker Lockout Slide

Enables safe management of multiple AC sources which use double or triple pole circuit breakers



4130

4131

- Allows only 1 of a pair of double pole or triple pole AC toggle circuit breakers to be activated at a time
- Ensures AC power from 2 sources will not be mixed
- Fits all double or triple pole C-Series Toggle Circuit Breakers (p. 86)
- Uses circuit breaker mounting screw holes
- Includes mounting screws

Part #	Poles	AC Sources	Mounting
4130	2	2	#6 Pan Head Screw
4131	3	2	#6 Pan Head Screw

A-Series Circuit Breaker Lockout Slide

Enables safe management of multiple AC sources which use double pole circuit breakers

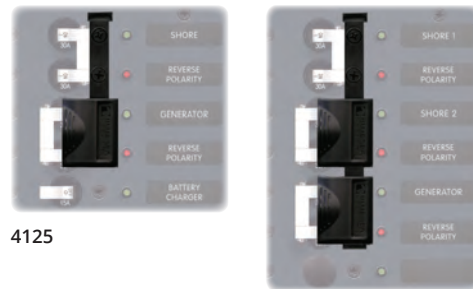

4125

4126

- Allows 1 double pole AC toggle circuit breaker to be activated
- Ensures AC power from 2 or more sources will not be mixed
- Fits all double pole A-Series Toggle Circuit Breakers (p. 84)
- Uses circuit breaker mounting screw holes
- Includes mounting screws

Part #	Poles	AC Sources	Mounting
4125	2	2	#6 Flat Head Screw
4126	2	3	#6 Flat Head Screw

Toggle Guard

Protects toggle circuit breakers from accidental switching

- Fits A-Series single pole toggle circuit breakers (p. 84)
- Fits all panel switches (p. 98)
- Uses circuit breaker mounting screw holes
- Includes mounting screws



2 shown

Part #	Description	Mounting
4100	Toggle Guard	#6 Flat Head Screw

Small Format Labels

Reinforced, waterproof labels

- Used on most Blue Sea Systems Contura Switch Water Resistant Panels (p. 116) and ST-Blade Fuse Blocks (p. 64-69)
- For a list of labels included see (p. 157)

Part #	Color	Quantity
8214	Black	60 Labels
8217	Gray	60 Labels

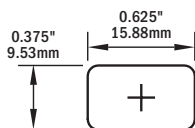

Square Format Labels

Reinforced, waterproof labels

- Used on 360 Panels (p. 118, 134), Battery Management Panels (p. 40), ST CLB Circuit Breaker Blocks (p. 76), SMS System (p. 90), and WeatherDeck® Panels (p. 117)
- For a list of labels included see (p. 157)
- Available for purchase in sets or individually (p. 156-159)

Part #	Color	Description	Quantity
4215	Black	DC Labels	30 Labels
4218	Black	DC Labels	30 Labels
4216	Black	DC Labels	60 Labels
4217	Black	DC Labels	120 Labels

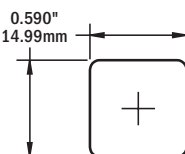

4215

Large Format Labels

Reinforced, waterproof labels

- Used on Contura Water Resistant Fuse Panels 8053 & 8054 (p. 116)
- ST Glass Fuse Blocks (p. 63) and Traditional Metal Panels (p. 119)
- Available for purchase in sets or individually (p. 156-159)
- For a list of labels included see (p. 157)

Part #	Color	Description	Quantity
8031	Black	AC Panel Basic	30 Labels
8067	Black	AC Panel Extended	120 Labels
8030	Black	DC Panel Basic	30 Labels
8039	Black	DC Panel Extended	120 Labels

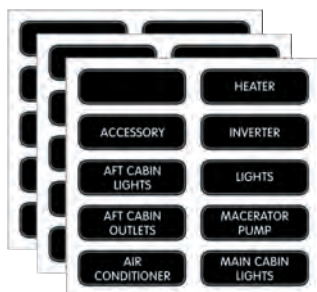
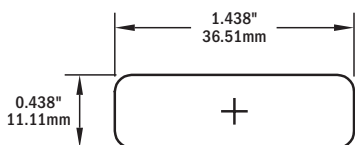

8031

Related Products



4121, 8065, 8069, 8383, 8384
Label Backlight Systems
See blueseas.com

Push Button Switches
page 97

Push Button Switch Label Kit
page 97

Round Icon Labels NEW

Reinforced, waterproof labels

- Used on 15A Backlit Push Button Switches (p. 97)
- Also available in a kit Part # 4230 (p. 97)
- To order individual labels, please indicate the Part # 6526 and the label number. Examples below.

Individual Example:
Round Icon Individual
6526-1001



Part #	Description	Label	Part #	Description	Label
1001	ACCESSORY	ACC	1027	LIGHT 1	
1002	ACCESSORY 1	ACC 1	1028	LIGHT ANCHOR	
1003	ACCESSORY 2	ACC 2	1029	LIGHT COURTESY	
1004	ACCESSORY 3	ACC 3	1030	LIGHT COURTESY 1	
1005	AERATOR		1031	LIGHT COURTESY 2	
1006	ALARM		1032	LIGHT FLOOD BOW	
1007	ANCHOR		1033	LIGHT FLOOD COCKPIT	
1008	AUTO PILOT	AUTO PILOT	1034	LIGHT RUNNING	
1009	BATTERY SWITCH		1035	LIGHT SPREADER	
1010	BILGE BLOWER		1036	LIGHT SPREADER 2	
1011	BILGE PUMP		1037	LIGHT UNDERWATER BOW	
1012	BILGE PUMP 1		1038	LIGHT UNDERWATER STERN	
1013	BILGE PUMP 2		1039	LIVEWELL	
1014	BILGE PUMP 3		1040	LIVEWELL 1	
1015	BLANK		1041	RADAR	
1016	DC OUTLET	DC OUTLET	1042	SASQUATCH	
1017	DEPTH SOUNDER		1043	STEREO	
1018	ENGINE OFF		1044	THRUSTER	
1019	ENGINE START		1045	TRIM TAB	
1020	FAN		1046	VHF	
1021	FRESH WATER		1047	WASH DOWN	
1022	GPS		1048	WINDSHIELD WASHER	
1023	GYRO		1049	WINDSHIELD WIPER CENTER	
1024	HORN		1050	WINDSHIELD WIPER LEFT	
1025	HOSE DOWN		1051	WINDSHIELD WIPER RIGHT	
1026	LIGHT				

Labels Included in Sets

4215

ACCESSORY
AERATOR
ANCHOR LIGHT
AUTOPILOT
BAIT PUMP
BILGE PUMP
BLOWER
CABIN LIGHTS
DEPTH SOUNDER
ELECTRONICS
GPS
HORN
INSTRUMENTS
KNOTMETER
NAV LIGHTS
RADAR
REFRIGERATOR
RUNNING LIGHTS
SEARCH LIGHT
SPARE
SPREADER LIGHTS
STEAMING LIGHT
STEREO
TRIM TABS
VHF
WASH DOWN
WATER PRESSURE
WATER PUMP
WINDLASS
WIPERS

4206 and 8031

(BLANK)
ACCESSORY
AFT CABIN LIGHTS
AFT CABIN OUTLETS
AIR CONDITIONER
AIR CONDITIONER 2
APPLIANCES
BATTERY CHARGER
CABIN OUTLETS
COMPUTER
ENTERTAINMENT CENTER
FWD CABIN LIGHTS
FWD CABIN OUTLETS
GALLEY
GALLEY OUTLETS
HEATER
INVERTER
LIGHTS
MACERATOR PUMP
MAIN CABIN LIGHTS
MAIN CABIN OUTLETS
MICROWAVE
OUTLETS
REFRIGERATOR
SPARE
STOVE
TV/STEREO
VCR
WASHER/DRYER
WATER HEATER

4217

(BLANK)
12 VOLT DC
12 VOLT DC OUTLETS
24 VOLT DC
AIR HORN
ANCHOR LIGHT MAIN
ANCHOR LIGHT MIZZEN
ANCHOR WASH DOWN
APPLIANCES
ARCH LIGHTS
AUTO/MAN
BAITWELL
BATTERY
BATTERY PARALLEL
BILGE ALARM
BILGE PUMP 2
BILGE PUMP ON-OFF-AUTO
BOW LIGHT
BOW THRUSTER
BRIDGE INSTRUMENTS
BRIDGE LIGHTS
CABIN
CB RADIO
CD PLAYER
CHART LIGHT
CHART PLOTTER
COCKPIT LIGHTS
COMPASS LIGHT
COURTESY LIGHTS
DAVIT

DC OUTLETS
DC SUB PANEL
DECK LIGHTS
DEFROSTER
DEPTH/SPEED
DIMMER
DISCHARGE PUMP
DOCKING LIGHT PORT
DOCKING LIGHT STBD
DOCKING LIGHTS
DOWN RIGGER
ELECTRIC HATCH
ENGINE HATCH
ENGINE INSTRUMENTS
ENGINE ROOM BLOWERS
ENGINE ROOM LIGHTS
ENGINE SHUTDOWN
ENTRY STEP
FAN
FAN 2
FIRE ALARM
FIRE EXT
FISH FINDER
FISHING LIGHT
FISHWELL PUMP
FLOOD LIGHTS
FLYBRIDGE
FLYBRIDGE ELECTRONICS
FLYBRIDGE LIGHTS
FOG LIGHTS

FOREDECK LIGHT
FRESH WATER PUMP
FRESH WATER WASH DOWN
FUEL PUMP
FUEL TRANSFER
FURLER JIB
FURLER MAINSAIL
GALLEY
GAS ALARM
GPS/PLOTTER
HAILER
HAM RADIO
HEAD
HEATER
IGNITION
INSTRUMENT LIGHTS
INTERCOM HAILER
LAZARETTE LIGHTS
LIGHTER
LIGHTS
LIVWELL
LOCKER LIGHTS
LPG CONTROL
MAIN
MAST LIGHTS
MASTHEAD LIGHT
MIZZEN FLOOD
NAVIGATION ELECTRONICS
NAVIGATION INSTRUMENTS
NAV LIGHT ANCHOR OFF NAV

ON-OFF
OUTLETS
PUMP
PUMPOUT
RADIO
ROD LOCKER
RUDDER ANGLE INDICATOR
SAILING CONTROLS
SAILING INSTRUMENTS
SALT WATER PUMP
SEAWATER WASH DOWN
SHOWER SUMP PUMP
SOLAR PANEL
SSB
START-STOP
STERN LIGHT
STROBE LIGHT
SUMP PUMP
TRANSFER
TRICOLOR LIGHT
TROLLING MOTOR
WASHDOWN PUMP
WASHDOWN
WINCHES
WIND GENERATOR
WIND INSTRUMENTS
WINDSHIELD WASHER
WIPER CENTER
WIPER PORT
WIPER STBD

8214 and 8217

(BLANK)
12 VOLT DC
24 VOLT DC
ACCESSORY
AERATOR
ANCHOR LIGHT
AUTO PILOT
BAIT PUMP
BAITWELL
BATTERY
BATTERY CHARGER
BILGE
BILGE PUMP
BLOWER
BOW LIGHT
CABIN
CABIN LIGHTS
CB RADIO
CELLULAR PHONE
CHARGER INVERTER
CHART PLOTTER
DECK LIGHTS
DEPTH SOUNDER
DOWN RIGGER
ELECTRONICS
FAN
FISH FINDER
FISHING LIGHT
FLOOD LIGHTS
FUEL PUMP
GAS ALARM
GPS
HORN
IGNITION
INSTR. LIGHTS
INVERTER
KNOT METER
LIGHTS
LIVWELL
NAV LIGHTS
OUTLETS
RADIO
RADAR
REFRIGERATION
RUNNING LIGHTS
SEARCH LIGHT
SPREADER LIGHTS
STEAMING LIGHT
STEREO
STROBE LIGHT
TRICOLOR LIGHT
TRIM TABS
USB CHARGER
VHF
WASH DOWN
WATER PRESSURE
WATER PUMP
WINCHES
WINDLASS
WIPERS

4218

12 VOLT DC
24 VOLT DC
ALARM
BILGE PUMP
BILGE PUMP 2
BILGE PUMP 3
BILGE PUMP 4
BOW THRUSTER
CLOCK
DC MAIN
DC SUB PANEL
ELECTRONICS
ENGINE
ENGINES
ENG 1/ENG 2
GENERATOR
HOUSE
HOUSE/ENG
HOUSE/GEN
INVERTER
LIGHTS
MEMORY
PORT/STBD ENG
RADAR
RADIO
SOLAR PANEL
VHF
WINCH
WINDLASS
Blank (Write On)

4216

(BLANK)
12 VOLT DC
12 VOLT DC OUTLETS
ANCHOR WASH DOWN
BAITWELL
BATTERY
BATTERY PARALLEL
BILGE
BILGE PUMP 2
BILGE PUMP ON-OFF-AUTO
BOW LIGHT
CABIN
CB RADIO
CELLULAR PHONE
CHART LIGHT
CHART PLOTTER
COCKPIT LIGHTS
COMPASS LIGHT
COURTESY LIGHTS
DAVIT
DC OUTLETS
DC SUB PANEL
DECK LIGHTS
DOCKING LIGHTS
DOWN RIGGER
ELECTRIC HATCH
ENGINE ROOM BLOWER
ENGINE ROOM LIGHTS
FAN
FISH FINDER
FISHING LIGHT
FISHWELL PUMP
FLOOD LIGHTS
FRESH WATER PUMP
FUEL PUMP
GALLEY OUTLETS
GAS ALARM
GPS/PLOTTER
HEAD
IGNITION
INSTRUMENT LIGHTS
LIGHTS
LIVWELL
MACERATOR PUMP
NAV LIGHT ANCHOR-OFF-NAV
OUTLETS
PUMPOUT
RADIO
SEAWATER WASH DOWN
SHOWER SUMP PUMP
SSB
STERN LIGHT
STROBE LIGHT
TRICOLOR LIGHT
TROLLING MOTOR
WASHDOWN
WATER MAKER
WINCHES
WIPER PORT
WIPER STBD

4207 and 8039

(BLANK)
12 VOLT DC
12 VOLT DC OUTLETS
AFT CABIN
AFT HEAD
ALARM SYSTEM
ANCHOR WASH DOWN
BAIT PUMP
BILGE ALARM
BILGE PUMP 2
BRIDGE INSTRUMENTS
CABIN 2 LIGHTS
CABIN 3 LIGHTS
CABIN 4 LIGHTS
CABIN FANS
CABIN LIGHTS
CABIN LIGHTS
CB RADIO
CELLULAR PHONE
CHART LIGHT
CHART PLOTTER
COCKPIT LIGHTS
COLOR SOUNDER
COMM ELECTRONICS
DC LIGHTS
DC MAIN
DC OUTLETS
DC REFRIGERATOR
DC SUB PANEL
DECK LIGHTS
DECK LIGHTS AFT

DECK LIGHTS FWD
DEPTH RECORDER
DEPTH/SPEED
DESALINATOR
DIMMER
DINING AREA LIGHTS
DOCKING LIGHTS
EMERGENCY LIGHTS
ENGINE ROOM BILGE ALARM
ENGINE ROOM BLOWERS
ENGINE ROOM PANEL MAIN
ENGINE ALARM
EXTERIOR LIGHTS
FAN 2
FIRE ALARM
FISHING LIGHT
FLOOD LIGHTS
FLYBRIDGE ELECTRONICS
FLYBRIDGE LIGHTS
FRESH WATER PUMP
FRESH WATER WASH DOWN
GALLEY LIGHTS
GPS/PLOTTER
HAILER
HAM RADIO
HEAD
HEAD LIGHTS
HEAD LIGHTS 2
HEATER 2
HELM ELECTRONICS

HELM GAUGES
HELM INSTRUMENTS
HIGH WATER ALARM
HOLDING TANK
HOLDING TANK ALARM
HOLDING TANK PUMP
INSTRUMENT LIGHTS
INSTRUMENTS
INTERCOM
INTERIOR LIGHTS
LIGHTS 2
LIVWELL
LOG
LORAN
MAIN CABIN
MAP LIGHT
MAST LIGHTS
NAV STATION ELECTRONICS
NAV STATION GAUGES
NAV STATION INSTRUMENTS
NAV STATION LIGHTS
NAVIGATION ELECTRONICS
NAVIGATION INSTRUMENTS
NAVIGATION LIGHTS
RACK LIGHTS
RADIO
SALOON
SALOON LIGHTS
SAT/COM
SAT/NAV

SATELLITE DISH
SEARCHLIGHT
SEAWATER TEMP
SEAWATER WASH DOWN
SECURITY SYSTEM
SHOWER SUMP PUMP
SONAR
SPEED/LOG
SSB
SUB PANEL
SUMP PUMP
TELEPHONE SYSTEM
TRACK LIGHTS
TRANSFER PUMP
TRIM TABS
TV
TV/VCR
UTILITY
VIDEO PLOTTER
WATER ALARM
WATER MAKER
WATER PUMP
WEATHER FAX
WEATHER INSTRUMENT
WINCHES
WIND INSTRUMENTS
WINDEX LIGHT
WIPER PORT
WIPER STBD
WIPERS

4205 and 8030

ACCESSORY
ANCHOR LIGHT
AUTOPILOT
BILGE PUMP
BLOWER
COMPASS LIGHT
DEPTH SOUNDER
ELECTRONICS
ENGINE INSTRUMENTS
FAN
FOREDECK LIGHT
FWD CABIN LIGHTS
GPS
HORN
KNOTMETER
LIGHTS
MACERATOR PUMP
MAIN CABIN LIGHTS
RADAR
REFRIGERATOR
RUNNING LIGHTS
SAILING INSTRUMENTS
SPARE
SPREADER LIGHTS
STEAMING LIGHT
STEREO
STROBE LIGHT
TRICOLOR LIGHT
VHF
WATER PRESSURE

4208 and 8067

(BLANK)
120 VOLT AC OUTLETS
120 VOLTS AC / 60 HZ
AC COMPRESSOR
AC FAN
AC MAIN
AC PANEL
AC POWER
AC REFRIGERATOR
AC SUB PANEL
AFT CABIN
AFT HEAD
AIR CONDITIONER 3
AIR CONDITIONER 4
ALARM SYSTEM
AMPLIFIER
AUDIO/VIDEO SYSTEM
BATTERY CHARGER 2
BRIDGE LIGHTS
BRIDGE OUTLETS
CABIN
CABIN 2
CABIN 2 LIGHTS
CABIN 2 OUTLETS
CABIN 3
CABIN 3 LIGHTS
CABIN 3 OUTLETS
CABIN 4
CABIN 4 LIGHTS
CABIN 4 OUTLETS

CABIN HEATER
CABIN LIGHTS
CHARGER/INVERTER
COCKPIT LIGHTS
COCKPIT REFRIGERATOR
COMPARTMENT LIGHT
COOKTOP
DECK LIGHTS
DIMMER
DINING AREA LIGHTS
DINING AREA OUTLETS
DISHWASHER
DISPOSAL
DRYER
EMERGENCY LIGHTS
ENGINE ROOM LIGHTS
ENGINE ROOM OUTLETS
EXHAUST FAN
EXTERIOR LIGHTS
FAN
FAN 2
FAN 3
FAN 4
FLOOD LIGHTS
FREEZER
FURNACE
GALLEY APPLIANCES
GALLEY LIGHTS
GARBAGE DISPOSAL
GENERATOR 1

GFI OUTLET
HALLWAY LIGHTS
HEAD 2 OUTLETS
HEAD 3 OUTLETS
HEAD 4 OUTLETS
HEAD LIGHTS
HEAD LIGHTS 2
HEAD LIGHTS 3
HEAD LIGHTS 4
HEAD OUTLETS
HEADLIGHTS
HEATER 2
HEATER 3
HEATER 4
HOOD FAN
ICEMAKER
INTERIOR LIGHTS
INVERTER OUTLET
ISOLATION TRANSFORMER
LAZARETTE LIGHTS
LECTRASAN
LIGHTS 2
LIGHTS 3
LIGHTS 4
LIGHTS AFT
LIGHTS FWD
MAIN
MAIN BREAKER
MAIN CABIN
NAV STATION LIGHTS

OUTLETS 2
OUTLETS 3
OUTLETS 4
OUTLETS DECK
OUTLETS EXTERIOR
OUTLETS INTERIOR
RACK OUTLETS
RANGE
REFRIGERATOR/FREEZER
REVERSE POLARITY
SALOON
SALOON HEATER
SALOON LIGHTS
SALOON OUTLETS
SATELLITE DISH
SHIP
SHORE
SHORE POWER
STEREO
STOVE/MICROWAVE
SUB PANEL
TELEPHONE SYSTEM
TRACK LIGHTS
TRASH COMPACTOR
TV
UPS SYSTEM
VACUUM
VIDEO SYSTEM
WASHER
WATER MAKER

Label set included with Source Selection Panels (not sold separately)
Blank WRITE-ON
INVERTER
SHORE
SHORE 1
SHORE 2
AC BUS 1
AC BUS 2
GENERATOR
GENERATOR 1
GENERATOR 2

Individual Square and Large Format Panel Labels

To order individual labels, please indicate the Part # (6520 or 8063) and the Label No.

Label Part #	Label Text	Label Part #	Label Text	Label Part #	Label Text	Label Part #	Label Text
0001	LABEL #1	0485	BEDROOM SLIDEOUT	0125	DECK LIGHTS AFT	0189	FISHING LIGHT
0002	LABEL #2	0055	BILGE	0126	DECK LIGHTS FWD	0487	FISHWELL PUMP
0003	(BLANK)	0056	BILGE ALARM	0127	DECK LIGHTS PORT	0488	FISHWELL PUMP 2
0005	12 VOLT DC	0057	BILGE ALARM 2	0128	DECK LIGHTS STBD	0576	FLOAT SWITCH
0004	12 VOLT DC OUTLETS	0058	BILGE ALARM 3	0129	DEFROSTER	0190	FLOOD LIGHTS
0499	12 VOLT OUTLETS INSIDE	0059	BILGE ALARM 4	0130	DEPTH RECORDER	0191	FLOSCAN
0500	12 VOLT OUTLETS OUTSIDE	0060	BILGE LIGHTS	0131	DEPTH SOUNDER	0192	FLYBRIDGE
0502	120 VOLT / 60 HZ SHORE POWER	0061	BILGE PUMP	0132	DEPTH/SPEED	0193	FLYBRIDGE ELECTRONICS
0007	120 VOLT AC / 60 HZ	0062	BILGE PUMP 2	0133	DESALINATOR	0194	FLYBRIDGE LIGHTS
0006	120 VOLT AC OUTLETS	0063	BILGE PUMP 3	0134	DIMMER	0195	FLYBRIDGE OUTLETS
0516	120/240V 60 HZ	0064	BILGE PUMP 4	0135	DINING AREA LIGHTS	0196	FOG LIGHTS
0517	120/240V 60 HZ SHORE POWER	0453	BILGE PUMP ON-OFF-AUTO	0136	DINING AREA OUTLETS	0197	FOREDECK LIGHT
0526	230 VOLTS AC 50 HZ	0559	BLANK WHITE WRITABLE	0137	DISCHARGE PUMP	0539	FORWARD BILGE
0010	24 VOLT DC	0065	BLOWER	0567	DISCHARGE PUMP 2	0198	FREEZER
0009	24 VOLT DC OUTLET	0066	BOAT DAVIT	0568	DISCHARGE PUMP 3	0199	FRESH WATER
0008	240 VOLTS AC	0067	BOOM LIGHT	0138	DISHWASHER	0200	FRESH WATER PUMP
0460	240 VOLTS AC / 60 HZ	0068	BOW LIGHT	0139	DISPOSAL	0201	FRESH WATER PUMP 2
0515	250 VOLT 50HZ SHORE POWER	0069	BOW THRUSTER	0140	DIVE COMPRESSOR	0202	FRESH WATER PUMP 3
0468	250 VOLTS AC / 50 HZ	0070	BRIDGE	0141	DOCKING LIGHT PORT	0203	FRESH WATER PUMP 4
0462	AC BUS 1	0071	BRIDGE INSTRUMENTS	0142	DOCKING LIGHT STBD	0204	FRESH WATER WASH DOWN
0011	AC COMPRESSOR	0072	BRIDGE LIGHTS	0143	DOCKING LIGHTS	0482	FRONT SLIDEOUT
0012	AC FAN	0073	BRIDGE OUTLETS	0144	DOWN RIGGER	0561	FUEL GAUGE
0013	AC MAIN	0074	CABIN	0145	DRYER	0205	FUEL PRIMER PUMP
0014	AC PANEL	0075	CABIN 2	0146	DUMP VALVES	0206	FUEL PUMP
0015	AC POWER	0501	CABIN 2 FAN	0566	ECU	0207	FUEL PUMP 2
0016	AC REFRIGERATOR	0076	CABIN 2 LIGHTS	0580	ELCI	0208	FUEL PUMP 3
0017	AC SUB PANEL	0077	CABIN 2 OUTLETS	0147	ELECTRIC HATCH	0209	FUEL PUMP 4
0532	ACCENT LIGHT	0078	CABIN 3	0469	ELECTRONIC CONTROL UNIT	0210	FUEL TANK HEATER
0018	ACCESSORY	0079	CABIN 3 LIGHTS	0148	ELECTRONICS	0211	FUEL TRANSFER
0019	ADF	0080	CABIN 3 OUTLETS	0149	EMERGENCY BACKUP SYS	0507	FUME DETECTOR
0020	AERATOR	0081	CABIN 4	0150	EMERGENCY LIGHTS	0212	FURLER JIB
0021	AFT CABIN	0082	CABIN 4 LIGHTS	0151	EMERGENCY PUMPS	0213	FURLER MAINSAIL
0022	AFT CABIN LIGHTS	0083	CABIN 4 OUTLETS	0545	ENGINE	0214	FURLER SPINNAKER
0023	AFT CABIN OUTLETS	0084	CABIN FAN	0581	ENGINE 1	0215	FURNACE
0536	AFT CABIN SUMP	0085	CABIN HEATER	0582	ENGINE 2	0216	FWD CABIN
0530	AFT DISCHARGE PUMP	0086	CABIN LIGHTS	0547	ENG 1/ENG 2	0217	FWD CABIN LIGHTS
0024	AFT HEAD	0087	CABIN OUTLETS	0158	ENGINE ALARM	0218	FWD CABIN OUTLETS
0025	AIR COMPRESSOR	0088	CABLEMASTER	0159	ENGINE BLOCK HEATER	0529	FWD DISCHARGE PUMP
0026	AIR CONDITIONER	0089	CASSETTE PLAYER	0160	ENGINE CONTROL PORT	0528	FWD HEAD
0027	AIR CONDITIONER 2	0090	CB RADIO	0161	ENGINE CONTROL STBD	0219	GALLEY
0028	AIR CONDITIONER 3	0091	CCTV	0162	ENGINE CONTROLS	0220	GALLEY APPLIANCES
0029	AIR CONDITIONER 4	0092	CD PLAYER	0163	ENGINE DRIVEN REFRIG	0221	GALLEY DRAIN
0030	AIR CONDITIONER PUMP	0093	CELLULAR PHONE	0164	ENGINE EXHAUST FAN	0222	GALLEY FAN
0031	AIR HORN	0537	CENTER LIVEWELL	0165	ENGINE HATCH	0223	GALLEY LIGHTS
0573	AIS	0094	CHARGER/INVERTER	0166	ENGINE HEATER PORT	0224	GALLEY OUTLETS
0544	ALARM	0095	CHART LIGHT	0167	ENGINE HEATER STBD	0490	GALVANIC ISOLATOR
0032	ALARM SYSTEM	0096	CHART PLOTTER	0168	ENGINE INSTRUMENTS	0225	GARBAGE DISPOSAL
0461	ALTERNATOR	0097	CHOKE	0169	ENGINE OIL PAN PUMP	0226	GAS ALARM
0033	ALTERNATOR DISCONNECT	0098	CIRCULATOR PUMP	0152	ENGINE ROOM BILGE ALARM	0227	GENERAL PURPOSE
0034	AMPLIFIER	0508	CLOCK	0153	ENGINE ROOM BLOWER	0523	GENERATOR
0035	ANCHOR LIGHT	0099	CLOSET LIGHT	0154	ENGINE ROOM HEATER	0228	GENERATOR 1
0036	ANCHOR LIGHT MAIN	0575	CO DETECTOR	0155	ENGINE ROOM LIGHTS	0229	GENERATOR 2
0037	ANCHOR LIGHT MIZZEN	0100	COCKPIT LIGHTS	0156	ENGINE ROOM OUTLETS	0454	GENERATOR OFF ON START
0038	ANCHOR WASH DOWN	0101	COCKPIT REFRIG	0157	ENGINE ROOM PANEL MAIN	0230	GENERATOR ROOM BLOWER
0039	APPLIANCES	0102	COLOR SOUNDER	0170	ENGINE SHUTDOWN	0466	GENERATOR RUNNING
0040	ARCH LIGHTS	0103	COMM ELECTRONICS	0171	ENGINE TEMP	0455	GENERATOR STOP
0041	AUDIO/VIDEO SYSTEM	0104	COMPARTMENT HEATER	0546	ENGINES	0578	GFCI
0525	AUTO FILL	0105	COMPARTMENT LIGHT	0172	ENTERTAINMENT CENTER	0231	GFI OUTLET
0042	AUTO/MANUAL	0106	COMPASS LIGHT	0173	ENTRANCE DOOR	0232	GPS
0555	AUTO/MAN	0107	COMPUTER	0174	ENTRY STEP	0233	GPS/LORAN
0524	AUTOMATIC CHARGING RELAY	0514	COMPUTER DISPLAY	0175	EXHAUST FAN	0234	GPS/PLOTTER
0043	AUTOPILOT	0108	CONDENSER PUMP	0176	EXHAUST TEMP	0510	GUN LOCKS
0044	BAIT PUMP	0109	CONSOLE LIGHT	0177	EXTERIOR	0235	GYRO COMPASS
0045	BAITWELL	0110	CONVERTER	0178	EXTERIOR LIGHTS	0236	HAILER
0046	BALLAST CONTROLS	0111	COOKING GRILL	0179	FAN	0237	HALLWAY LIGHTS
0047	BALLAST PUMP	0112	COOKTOP	0180	FAN 2	0238	HALON FIRE SYSTEM
0048	BAR	0113	COOLING PUMP	0181	FAN 3	0239	HAM RADIO
0481	BATHROOM	0114	COURTESY LIGHTS	0182	FAN 4	0240	HEAD
0049	BATTERY	0115	CREW LIGHTS	0183	FAX	0241	HEAD 2
0473	BATTERY 1	0116	CREW QUARTERS	0184	FILLING PUMP	0242	HEAD 2 FAN
0474	BATTERY 2	0117	DAVIT	0185	FIRE ALARM	0243	HEAD 2 OUTLETS
0050	BATTERY CHARGER	0118	DC LIGHTS	0186	FIRE EXT	0244	HEAD 3
0051	BATTERY CHARGER 2	0119	DC MAIN	0187	FIRE HORN	0245	HEAD 3 FAN
0052	BATTERY COMPARTMENT	0120	DC OUTLETS	0459	FISH FINDER	0246	HEAD 3 OUTLETS
0053	BATTERY PARALLEL	0121	DC REFRIGERATOR	0538	FISHBOX DRAIN	0247	HEAD 4
0560	BATTERY SWITCH	0122	DC SUB PANEL	0188	FISHBOX ICEMAKER	0248	HEAD 4 FAN
0054	BEACON	0123	DECK	0520	FISHBOX PUMP	0249	HEAD 4 OUTLETS
0480	BEDROOM	0124	DECK LIGHTS	0521	FISHBOX REFRIGERATOR	0250	HEAD FAN

Example:

Square Format
6520-0044



Large Format
8063-0356

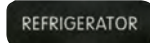

Label Part #	Label Text	Label Part #	Label Text	Label Part #	Label Text	Label Part #	Label Text
0251	HEAD LIGHTS	0311	MAIN CABIN	0367	SALOON LIGHTS	0429	VACUUM
0252	HEAD LIGHTS 2	0312	MAIN CABIN LIGHTS	0368	SALOON OUTLETS	0430	VACUUM PUMP
0253	HEAD LIGHTS 3	0313	MAIN CABIN OUTLETS	0369	SALT WATER PUMP	0431	VCR
0254	HEAD LIGHTS 4	0314	MAIN SAIL FURLING	0370	SAT/COM	0432	VHF
0255	HEAD OUTLETS	0315	MAP LIGHT	0371	SAT/NAV	0511	VHF 1
0256	HEADLIGHTS	0572	MARINE SANITATION DEVICE	0372	SATELLITE DISH	0512	VHF 2
0257	HEATER	0316	MAST LIGHTS	0373	SCRUBBER	0433	VIDEO PLOTTER
0519	HEATER & AIR CONDITIONER	0317	MASTHEAD LIGHT	0374	SEARCHLIGHT	0434	VIDEO SYSTEM
0258	HEATER 2	0551	MEMORY	0375	SEARCHLIGHT HAND HELD	0543	WASHDOWN
0259	HEATER 3	0574	MERCATHODE	0376	SEARCHLIGHT REMOTE	0513	WASHDOWN PUMP
0260	HEATER 4	0318	MICROWAVE	0377	SEAWATER TEMP	0435	WASHER
0261	HELM ELECTRONICS	0319	MINI DISC PLAYER	0378	SEAWATER WASH DOWN	0436	WASHER/DRYER
0262	HELM GAUGES	0320	MIZZEN FLOOD	0379	SECURITY SYSTEM	0437	WATER ALARM
0263	HELM INSTRUMENTS	0456	NAV LIGHT ANCHOR OFF NAV	0380	SHIP	0562	WATER GAUGE
0264	HIGH WATER ALARM	0321	NAV STATION ELECTRONICS	0381	SHORE	0438	WATER HEATER
0265	HOLDING TANK	0322	NAV STATION GAUGES	0463	SHORE 1	0439	WATER LEVEL
0266	HOLDING TANK ALARM	0323	NAV STATION INSTRUMENTS	0464	SHORE 2	0440	WATER MAKER
0267	HOLDING TANK PUMP	0324	NAV STATION LIGHTS	0382	SHORE CORD REEL	0441	WATER PRESSURE
0268	HOOD FAN	0325	NAVIGATION ELECTRONICS	0383	SHORE POWER	0442	WATER PUMP
0269	HOOD LIGHT	0326	NAVIGATION INSTRUMENTS	0384	SHORE POWER CORD	0443	WEATHER FAX
0270	HORN	0327	NAVIGATION LIGHTS	0385	SHOWER SUMP PUMP	0444	WEATHER INSTRUMENT
0475	HOT TUB	0565	NETWORK	0386	SINK DRAIN	0571	WIFI
0271	HOT WATER PUMP	0328	NIGHT LIGHTS	0486	SLIDEOUT	0553	WINCH
0548	HOUSE	0329	OFF	0387	SOLAR PANEL	0445	WINCHES
0549	HOUSE/ENG	0331	OIL CHANGE PUMP	0388	SONAR	0477	WIND GENERATOR
0550	HOUSE/GEN	0563	OIL GAUGE	0542	SONAR/ACC	0446	WIND INSTRUMENTS
0272	HYDRAULIC ALARM	0332	ON	0389	SPARE	0522	WIND SHIELD VENT
0273	HYDRAULIC SYSTEM	0330	ON-OFF	0390	SPEED/LOG	0447	WINDEX LIGHT
0274	HYDRAULIC TANK ALARM	0333	OUTLETS	0391	SPREADER LIGHTS	0448	WINDLASS
0570	HYDRAULIC VALVE	0334	OUTLETS 2	0392	SPREADER LT MIZZEN	0449	WINDSHIELD WASHER
0275	ICE MAKER	0335	OUTLETS 3	0393	SSB	0472	WIPER CENTER
0276	IGNITION	0336	OUTLETS 4	0394	STABILIZER	0450	WIPER PORT
0277	IGNITION PORT	0505	OUTLETS AFT	0558	STAIR LIGHT	0451	WIPER STBD
0278	IGNITION STBD	0337	OUTLETS DECK	0395	STARBOARD	0452	WIPERS
0279	INSTRUMENT LIGHTS	0506	OUTLETS ENGINE ROOM	0396	START	0557	WIRELESS
0280	INSTRUMENTS	0338	OUTLETS EXTERIOR	0398	START PORT		
0281	INTERCOM	0503	OUTLETS FORWARD	0399	START STBD		
0282	INTERCOM HAILER	0339	OUTLETS INTERIOR	0397	START-STOP		
0283	INTERCOM/TELEPHONE	0504	OUTLETS PILOT HOUSE	0541	STBD FISHBOX		
0284	INTERIOR LIGHTS	0458	PANEL LIGHTS	0533	STBD LIVEWELL		
0556	INTERNET	0496	PILOT HOUSE FAN	0400	STBD THRUSTER		
0285	INVERTER	0340	PORT	0401	STEAMING LIGHT		
0467	INVERTER 2	0540	PORT FISHBOX	0569	STEERING VALVE		
0476	INVERTER AC BUS	0534	PORT LIVEWELL	0402	STEP LIGHT		
0471	INVERTER AC SUPPLY	0341	PORT THRUSTER	0403	STEREO		
0470	INVERTER DC SUPPLY	0552	PORT/STBD ENG	0577	STEREO MEMORY		
0286	INVERTER OUTLET	0342	POWER	0404	STERN LIGHT		
0287	ISOLATION TRANSFORMER	0343	POWER WASHER	0509	STERN THRUSTER		
0479	KITCHEN	0457	PRE-HEAT	0405	STOP		
0484	KITCHEN SLIDEOUT	0344	PRIMARY WINCHES	0406	STOVE		
0288	KNOTMETER	0345	PRINTER	0407	STOVE/MICROWAVE		
0289	LAZARETTE LIGHTS	0346	PUMP	0408	STROBE LIGHT		
0290	LECTRASAN	0497	PUMP BLACK WATER	0409	SUB PANEL		
0291	LIGHTER	0498	PUMP GRAY WATER	0410	SUMP PUMP		
0292	LIGHTS	0554	PUMPOUT	0411	SUMP PUMP 2		
0293	LIGHTS 2	0347	RACK LIGHTS	0412	SYNCHRO		
0294	LIGHTS 3	0348	RACK OUTLETS	0564	TANK GAUGE		
0295	LIGHTS 4	0349	RADAR	0413	TAPE DECK		
0296	LIGHTS AFT	0350	RADAR ARCH LIGHTS	0414	TELEPHONE SYSTEM		
0494	LIGHTS AFT CABIN	0351	RADIO	0415	TEST		
0297	LIGHTS FWD	0352	RANGE	0416	TOWING LIGHTS		
0493	LIGHTS MASTER CABIN	0579	RCBO	0417	TRACK LIGHTS		
0495	LIGHTS PANTRY	0353	RDF	0465	TRANSFER		
0492	LIGHTS PILOTHOUSE	0483	REAR SLIDEOUT	0418	TRANSFER PUMP		
0298	LIGHTS PORT	0354	RECEIVER	0419	TRANSFORMER		
0491	LIGHTS SETTEE	0355	RECEPTACLE	0518	TRANSFORMER SECONDARY		
0299	LIGHTS STBD	0356	REFRIGERATOR	0420	TRASH COMPACTOR		
0300	LIVEWELL	0357	REFRIGERATOR PUMP	0478	TRAVEL LOCKS		
0301	LIVEWELL INPUT	0358	REFRIGERATOR/FREEZER	0421	TRICOLOR LIGHT		
0302	LIVEWELL OUTPUT	0359	REGULATOR	0422	TRIM TABS		
0303	LOCKER LIGHTS	0360	REVERSE POLARITY	0527	TROLLING MOTOR		
0304	LOG	0361	ROD LOCKER	0423	TV		
0305	LORAN	0489	RUDDER ANGLE INDICATOR	0424	TV ANTENNA		
0306	LPG CONTROL	0362	RUNNING LIGHTS	0425	TV/STEREO		
0307	LUBE OIL PUMP	0363	SAILING CONTROLS	0426	TV/VCR		
0308	MACERATOR PUMP	0364	SAILING INSTRUMENTS	0535	UNDERWATER LIGHT		
0309	MAIN	0365	SALOON	0427	UPS SYSTEM		
0310	MAIN BREAKER	0366	SALOON HEATER	0428	UTILITY		

Emergency Vehicle Label Set

For emergency vehicles

- 180 Reinforced, waterproof labels
- Used on all ST-Blade Fuse Blocks

Part #	Color	Quantity
7870	Black	180 Labels

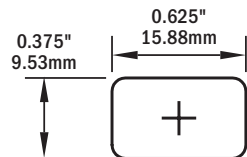

Related Products



ST-Blade Fuse Blocks
pages page 64-69



Circuit Identification Label Kit

Used on Blue Sea Systems Battery Switches

- Reinforced, waterproof labels
- Used on M-Series, E-Series, and HD-Series Battery Switches (p. 32-37)

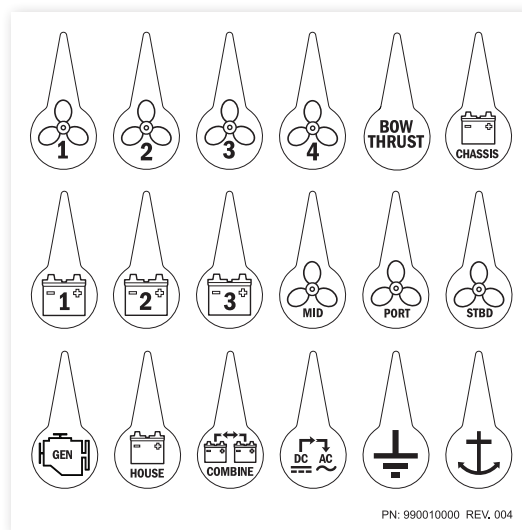

PN: 990010000 REV. 004

Part #	Description
7902	Circuit Identification Label Kit

Labels Included

ON/OFF	FLASH LIGHT	LIGHT 2	RIGHT DOME
12V SOCKET	FLOOD	LOAD SHED	RIGHT FLOOD
12V SOCKET 1	FOG	LOCK	RIGHT SCENE
12V SOCKET 2	FRONT	LOW POWER	RISER
A/H	FRONT CUT	LOWER	RMBLR
AIR COMP	FRONT FLASH	LVD	ROT
AIR HORN	FRONT FLOOD	MAN	SCENE
AIREL	FRONT ILS	MAP LIGHT	SCENE LIGHT
ALARM	FRONT LT BAR	MDC	SEARCH LIGHT
ALLEY LIGHTS	FRONT OSC	MESSAGE BOARD	SEC
ALPR	FRONT ROT	MODEM	SIDE
AMBER	FRONT STROBE	MONITOR	SLOW SPEED
AMP METER	GREEN	MONITOR 1	SM
AREA	GRILL	MONITOR 2	SPOT
AUX	GUN LOCK	OSC	START STOP
AUX 1	HAND-HELD	PA	STEP
AUX 2	HAZARD	PATIENT DOME	STROBE
AUX 3	HEADLT FLASH	PERIMETER	SUCTION ON/OFF
BACK UP	HEAT	PERIMETER 1	SURE EJECT
BLUE	HEAT/AC ON/OFF	PERIMETER 2	TAIL
BOX	HEAT/AC SELECT	PRIM	TAKE DOWN
BRAKE	HI-IDL	PRIORITY	TAP II
CAB	HI-LOW	PURSUIT	TCL
CABINET LIGHTS	HORN	Q SIR	TEMP METER
CAMERA 1	HORN 1	RADAR	THERMAL CAMERA
CAMERA 2	HORN SIREN	RADIO	TIMER
CENTER	IGN RELAY	RADIO 1	TOPE
CLEAR	INFRARED	RADIO 2	TOW
COMPUTER	INTER	RADIO 3	TRAFFIC
COOL	JOG	RADIO CHARGER	TRUNK
CORNER	JOG LEFT	RAPID FLASH	UPPER
CORNER STROBE	JOG RIGHT	REAR	USB
CRUISE	LED	REAR CUT	USB 1
DECK	LED 1	REAR FLASH	USB 2
DIM	LED 2	REAR FLOOD	USB 3
DIRECTNL ARROW	LED 3	REAR ILS	VIDEO
DOME	LED 4	REAR OSC	VIDEO CAMERA
DOME HI/LOW	LEFT	REAR SCENE	VOLT METER
DOME LIGHT	LEFT ALLEY	REAR STROBE	WAIL
DOOR	LEFT ARROW	RED	WARN
EMERG	LEFT DOME	RELAY	WARNING
EXHAUST VENT	LEFT FLOOD	RESET	WHT LT CUT
FAN HI/LOW	LEFT SCENE	RIGHT	WIG WAG
FAST	LIGHT	RIGHT ALLEY	WORK
FLASH	LIGHT 1	RIGHT ARROW	YELP

Protect Your Boat

with the correct size wire and fuse



Scan to download the app or go to www.circuitwizard.bluesease.com

1. Choose the Correct Wire

a) Locate the CURRENT FLOW IN AMPS of your circuit

b) Select the CIRCUIT TYPE

- Non-critical circuits with 10% allowable voltage drop include: general lighting, windlasses, bait pumps, general appliances
- Critical circuits with 3% allowable voltage drop include: panel main feeders, bilge blowers, electronics, navigation lights

c) Find the CIRCUIT LENGTH

The circuit length is the length of the negative wire added to the length of the positive wire.

Calculations are based on 105°C wire. For wire rated at 90°C or lower, or for wire that passes through an engine room, the first row of the chart does not apply.

d) Intersect the CURRENT FLOW IN AMPS with CIRCUIT LENGTH to identify the correct wire size

Example: A windlass rated 80A is 25 ft. from the battery. The circuit length is the total length of the positive and negative wire added together, which in this example is 50 ft. The circuit type is 'non-critical', and the correct wire size is 4 AWG.

Calculations are based on 105°C wire. For more detailed calculations, download the Circuit Wizard app or go to circuitwizard.bluesease.com

WIRE SELECTION CHART

Standard and Metric Wire Comparison Table	CIRCUIT TYPE		CURRENT FLOW IN AMPS															
	10% VOLTAGE DROP Non Critical	3% VOLTAGE DROP Critical	5A	10A	15A	20A	25A	30A	40A	50A	60A	70A	80A	90A	100A	120A	150A	200A
	0 to 20 ft. (0 to 6.1 M)	0 to 6 ft. (0 to 1.8 M)		16 AWG	14 AWG	12 AWG	10 AWG	8 AWG	6 AWG	4 AWG	2 AWG	0 AWG	2 0 AWG	3 0 AWG	4 0 AWG			
30 ft. (9.1 M)	10 ft. (3.0 M)	16 AWG	14 AWG	12 AWG	10 AWG	8 AWG	6 AWG	4 AWG	2 AWG	0 AWG	2 0 AWG	3 0 AWG	4 0 AWG					
50 ft. (15.2 M)	15 ft. (4.6 M)	14 AWG	12 AWG	10 AWG	8 AWG	6 AWG	4 AWG	2 AWG	0 AWG	2 0 AWG	3 0 AWG	4 0 AWG						
65 ft. (19.8 M)	20 ft. (6.1 M)	12 AWG	10 AWG	8 AWG	6 AWG	4 AWG	2 AWG	0 AWG	2 0 AWG	3 0 AWG	4 0 AWG							
80 ft. (24.4 M)	25 ft. (7.6 M)	10 AWG	8 AWG	6 AWG	4 AWG	2 AWG	0 AWG	2 0 AWG	3 0 AWG	4 0 AWG								
100 ft. (30.5 M)	30 ft. (9.1 M)	8 AWG	6 AWG	4 AWG	2 AWG	0 AWG	2 0 AWG	3 0 AWG	4 0 AWG									
130 ft. (39.6 M)	40 ft. (12.2 M)	6 AWG	4 AWG	2 AWG	0 AWG	2 0 AWG	3 0 AWG	4 0 AWG										
165 ft. (50.3 M)	50 ft. (15.2 M)	4 AWG	2 AWG	0 AWG	2 0 AWG	3 0 AWG	4 0 AWG											
200 ft. (61.0 M)	60 ft. (18.3 M)	2 AWG	0 AWG	2 0 AWG	3 0 AWG	4 0 AWG												
-	70 ft. (21.3 M)	0 AWG	2 0 AWG	3 0 AWG	4 0 AWG													
-	80 ft. (24.4 M)	2 0 AWG	3 0 AWG	4 0 AWG														
-	90 ft. (27.4 M)	3 0 AWG	4 0 AWG															
-	100 ft. (30.5 M)	4 0 AWG																
-	110 ft. (33.5 M)																	
-	120 ft. (36.6 M)																	
-	130 ft. (39.6 M)																	

AWG WIRE SIZE CHART

Circles indicate actual diameter of wire (not including insulation)

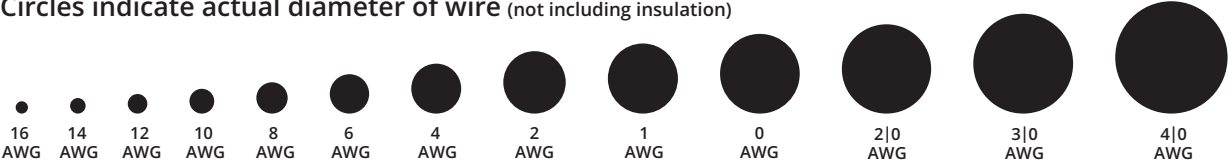

Although this process uses information from ABYC E-11 to recommend wire size and circuit protection, it may not cover all of the unique characteristics that may exist on a boat. If you have specific questions about your installation please consult an ABYC certified installer.

2. Choose the Correct Fuse and Fuse Amperage

a) Choose a fuse type by following the line of the AWG WIRE SIZE determined from the Wire Selection Chart

Appropriate fuses will have an amperage that intersects the AWG Wire Size line.

b) The appropriate fuse amperage will be found in one of the four gray bars below the fuse type

- Single Wire, Outside Engine Room = First column dark gray bar
- Single Wire, Inside Engine Room = First column light gray bar
- Bundled Wire, Outside Engine Room = Second column dark gray bar
- Bundled Wire, Inside Engine Room = Second column light gray bar

Example: For a 4 AWG single 105°C rated wire outside an engine room, the maximum fuse amperage is 150A.

Note:

Possible fuse amperages for a circuit can fall between a range of maximum and minimum fuse amperages. The procedure in step 1 calculates the maximum fuse amperage which reduces nuisance blows but may offer less protection than a lower amperage fuse.

The minimum fuse amperage is calculated by multiplying the current flow in amps by 125%.

If the product instructions specify a fuse amperage, use that value if it is under the maximum amperage found in the step 1 procedure.

If the specified fuse amperage is over the maximum suggested, move down the column and choose the wire size that intersects with the specified fuse amperage.

Calculations are based on 105°C wire. For more detailed calculations, download the Circuit Wizard app or go to circuitwizard.blusea.com

FUSE SELECTION CHART

AWG WIRE SIZE	AGC® MDL® Fuse		ATO® or ATC® Fuse		MAXI® Fuse		AMI® or MIDI® Fuse		MRBF® Terminal Fuse		MEGA® or AMG® Fuse		CLASS T Fuse		CLASS T Fuse		ANL® Fuse		
	SINGLE WIRE	BUNDLED WIRES	SINGLE WIRE	BUNDLED WIRES	SINGLE WIRE	BUNDLED WIRES	SINGLE WIRE	BUNDLED WIRES	SINGLE WIRE	BUNDLED WIRES	SINGLE WIRE	BUNDLED WIRES	SINGLE WIRE	BUNDLED WIRES	SINGLE WIRE	BUNDLED WIRES	SINGLE WIRE	BUNDLED WIRES	
16 AWG	25A	20A	20A	15A															
14 AWG	30A	25A	20A	30A	30A	30A	30A	30A	30A	30A									
12 AWG	30A	25A	30A	25A	50A	40A	30A	50A	40A	30A									
10 AWG					60A	50A	40A	60A	50A	40A									
8 AWG					80A	70A	60A	80A	70A	60A									
6 AWG					80A	70A	125A	100A	80A	70A	125A	100A	80A	70A	125A	100A			
4 AWG					150A	125A	125A	100A	150A	125A	125A	100A	150A	125A	175A	150A	110A		
2 AWG					200A	175A	150A	125A	200A	175A	150A	125A	200A	175A	150A	125A	200A	175A	150A
1 AWG					200A	175A	150A	250A	200A	175A	150A	250A	200A	175A	150A	250A	200A	175A	150A
0 AWG					200A	175A	300A	250A	200A	175A	300A	250A	200A	175A	300A	250A	200A	175A	150A
2/0 AWG								300A	225A	200A	300A	225A	200A		200A	350A	300A	225A	200A
3/0 AWG									250A	225A				250A	400A	350A	250A	225A	200A
4/0 AWG									300A	250A				300A	400A	400A	300A	250A	200A

Fuse Scale Comparison

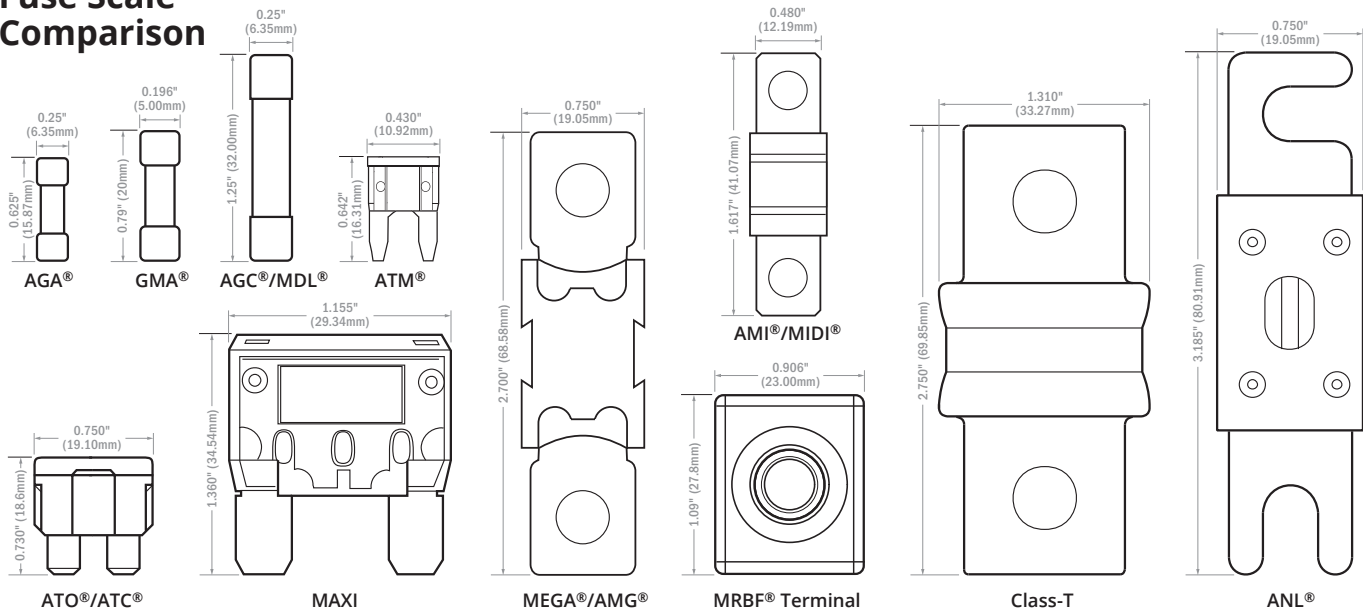

3. Choose the Fuse Holder

a) Using the fuse type chosen from the Fuse Selection Chart, follow the column down to find fuse holders or fuse blocks that meet your specific requirements

b) Consider environmental factors:

- Ignition protection is required where flammable vapors may accumulate

Example: Engine room and propane locker











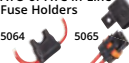
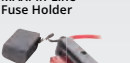

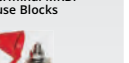
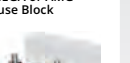

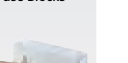

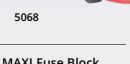

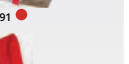
Consult American Boat and Yacht Council (ABYC) E-11.5.3 for Ignition Protection

- Ingress protection protects fuses from spray, washdown, and humidity. IP66-protected against powerful water jets

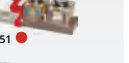
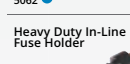

c) Decide between an in-line fuse holder or a fuse block:

- In-line fuse holders are compact and hold a single low-amperage fuse
- Fuse blocks mount to a solid surface and may hold a single fuse or multiple fuses

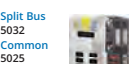
FUSE HOLDER SELECTION CHART

AGC® MDL®	ATO® or ATC® Fuse	MAXI® Fuse	AMI® or MIDI® Fuse	MRBF TERMINAL Fuse	MEGA® or AMG® Fuse	CLASS T Fuse 110A to 200A	CLASS T Fuse 225A to 400A	ANL® Fuse
Crimpable In-Line Fuse Holder  5060	ATO or ATC In-Line Fuse Holders  5064 ● 5065 ●	MAXI In-Line Fuse Holder  5068 ●	AMI or MIDI Safety Fuse Block  7720 ● ●	Terminal MRBF Fuse Blocks  5191 ●	MEGA or AMG Fuse Block  5001 ●	CLASS-T Fuse Block  5007100 ●	CLASS-T Fuse Block  5502 ●	ANL Fuse Blocks  5005 ●
Waterproof In-Line Fuse Holders  5061 ●	ST-Blade Fuse Blocks Water-Resistant  5056 ●	MAXI Fuse Block  5006100 ●	SafetyHub Fuse Blocks  7748 ● ●	 2151 ●	MEGA or AMG Safety Fuse Block  7721 ● ●		 5502100 ●	 5503 ●
Heavy Duty In-Line Fuse Holder  5062 ●	Battery Terminal Mount  5023 ●		 7725 ● ●	 5194 ●				
ST Glass Fuse Blocks  5015 ● 5018 ●	Compact Fuse Block  5045 ● 5046 ●			 5194 ●				
	Split Bus 5032 ● Common 5025 ● 5026 ● 5028 ● 5029 ● Independent 5035 ●			 5196 ●				
	SafetyHub Fuse Blocks  7748 ● ●							

Additional replacement fuses available from Blue Sea Systems:

 1A to 10A	 20A	 5A to 30A
---	---	---

LEGEND

- Ingress protection
- Ignition protection

Battery Management Wiring Schematics for Typical Applications

Batteries are at the heart of the electrical system found on any boat or vehicle. Proper battery management, including switching and charging, is essential for safe and reliable operation. The following wiring diagrams show how batteries, battery switches, and Automatic Charging Relays are wired together from a simple 1 battery - 1 engine configuration to a 4 battery - 2 engine - 1 generator system. For more detailed wiring guidelines please consult a qualified marine electrician or one of the many books available on the subject.

Note: The ACRs pictured are representative of any ACR. The battery switches are representative of any Battery Switch of the same model.

1 Battery - 1 Engine

Switches a single battery to a single load group.

ON-OFF Battery Switch

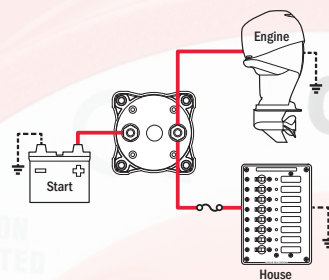

Saves battery power for starting.

1 ON-OFF Battery Switch
1 Low Voltage Disconnect

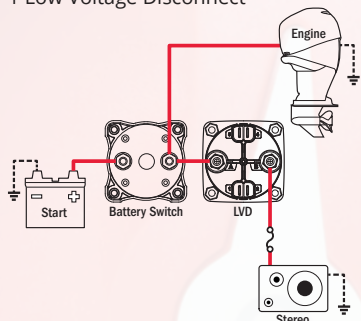

2 Battery - 1 Engine

Switches isolated battery banks to all loads or combines battery banks to all loads.

1 Selector Battery Switch
1 Automatic Charging Relay

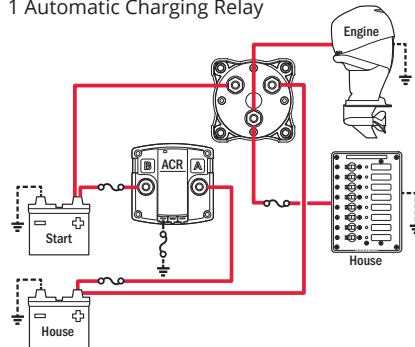

Note:
Uses same style batteries

Simultaneously switches two isolated battery banks or combines battery banks to all loads.

1 Dual Circuit Plus™ Battery Switch
1 Automatic Charging Relay

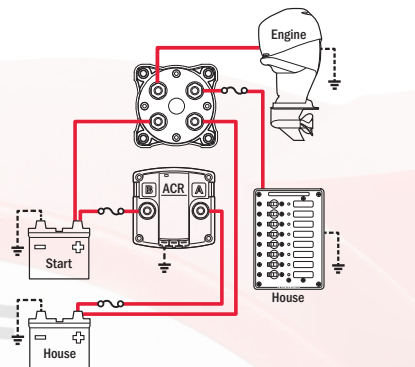

Can isolate a failed battery.

3 ON-OFF Battery Switches
1 Automatic Charging Relay

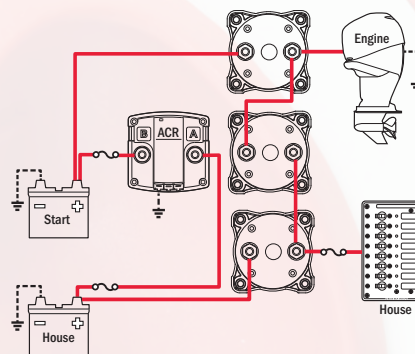

2 Battery - 2 Engine

House battery is shared with one engine. One engine battery is in reserve.

2 Selector Battery Switches
1 Automatic Charging Relay

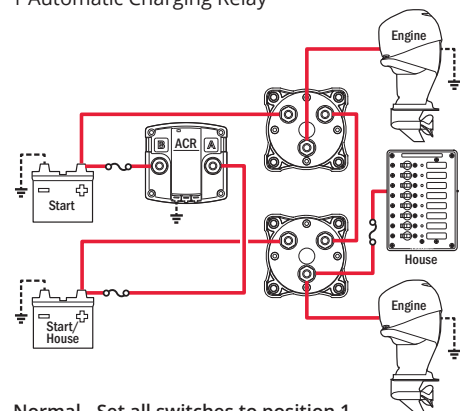

Normal - Set all switches to position 1
Parallel - Set all switches to position 1+2
Isolate - Set Load switch to position 2 and Source Switch to position 1+2

Engines share one battery. House battery is in reserve.

1 Dual Circuit Plus™ Battery Switch
1 Automatic Charging Relay

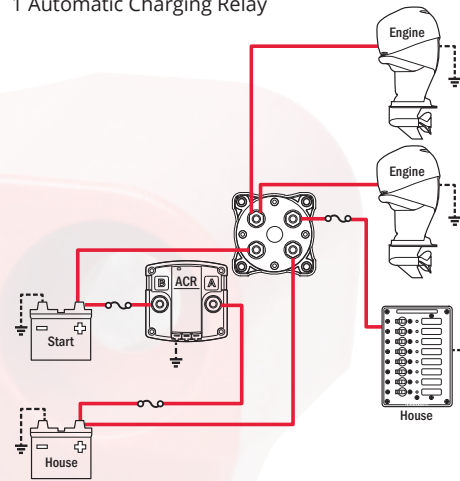

Can isolate a failed battery.

3 ON-OFF Battery Switches
1 Automatic Charging Relay

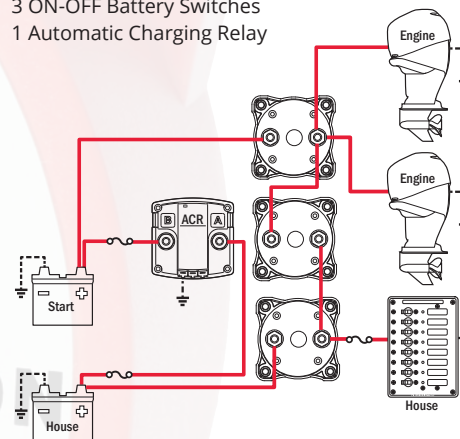

3 Battery - 2 Engine

Can isolate any battery source from any batteries.

- 3 Selector Battery Switches
- 2 Automatic Charging Relays

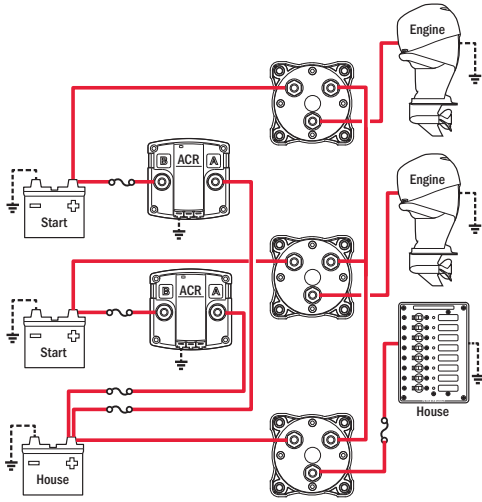

- Normal - Set all switches to position 1
- Parallel - Set all switches to position 1+2
- Isolate - Set Load switch to position 2 and Source Switch to position 1+2

Can parallel batteries for extra starting power.

- 2 Dual Circuit Plus™ Battery Switches
- 2 Automatic Charging Relays

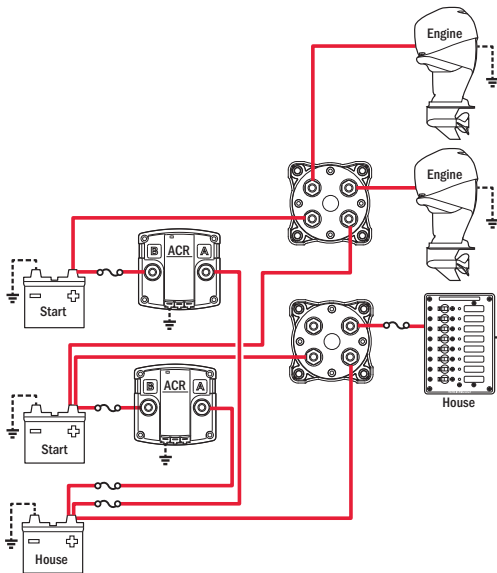

LEGEND

- DC Positive ———
- DC Ground - - - - -

4 Battery - 2 Engine - 1 Generator

Can isolate any battery source from any batteries.

- 4 Selector Battery Switches
- 3 Automatic Charging Relays

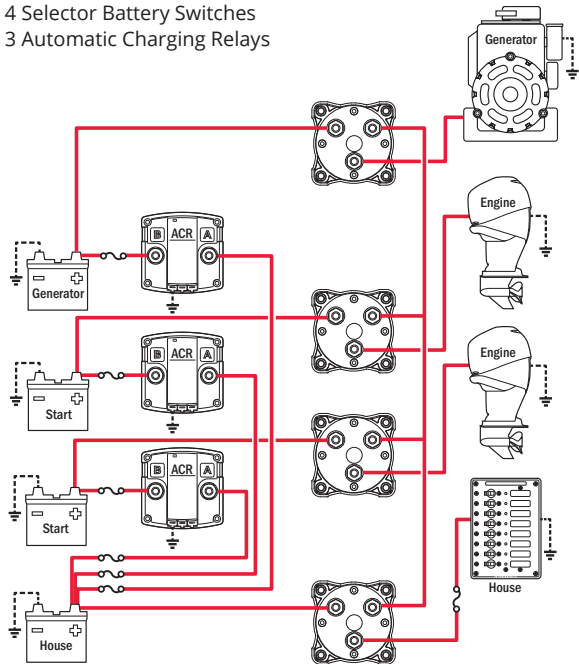

- Normal - Set all switches to position 1
- Parallel - Set all switches to position 1+2
- Isolate - Set Load switch to position 2 and Source Switch to position 1+2

Can parallel batteries for extra starting power.

- 3 Dual Circuit Plus™ Battery Switches
- 3 Automatic Charging Relays

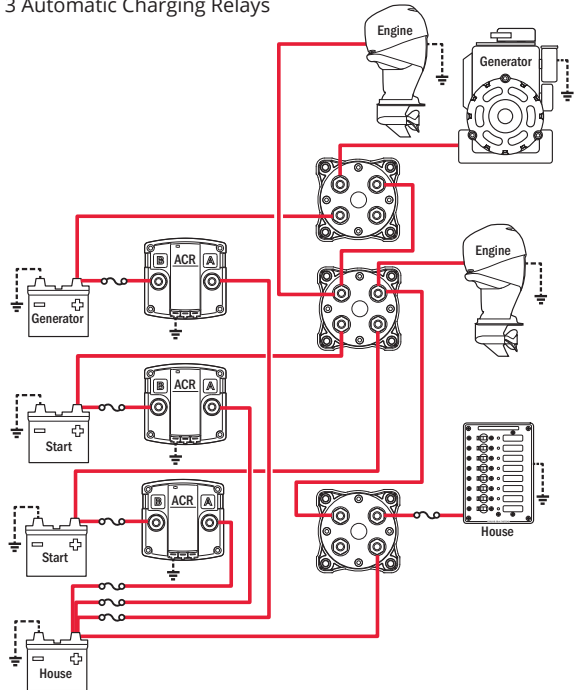

DC Main Circuit Protection and Branch Circuit Protection

Purpose

Fuses and circuit breakers are used to protect wire insulation from melting and starting fires in the event of overcurrents or short circuits which cause more amperage to flow in a wire than that wire is rated to carry. It is important to note that, except for those wires that are intended to carry starting currents, every positive wire in the DC Main Power Distribution System must be protected by a fuse or circuit breaker.

Considerations for DC Main Circuit Protection

Mounting Placement – distance from power source. The DC Main circuit protection system uses circuit breakers or fuses to protect the wires of the DC Main distribution system. The American Boat and Yacht Council (ABYC) publishes voluntary standards for the type and placement of the fuse or circuit breaker to be used as a DC Main circuit protection device. Wire intended to carry engine starting currents between the batteries, the switch, and the starter is not required to have main circuit protection devices installed. Maximum mounting placement dimensions for a fuse or circuit breaker are 7" if the conductor is not housed in a sheath or enclosure in addition to the wire insulation, 40" if the conductor is housed in a sheath or enclosure in addition to the wire insulation, and 72" if the conductor is connected directly to the battery and housed in a sheath or enclosure in addition to the wire insulation.



Selecting DC Main Circuit Protection

The principal attribute of a DC Main circuit protection device is its Ampere Interrupt Capacity (AIC) rating. Specifications listed in the ABYC standards determine the AIC a DC Main circuit protection device must have. The required AIC rating is determined by the total CCA of the batteries connected to the circuit. See the tables at right for the required AIC ratings.

Wire selection for DC applications on boats is usually based on voltage drop requirements. However, there is a maximum continuous current that the wire can withstand without overheating. Higher grade marine wires are rated for service up to 105°C (221°F)—the ABYC wire capacity table for 105°C is most frequently quoted. The 105°C table accurately reflects the capacity of single conductors exposed to freely circulating cooling air. However, other factors, such as covering bundles of wire in outer jackets to form a cable, or use of conduits or structural voids to protect wires, can reduce the cooling and reduce the safe capacity of the wire. A more conservative strategy is to use the 105°C wire, but treat it according to the 75°C table above when selecting circuit protection unless the wire is openly exposed for cooling.

See the Blue Sea Systems Circuit Wizard at circuitwizard.blueseasea.com or pages 161-163 for more assistance with wire and circuit protection selection.

ABYC Interrupt Rating Table

Total Connected Battery Cold Cranking Amperes (CCA) *	Ampere Interrupt Capacity	
12 VOLTS AND 24 VOLTS		
The white boxes identify two batteries, of the same size, placed in parallel configuration.	DC MAIN	DC BRANCH
 650 CCA or Less	1,500 AIC	750 AIC
 651–1,100 CCA	3,000 AIC	1,500 AIC
 Over 1,100 CCA	5,000 AIC	2,500 AIC
32 VOLTS		
1,250 CCA or Less	3,000 AIC	1,500 AIC
Over 1,250 CCA	5,000 AIC	2,500 AIC

* Battery cold cranking performance rating at -17.8°C (0°F): The discharge load in amps that a battery at -17.8°C (0°F) can deliver for 30 seconds, and maintain a voltage of 1.2 Volts per cell or higher, (e.g. 7.2 Volts for a 12 Volt battery). The CCA for the battery icons in this chart is an approximation and could be slightly higher or lower. Consult the battery manufacturer's specifications for precise CCA ratings. A battery rated in MCA will have a CCA capacity approximately 80% of MCA

ABYC E-11 requires the use of circuit breakers that can be required and reset and that they be applied as per the table above. The standard does not strictly require that fuses be applied in the same way, but it is an issue to consider, especially with high amp fuses used to protect panel feeders or inverters. Fuses under 10 Amp rating generally have such a high internal resistance they prevent fault currents from reaching 1000 Amps in 12 Volt circuits. The apparent contradiction when using these fuses for bilge pumps and other circuits directly off the battery is less of an issue than it might seem. If a fuse blows, and the case appears to be cracked or metal has been ejected, the fuse holder should be replaced.

ABYC Ampacity Rating Table at 30°C †

WIRE SIZE		TEMPERATURE RATING OF CONDUCTOR INSULATION									REFERENCE DATA					
Standard AWG	Metric mm ²	75°C			90°C			105°C			mm dia	Ohms /1000ft	Ohms /1000m			
		Eng Rm	Metric Rm	Eng Rm	Metric Rm	Eng Rm	Metric Rm	Eng Rm	Metric Rm							
18	0.75	9.5	7	19	15.5	19	16	6.6	5.0	13	11	13	11	0.98	7.29	23.92
	0.82	10	8	20	16	20	17	7	5	14	12	14	12	1.02	6.67	21.88
16	1.0	13	10	21	17	21	18	9	7	15	12	15	13	1.13	5.47	17.94
	1.3	15	11	25	21	25	21	11	8	18	14	18	15	1.29	4.17	13.70
14	1.5	16	12	24	20	29	24	11	9	17	14	20	17	1.38	3.65	11.96
	2.1	20	15	30	25	35	30	14	11	21	17	25	21	1.63	2.63	8.63
12	2.5	21	16	34	28	38	32	15	11	23	19	26	22	1.78	2.19	7.18
	3.3	25	19	40	33	45	38	18	13	28	23	32	27	2.05	1.65	5.42
10	4.0	34	25	46	38	51	43	24	18	32	27	35	30	2.26	1.37	4.49
	5.3	40	30	55	45	60	51	28	21	39	32	42	36	2.59	1.04	3.41
8	6.0	53	40	57	47	65	55	37	28	40	33	45	39	2.76	0.91	2.99
	8.4	65	49	70	57	80	68	46	34	49	40	56	48	3.27	0.65	2.14
6	10.0	79	60	84	69	100	85	56	42	59	48	70	60	3.6	0.55	1.79
	13.3	95	71	100	82	120	102	67	50	70	57	84	71	4.1	0.41	1.35
4	16.0	105	79	113	93	134	114	73	55	79	65	94	80	4.5	0.34	1.12
	21	125	94	135	111	160	136	88	66	95	78	112	95	5.2	0.26	0.85
3	25	141	106	150	123	175	148	99	74	105	86	122	104	5.6	0.22	0.72
	27	145	109	155	127	180	153	102	76	109	89	126	107	5.8	0.21	0.67
2	34	170	128	180	148	210	179	119	89	126	103	147	125	6.5	0.16	0.53
	35	173	130	186	153	217	185	121	91	130	107	152	129	6.7	0.16	0.51
1	42	195	146	210	172	245	208	137	102	147	121	172	146	7.3	0.13	0.42
	50	220	165	235	193	273	232	154	116	164	135	191	163	8.0	0.109	0.36
0	54	230	173	245	201	285	242	161	121	172	141	200	170	8.3	0.102	0.34
	68	265	199	285	234	330	281	186	139	200	164	231	196	9.3	0.081	0.27
00	70	274	206	292	239	341	289	192	144	204	168	238	203	9.4	0.078	0.26
	85	310	233	330	271	385	327	217	163	231	189	270	229	10.4	0.064	0.21
000	95	334	251	357	293	413	351	234	175	250	205	289	246	11.0	0.058	0.19
	107	360	270	385	316	445	378	252	189	270	221	312	265	11.7	0.051	0.17
0000	120	387	290	414	339	478	406	271	203	290	237	335	284	12.4	0.046	0.15
	150	445	333	476	390	550	467	311	233	333	273	385	327	13.8	0.036	0.12

Data based on E-11 Table VI-A (single conductors in free air) Data based on E-11 Table VI-B (Up to three conductors in a sheath, conduit or bundle)

SAE conductors are smaller than equivalent AWG by 5% to 12% with current capacity typically less by 7%. ISO Ratings for metric wire are slightly less than these values derived from ABYC VI-A ratings.

- For bundles of 4 to 6 conductors multiply by 0.857
- For bundles of 7 to 24 conductors multiply by 0.714
- For bundles of 25 or more, conductors multiply by 0.571

Wires counted in bundles need not include:

1. Wires carrying intermittent currents no more than rating per VI-A and for less than one minute per mm of diameter, and not repeating more often than a delay of 5X times active duration.
2. Wires carrying load currents at less than 50% of the wire rating per table VI-B.

† Thermally limited ampere capacity

AC Main Power Distribution and Circuit Protection

Purpose

- Provide a path for delivering power from the ship's sources of AC power to the AC branch distribution system
- Provide a path for returning fault currents to ground via the green safety Ground wire
- Provide a means for disconnecting AC power when the boat is not in use or in emergencies
- Provide electrical separation to insure that two sources of AC power are never connected
- Provide circuit protection for neutral and line wires in the AC main system
- Provide ground fault protection
- Provide ELCI overload or leakage fault protection

AC Wire Systems

The three most common AC systems used on boats are shown here. In all cases the ground, sometimes called safety ground to clarify its purpose and differentiate it from the DC ground or negative, is said to be a "normally non-current carrying wire." Its purpose is to provide the lowest resistance path for AC currents that have strayed from their proper containment in the normally current carrying hot and neutral wires. The ground wire is connected to the exterior conductive parts of AC devices that could be touched by a person during normal operation, and it conducts errant AC currents safely to ground rather than passing them through a human body. The ground wire is never passed through a circuit breaker.

120 Volt-60 Hz	120/240 Volt-60 Hz	230 Volt-50 Hz
Hot	Hot 1	Hot
Neutral	Hot 2	Neutral
Ground	Neutral	Ground
	Ground	

Devices Qualifying as AC Main Circuit Breakers

In order to qualify as an AC main circuit breaker, these characteristics must be present:

1. The circuit breaker must have an Amperage Interrupt Capacity (AIC) meeting the requirements of the following tables.
2. The circuit breaker must be multiple pole, usually 2 or 3.
3. The circuit breaker must be rated for the appropriate AC system voltage in which it will be used.
4. The circuit breaker must be available in amperages appropriate to the design amperage of the system. In the USA, this is generally 30A and 50A, while European systems are generally 16A and 32A.
5. The ELCI shall have a leakage trip mechanism that trips if current exceeding 30mA leaks to ground.

AC Shore Power Source	Main Circuit Breaker	Branch Circuit Breaker
120V - 30A	3,000	3,000
120V - 50A	3,000	3,000
120/240V - 50A	5,000	3,000
240V - 50A	5,000	3,000

Sources of AC power, whether shore power or onboard generators and inverters, should always have a circuit breaker near the power source. This circuit breaker is designated the AC main circuit breaker. The AC main circuit breaker should always have a pole for each of the hot and neutral wires in the circuit assuring that circuit protection functions are not compromised in reverse polarity situations. Beginning in July 2010 ABYC Standards require that an Equipment Leakage Circuit Interrupter (ELCI) with a 30mA leakage trip be installed in shore power applications as the first protective device after the power inlet. ELCIs respond to leakage of electrical current outside of the intended current path, and provide overload and short circuit protection. They serve as the main AC circuit breaker for the system. These devices will open all energized conductors and the neutral when opened manually or tripping on an overload or leakage fault. For a more complete discussion of ELCIs, see page 88.

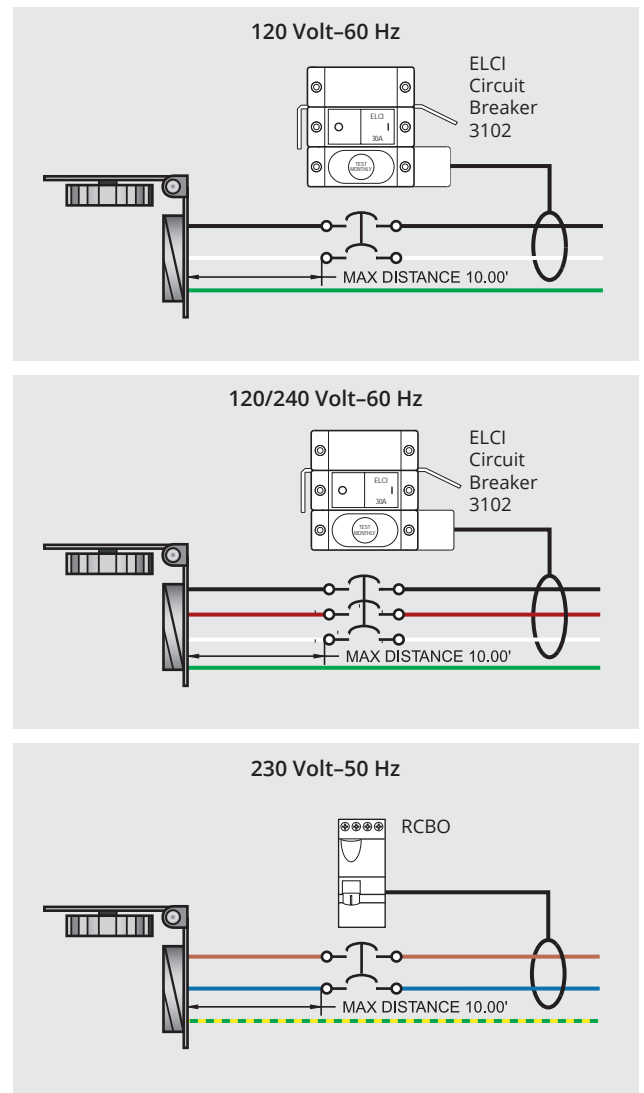

Marketing Materials

Blue Sea Systems offers sales and marketing materials that assist in promotion, and selection of products. For updated information and new marketing and sales materials, visit blueseas.com/marketing.

2021 Catalog

- 176 pages
- 25 catalogs per case
- Order individually



Part #	Description
20021	2021 Blue Sea Systems Catalog

You Can Do It Guides

- 20 guides per pack



20005

Part #	Description
20005	Design and Order a Custom Panel
20008	Protect Your Boat
20009	Add-A-Battery
20024	Install an ELCI Breaker

Logo Signs



20006



20036

Part #	Description
20006	Logo Sign 24" x 7"
20036	Logo Sign 11.5" x 4"

Window Decal



Part #	Description
9804	Window Decal 9" x 2.25"

Brushed Cotton Hats

- Adjustable strap
- One size fits all



20004

20003

Part #	Color
20004	Stone
20003	Navy Blue

Wire, Fuse and Fuse Holder Selection Chart

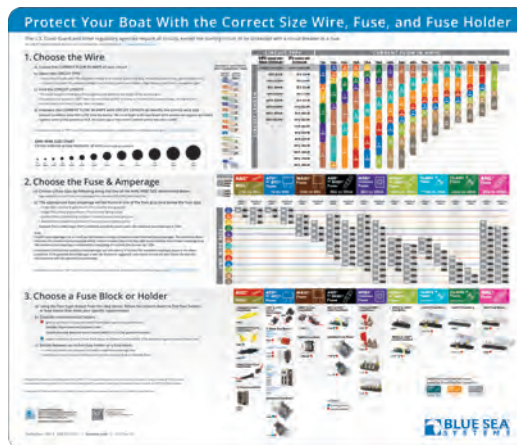

Part #	Description
20010	Deskmat 20" x 17"

Part #	Page	Part #	Page	Part #	Page	Part #	Page	Part #	Page
1001	111	1208	129	1480	131	1830	145	2102	108
1001100	111	1209	129	1481	130	1832	145	2103	108
1002	111	1210	126	1482	130	1833	145	2104	106
1002100	111	1211	126	1483	130	1836	145	2105	104
1003	111	1214	124	1484	130	1837	145	2107	106
1003100	111	1215	124	1485	130	1838	145	2126	104
1007	111	1216	120	1486	130	1839	145	2127	104
1007100	111	1217	121	1487	131	1841	145	2128	104
1010	27	1218	132	1488	131	1842	145	2129	77
1011	27	1219	132	1489	131	1850	145	2130	77
1011200	27	1221	122	1494	40	1850	146	2131	77
1012	27	1222	122	1495	120	1990	106	2132	77
1013	27	1223	121	1496	121	1991	106	2133	77
1014	27	1225	121	1497	120	1992	106	2134	77
1015	27	1227	121	1498	120	1993	106	2135	77
1016	26	1228	126	1499	154	20003	168	2136	77
1016200	26	1229	126	1502	128	20004	168	2137	77
1035	27	1230	124	1503	128	20005	168	2138	78
1036	27	1231	129	1504	128	20006	168	2139	78
1038	27	1232	129	1505	125	20008	168	2140	78
1039	26	1233	124	1510	151	20009	168	2141	78
1044	26	1331	154	1518	154	2001	108	2142	78
1045	26	1408	40	1520	96	20010	168	2143	78
1046	27	1450	120	1521	22	2002	108	2145	95
1070	154	1455	120	1522	96	20021	168	2146	95
11001	34	1456	120	1525	144	20024	168	2151	70
11003	36	1457	120	1732	147	2003	108	2155	95
1139	32	1459	120	1732200	147	20036	168	2201	108
1147	96	1461	121	1733	147	2010	108	2202	108
1148	96	1463	121	1733200	147	2011	108	2203	108
1168	127	1464	121	1739	147	2016	108	2204	108
1190	128	1472	27	1739200	147	2016100B	108	2300	103
1193	128	1473	142	1741	147	2017	108	2301	103
1200	121	1474	148	1741200	147	2017100B	108	2302	103
1201	122	1475	149	1810	146	2018	108	2303	103
1202	125	1477	80	1811	146	2018100B	108	2304	102
1203	125	1478	27	1820	151	2019	104	2305	102
1206	124	1479	154	1821	151	2020	104	2306	102
1207	124	1479100	154	1829	151	2101	108	2307	103

Part #	Page	Part #	Page	Part #	Page	Part #	Page	Part #	Page
2312	103	3001	36	4012	110	4180	97	5021	62
2314	102	3002	36	4013	110	4181	97	5021	62
2315	102	3003	36	4014	110	4190	97	5022	62
2340	107	3091	89	4015	110	4192	97	5022	62
2341B	107	3092	89	4016	110	4215	156	5023	65
2342B	107	3093	89	4017	110	4216	156	5024	65
2356	102	3102100	89	4018	110	4217	156	5025	68
2356100	102	3103	89	4019B	110	4218	156	5026	68
2402	105	3104	89	4020B	110	4230	97	5028	68
2404	105	3106100	89	4026	155	4302	117	5029	68
2406	105	3113	90	4027	155	4303	117	5030	68
2408	105	3116	90	4028	155	4304	117	5031	68
2410	105	3117	90	4029	155	4305	117	5032	67
2502	105	3118	90	4031	155	4306	117	5033	68
2504	105	3119	90	4100	155	4307	117	5034	68
2506	105	3120	90	4111	98	4308	117	5035	66
2508	105	3121	90	4112	98	4309	117	5037	66
2510	105	3122	91	4113	154	4320	115	5045	69
2512	105	3123	90	4116	98	4321	115	5046	69
2602	105	3124	91	4117	98	4322	115	5049	76
2604	105	3125	91	4119	98	4323	115	5050	76
2606	105	3126	91	4125	155	4324	115	5051	76
2608	105	3128	91	4126	155	4325	115	5052	76
2610	105	3130	91	4130	155	4363	28	5054	76
2701	103	3131	84	4131	155	4364	28	5056	64
2702	103	3133	91	4135	77	4365	28	5056100	64
2708	106	3134	91	4136	77	4366	28	5060	62
2709	103	3135	91	4137	77	4367	28	5061	62
2710	103	4000	110	4138	98	4368	28	5062	62
2713	102	4001	110	4150	98	4369	28	5063	62
2715	103	4002	110	4151	98	4374	117	5064	62
2716	103	4003	110	4152	98	4376	117	5064	62
2718	104	4004	110	4153	98	4378	117	5065	62
2719	104	4005	110	4154	98	5001	70	5065	62
2722	103	4006	110	4155	98	5005	71	5068	62
2723	103	4008	110	4160	97	5006100	63	5101	60
2730B	106	4009	110	4161	97	5007100	71	5102	60
2731B	106	4010	110	4162	97	5015	63	5103	60
3000	36	4011	110	4163	97	5018	63	5104	60

Part #	Page	Part #	Page	Part #	Page	Part #	Page	Part #	Page
5105	60	5178	60	5220	58	5256	60	5510E	34
5107	60	5180	60	5220100	58	5257	60	5511E	34
5108	60	5181	60	5226	58	5258	60	6004	32
5112	61	5182	60	5227	58	5259	60	6004200	32
5113	61	5183	60	5228	58	5260	60	6005	32
5114	61	5184	60	5229	58	5261	59	6005200	32
5115	61	5185	60	5230	58	5262	59	6006	32
5116	61	5186	60	5231	58	5263	59	6006200	32
5117	61	5187	60	5232	58	5264	59	6007	32
5118	61	5189	60	5233	58	5265	59	6007200	32
5119	61	5190	60	5234	58	5270	59	6008	32
5120	61	5191	70	5235	59	5271	59	6008200	32
5121	61	5194	70	5235100	59	5272	59	6010	32
5122	61	5196	70	5236	59	5273	59	6010200	32
5123	61	5201	58	5236100	59	5274	59	6011	32
5124	61	5202	58	5237	59	5275	58	6011200	32
5125	61	5204	58	5237100	59	5280	58	6337	131
5126	61	5204100	58	5238	59	5281	58	7035	81
5127	61	5205	58	5239	59	5282	58	7036	81
5128	61	5206	58	5239100	59	5283	58	7038	81
5129	61	5206100	58	5240	59	5284	58	7039	81
5131	61	5207	58	5240100	59	5285	58	7040	81
5133	61	5208	58	5241	59	5286	59	7041	81
5135	61	5208100	58	5241100	59	5287	59	7042	81
5136	61	5209	58	5242	59	5288	58	7043	81
5137	61	5210	58	5242100	59	5289	58	7044	81
5138	59	5210100	58	5243	59	5290	59	7046	81
5139	59	5211	58	5243100	59	5291	59	7047	81
5140	59	5212	58	5244	59	5292	59	7048	81
5141	59	5213	58	5244100	59	5293	59	7049	81
5142	59	5213100	58	5245	59	5294	59	7050	77
5143	59	5215	58	5245100	59	5295	59	7052	77
5161	61	5215100	58	5246	59	5296	59	7053	77
5163	61	5217	58	5250	60	5297	59	7054	77
5164	61	5217100	58	5251	60	5298	59	7056	77
5165	61	5218	58	5252	60	5299	59	7057	77
5175	60	5218100	58	5253	60	5502	71	7058	77
5176	60	5219	58	5254	60	5502100	71	7059	77
5177	60	5219100	58	5255	60	5503	71	7061	77

Part #	Page	Part #	Page	Part #	Page	Part #	Page	Part #	Page
7062	79	7180	80	7235	84	7348	84	7445	83
7063	79	7181	80	7236	84	7349	84	7446	83
7064	79	7182	80	7237	84	7350	86	7454	83
7065	79	7183	80	7238	84	7351	86	7455	83
7066	79	7184	80	7239	84	7352	86	7456	83
7067	79	7185	80	7240	84	7353	86	7457	83
7068	79	7186	80	7241	84	7354	86	7458	83
7080	80	7187	80	7242	84	7355	86	7459	83
7081	80	7188	80	7244	86	7365	86	7461	83
7082	80	7189	80	7246	86	7372	127	7462	83
7083	80	7197	84	7248	86	7399	85	7463	83
7084	80	7198	80	7250	86	7400	85	7464	83
7085	80	7200	84	7250I	86	7401	85	7465	83
7086	80	7201	84	7251	86	7402	85	7466	83
7087	80	7202	84	7254	86	7403	85	7467	83
7088	80	7204	84	7256	86	7404	85	7475	87
7089	80	7205	84	7258	86	7405	85	7476	87
7098	80	7206	84	7260	84	7406	85	7477	87
7135	81	7208	84	7267	86	7407	85	7480	96
7136	81	7209	84	7268	86	7408	85	7481	96
7138	81	7210	84	7269	86	7410	85	7482	96
7139	81	7212	84	7270	86	7411	85	7483	96
7140	81	7213	84	7271	86	7412	85	7484	96
7141	81	7214	84	7287	86	7413	85	7485	96
7142	81	7216	84	7288	86	7414	85	7490	96
7143	81	7217	84	7289	86	7415	85	7491	96
7144	81	7218	84	7290	86	7416	85	7492	96
7146	81	7220	84	7294	84	7417	85	7493	96
7147	81	7221	84	7295	84	7425	85	7494	96
7148	81	7222	84	7299	84	7427	85	7495	96
7149	81	7224	84	7310	82	7428	85	7504	29
7151	78	7225	84	7311	82	7429	85	7506	29
7152	78	7226	84	7312	82	7430	85	7507	29
7153	78	7228	84	7313	82	7433	85	7508	29
7154	78	7229	84	7314	82	7440	83	7509	29
7155	78	7230	84	7315	82	7441	83	7512	21
7156	78	7232	84	7316	82	7442	83	7517	22
7157	78	7233	84	7317	82	7443	83	7520	22
7160	78	7234	84	7347	84	7444	83	7531	21

Part #	Page	Part #	Page	Part #	Page	Part #	Page	Part #	Page
7532	21	7621	53	7824	23	7943	94	8079	124
7540	87	7621100	53	7825	23	7944	94	8080	40
7541	87	7622	53	7830	23	7945	94	8081	120
7542	87	7622100	53	7831	23	8003	142	8082	121
7543	87	7623	53	7832	23	8005	142	8084	132
7545	87	7623100	53	7833	23	8013	149	8086	133
7546	87	7635	42	7834	23	8015	142	8087	86
7547	87	7649	50	7840	23	8017	142	8088	86
7548	87	7649003	50	7841	23	8018	142	8089	86
7549	87	7650	50	7850	23	8019	142	8095	132
7554	87	7650003	50	7850001	23	8022	142	8096	120
7560	87	7653	51	7851	23	8023	121	8097	126
7561	87	7654	51	7851001	23	8025	120	8099	124
7563	87	7655	51	7860	23	8027	124	8100	128
7564	87	7700	45	7870	160	8028	142	8101	128
7565	87	7700100	45	7900	32	8029	124	8102	128
7568	87	7701	42	7900200	32	8030	156	8110	147
7574	85	7701100	42	7901	32	8031	156	8120	120
7575	85	7702	45	7901200	32	8032	129	8121	116
7577	85	7702100	45	7902	160	8033	155	8127	124
7580	87	7703	42	7903	32	8034	155	8129	124
7581	87	7703100	42	7903200	32	8037	98	8132	129
7583	87	7713	45	7910	20	8039	156	8134	155
7584	87	7713100	45	7911	20	8041	142	8143	124
7585	87	7717	45	7912	20	8043	124	8158	126
7588	87	7717100	45	7920	20	8051	148	8159	126
7601	48	7718	42	7921	20	8053	116	8161	129
7603	24	7718100	42	7928	94	8054	116	8165	127
7604	24	7719	42	7929	94	8058	126	8166	155
7605	24	7719100	42	7930	94	8059	126	8167	155
7606	24	7720	72	7931	94	8061	129	8169	155
7607	24	7721	72	7932	94	8066	155	8171	155
7608	24	7725	73	7933	94	8067	156	8172	155
7609	24	7748	73	7934	94	8068	122	8173	84
7610	49	7765	41	7935	94	8072	84	8174	125
7611	52	7820	23	7936	94	8073	151	8176	125
7615	43	7821	23	7937	94	8074	125	8177	124
7620	53	7822	23	7938	94	8076	125	8179	124
7620100	53	7823	23	7939	94	8077	124	8184	132

Part #	Page	Part #	Page	Part #	Page	Part #	Page	Part #	Page
8186	133	8253	142	8299	95	8462	129	8689	40
8195	132	8255	151	8300	94	8464	125	8690	40
8197	126	8256	151	8357	130	8465	125	8693	40
8199	124	8257	151	8358	130	8466	129	9001E	34
8200	98	8258	143	8359	130	8467	129	9002E	34
8204	98	8259	96	8361	131	8478	126	9003E	34
8205	98	8260	96	8363	131	8479	127	9004E	34
8206	98	8261	116	8365	130	8480	126	9009	130
8207	98	8262	116	8366	130	8485	125	9010	130
8208	98	8263	115	8367	130	8488	125	9011	130
8209	98	8264	123	8369	131	8489	129	9012	41
8210	98	8265	127	8371	116	8498	129	9019	131
8211	98	8266	96	8372	116	8499	129	9030B	110
8212	98	8267	96	8373	116	8505	124	9031B	110
8214	156	8268	96	8374	116	8506	125	9038B	110
8216	94	8271	116	8375	121	8507	125	9039B	110
8217	156	8272	116	8376	122	8508	133	9040B	110
8218	94	8273	116	8377	122	8509	124	9041B	110
8219	94	8274	116	8378	122	8511	126	9077	131
8220	94	8275	94	8379	122	8512	124	9093	131
8221	94	8278	95	8380	123	8521	116	9159	32
8222	94	8280	40	8381	123	8561	127	9160	45
8230	94	8282	94	8382	123	8562	129	9176B	110
8231	94	8283	94	8385	121	8564	125	9177B	110
8232	94	8284	94	8386	131	8565	125	9216	105
8233	94	8285	94	8401	120	8566	129	9217	105
8234	94	8286	94	8402	121	8567	129	9218	105
8235	148	8287	94	8403	122	8578	126	9228	151
8236	148	8288	94	8405	124	8579	127	9230	151
8237	149	8289	94	8406	125	8580	126	9231	151
8238	149	8290	94	8407	125	8585	125	9233	151
8240	142	8291	94	8408	133	8588	125	9353	143
8244	143	8292	94	8409	124	8589	129	9354	143
8245	143	8293	95	8410	149	8598	129	9630	143
8246	143	8294	95	8411	126	8599	129	9804	168
8247	149	8295	95	8412	124	8664	115		
8248	148	8296	95	8413	132	8665	115		
8251	148	8297	95	8421	116	8666	115		
8252	142	8298	95	8461	127	8686	40		

Ingress Protection (IP) Ratings Guide









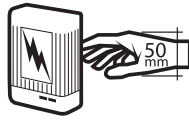

Example:

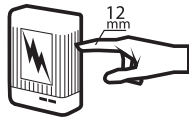
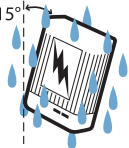
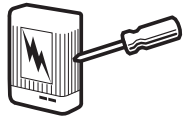
An IP65 rating can be determined using the adjacent table and example:

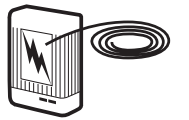
- The first number of the rating example, 6, in the gray column means the enclosure is dust tight
- The second number of the rating example, 5, in the blue column means the enclosure is protected against jets of water

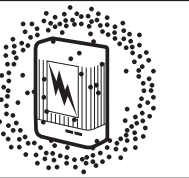
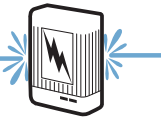
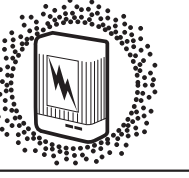
The IP rating system was established by the International Electrotechnical Commission (IEC), an organization for international standards and conformity assessment. The IEC collaborates closely with the International Organization for Standardization (ISO). A complete description of the IP ratings and associated tests is found in IEC Publication 529. Although these ratings were initially developed as a way to classify enclosures, they now provide a convenient, practical way to compare levels of sealing. Many electrical products have an Ingress Protection (IP) rating which identifies the environmental factors needing consideration prior to the product's installation.

This is important when deciding when to mount products in a dry and clean environment versus a wet and/or dusty environment. The IP rating indicates the degree of protection provided. The numbers following IP represent levels of sealing and can range from no protection to full protection against dust and water. The table provides a description of the protection at each level.

SOLIDS		WATER	
1	 <p>Protected against a solid object greater than 50 mm such as a hand.</p>	1	 <p>Protected against vertically falling drops of water. Limited ingress permitted.</p>
2	 <p>Protected against a solid object greater than 12 mm such as a finger.</p>	2	 <p>Protected against vertically falling drops of water with enclosure tilted up to 15 degrees from the vertical. Limited ingress permitted.</p>
3	 <p>Protected against a solid object greater than 2.5 mm such as a screwdriver.</p>	3	 <p>Protected against sprays of water up to 60 degrees from the vertical. Limited ingress permitted for three minutes.</p>
4	 <p>Protected against a solid object greater than 1 mm such as a wire.</p>	4	 <p>Protected against water splashed from all directions. Limited ingress permitted.</p>
5	 <p>Dust Protected. Limited ingress of dust permitted. Will not interfere with operation of the equipment. Two to eight hours.</p>	5	 <p>Protected against jets of water. Limited ingress permitted.</p>
6	 <p>Dust tight. No ingress of dust. Two to eight hours.</p>	6	 <p>Water from heavy seas or water projected in powerful jets shall not enter the enclosure in harmful quantities.</p>
		7	 <p>Protection against the effects of immersion in water between 15 cm and 1 m for 30 minutes.</p>
		8	 <p>Protection against the effects of immersion in water under pressure for long periods.</p>

Rating Example:

IP65

INGRESS PROTECTION

Blue Sea Systems

N85 12545 Westbrook Crossing
Menomonee Falls, WI 53051 USA
p 800.307.6702
p 800.222.7617 Blue Sea Systems
f 800.799.3779

New Zealand

42 Apollo Drive
Rosedale, Auckland 0632
New Zealand
p +64.9.415.7261
f +64.9.415.9327

The Netherlands

Snijdersbergweg 93
1105 AN Amsterdam
The Netherlands
p +31(0)20 34 22 100
f +31(0)20 69 71 006

techsupport@blueseas.com
blueseas.com

©2021 Blue Sea Systems, Inc
All rights reserved

Unauthorized copying or
reproduction is a violation
of applicable laws.

A division of



BSS_CAT_003_0820

